

505U



505U/RL



Declarations

Declaration of conformity 	When this pump unit is used as a stand alone pump it complies with: Machinery Directive 98/37/EC EN60204-1, Low Voltage Directive 73/23/EEC EN61010-1, EMC Directive 89/336/EEC EN50081-1/EN50082-1.
Declaration of Incorporation	When this pump unit is to be installed into a machine or is to be assembled with other machines for installations, it must not be put into service until the relevant machinery has been declared in conformity with the Machinery Directive 98/37/EC EN60204-1.

Responsible person: Dr R Woods, Managing Director, Watson-Marlow Limited, Falmouth, Cornwall TR11 4RU, England. Telephone 01326 370370 Fax 01326 376009.

R. Woods

Three year warranty

Watson-Marlow Limited warrants, subject to the conditions below, through either Watson-Marlow Limited, its subsidiaries, or its authorised distributors, to repair or replace free of charge, including labour, any part of this product which fails within three years of delivery of the product to the end user. Such failure must have occurred because of defect in material or workmanship and not as a result of operation of the product other than in accordance with the instructions given in this manual.

Conditions of and specific exceptions to the above warranty are:

- Consumable items such as tubing and rollers are excluded.
- Products must be returned by pre-arrangement carriage paid to Watson-Marlow Limited, its subsidiaries, or its authorised distributor.
- All repairs or modifications must have been made by Watson-Marlow Limited, its subsidiaries, or its authorised distributors or with the express permission of Watson-Marlow Limited, its subsidiaries, or its authorised distributors.
- Products which have been abused, misused, or subjected to malicious or accidental damage or electrical surge are excluded.

Warranties purporting to be on behalf of Watson-Marlow Limited made by any person, including representatives of Watson-Marlow Limited, its subsidiaries, or its distributors, which do not accord with the terms of this warranty shall not be binding upon Watson-Marlow Limited unless expressly approved in writing by a Director or Manager of Watson-Marlow Limited.

Information for returning pumps

Equipment which has been contaminated with, or exposed to, body fluids, toxic chemicals or any other substance hazardous to health must be decontaminated before it is returned to Watson-Marlow or its distributor.



A certificate included at the rear of these operating instructions, or signed statement, must be attached to the outside of the shipping carton.

This certificate is required even if the pump is unused. If the pump has been used, the fluids that have been in contact with the pump and the cleaning procedure must be specified along with a statement that the equipment has been decontaminated.

Safety

In the interests of safety, this pump and the tubing selected should only be used by competent, suitably trained personnel after they have read and understood this manual, and considered any hazard involved.

Any person who is involved in the installation or maintenance of this equipment should be fully competent to carry out the work. In the UK this person should also be familiar with the Health and Safety at Work Act 1974.

 	There are dangerous voltages (at mains potential) inside the pump. If access is required, isolate the pump from the mains before removing the cover.
---	---

Recommended operating procedures

DO keep delivery and suction lines as short as possible using a minimum number of swept bends.

DO use suction and delivery pipelines with a bore equal to or larger than the bore of the tube fitted in the pumphead. When pumping **viscous** fluids, the losses caused by increased friction can be overcome by using pipe runs with a cross sectional area several times greater than the pumping element.

DO run at a slow speed when pumping viscous fluids. When using the 501RL pumphead, a 4.8 or 6.4mm bore tube with a 1.6mm wall will give best results. Tube smaller than this will generate a high -friction pressure loss, so reducing the flow. Tube with a larger bore will not have sufficient strength to resist. Flooded suction will enhance pumping performance in all cases, particularly for materials of a viscous nature. Silicone and Marprene tubing is available with a 2.4mm wall thickness for speeds up to 200rpm. (The rotor will require re-setting to a roller/track gap of 3.8mm.)

DO fit an extra length of pump tube in the system to enable tube transfer. This will extend tube life and minimise the downtime of the pumping circuit.

DO keep the track and rollers clean.

The self-priming nature of peristaltic pumps means valves are not required. Any valves fitted must cause no restriction to flow in the pumping circuit.

When using Marprene tubing, after the first 30 minutes of running, re-tension the tube in the pumphead by releasing the tube clamp on the delivery side a little and pulling the tube tight. This is to counteract the normal stretching that occurs with Marprene which can go unnoticed and result in poor tube life.

Tube selection The chemical compatibility list published in the Watson- Marlow catalogue is only a guide. If in doubt about the compatibility of a tube material and the duty fluid, request a tube sample card for immersion trials.

Installation

The 505U/RL is suitable for single phase mains electricity supplies only.

To ensure correct lubrication of the gearbox the pump should be run only while its feet are standing on a horizontal surface. The pump should be positioned to allow a free flow of air around it.

- Set the voltage selector to either 120V for 100-120V 50/60Hz supplies or 240V for 220-240V 50/60Hz supplies.

A mains cable fitted with a moulded plug is supplied with the pump. The wires are colour coded in accordance with the following code:

- 220-240V: Live- Brown; Neutral - Blue; Earth - Green/Yellow.
- 100-120V: Live - Black; Neutral - White; Earth - Green.

Reduced voltage operation

In areas where voltage is below that specified above, modifications can be made to the pump unit to allow operation under the following minimum voltage levels:

- **180V when using the 220-240V setting.**
- **90V when using the 100-120V setting.**

The modification requires the connector J18 on the **Control PCB** to be reversed. To locate the terminal, isolate the mains supply then remove the pump cover. **State A** shows the standard voltage setting, whilst **State B** shows the reduced voltage setting. Any damage caused to the pump in the process of carrying out this modification will not be covered by warranty.

Control PCB



State A

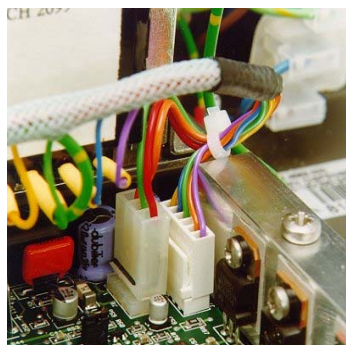

State B

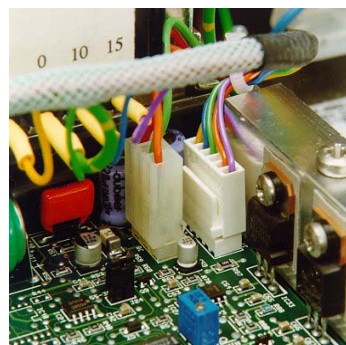

Refer servicing to qualified personnel only.

Troubleshooting

Should the pump fail to operate, make the following checks to determine whether or not servicing is required.

- Check that the power switch is on.
- Check the mains supply is available at the pump.
- Check the voltage selector switch is in the correct position.
- Check the fuse in the mains socket.
- Check that the pump is not stalled by incorrect fitting of tubing.

Manual operation

- Switch power on (drive rear panel).
- Press the **Man/Auto** key. When the **AUT** symbol is not flashing the pump is in manual mode.

- Change the set speed by pressing the \blacktriangle or \blacktriangledown key. The 505U speed control ratio is 110:1. This will give a minimum speed of 2rpm for the 220rpm drive and 0.5 rpm for the 55rpm drive.
- Change direction by pressing the **CW/CCW** key. Check the flashing **CW/CCW** symbol for actual direction setting. (**CW**: clockwise **CCW**: counterclockwise).
- Select the maximum speed: press the \blacktriangle key and the **Max** key together. Select the minimum speed: press the \blacktriangledown key and the **Max** key together.
- The keypad has a locking facility to avoid resetting or tampering. If the pump is stopped, press **Stop** until the padlock symbol illuminates. If the pump is running, press **Start** until the padlock symbol illuminates. All keys will be disabled except for **Start** and **Stop**. Press these keys until the padlock symbol extinguishes to unlock the keypad.
- The pump can be set to automatically restart in its operating state set prior to interruption, or set so that after power is reconnected the pump will remain stopped. To invoke the Auto-restart facility switch off power to the pump at the mains supply. Press the **Start** key down when the mains supply is switched back on until the ! symbol illuminates. Now press **Start** to start the pump. This facility can be cancelled by turning the mains supply off and then pressing the **Stop** key whilst turning the mains supply back on. The ! symbol will not be illuminated.
- Press **Start** to start the pump. Press **Stop** to stop the pump.

Automatic operation

Press the **Man/Auto** key. When the AUT symbol flashes the pump is in manual mode.

The pump is controllable by an analogue process signal of up to 30V or 32mA. The pump will provide an increasing flow rate for rising control signal (*non-inverted response*) or an increasing flow rate for falling control signal (*inverted response*).

- **Signal offset** is the process signal level which has to be reached in order for the pump rotor to start rotating.
- **Signal range** is the change in process signal level necessary to produce the required change in pump rotor speed.

For example, when using a 4mA to 20mA process signal:

Pump response	Signal offset	Signal range
Non-Inverted	4mA	16mA
Inverted	20mA	16mA

For voltage modes a stable variable DC voltage source can be used in conjunction with a DC voltmeter, (maximum 30V DC). (Refer to 25D pin connector wiring detail as an example of control circuitry) Circuit impedance 100 kohms. Polarity set for non-inverted response. Reverse polarity for inverted response.

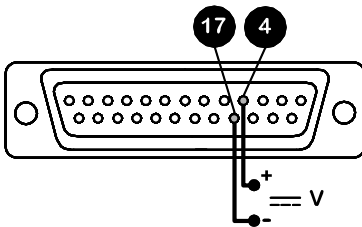

For current modes the same DC source can be used in conjunction with a DC milliammeter, (maximum 32mA). (See 25 pin Dee connector detail). Circuit impedance 250 ohms. Polarity set for non-inverted response. Reverse polarity for inverted response.

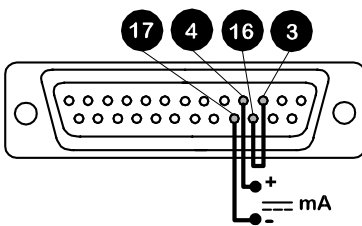

	<p>Never apply mains voltage across any pins on the 25D socket. Up to 30V may be applied across pins 4 and 17, and 5V TTL on pins 7 and 5, but no voltage should be applied across other pins. Permanent damage, not covered by warranty may result in both instances. Do not use the mains power switch to control the pump for a high repetition of stop/starts. The auto-control facility should be used.</p>
--	---

Calibration procedure

- Turn the signal offset potentiometer (marked "Offset" on back panel) clockwise until the slider traverse limit is reached and is signified by a clicking noise. Now turn the potentiometer ten turns anticlockwise. Repeat for the signal range potentiometer. This ensures correct potentiometer set up for calibration.
- Set the process signal offset.

- Turn the signal offset potentiometer clockwise to set the pump shaft speed to the desired minimum.
- Set the process signal at its upper range limit (not exceeding 30V or 32mA).
- Turn the signal range potentiometer (marked "Range" on back panel) clockwise to set the drive shaft speed to the desired maximum.

If the process signal or pump speed are set above their designated maximums the pump will be overloaded which is signified by the flashing of **AUT**. This is an indication of the limiting control and speed levels of the pump. Reset to operate within these levels.

- Repeat the procedure until pump response coincides exactly with the process signal.

Remote control

Stop/Start

Connect remote switch between pins 7 and 15 of the 25D connector. A TTL compatible logic input (Low 0v, High 5V) may be applied to pin 7. Low input stops the pump, high input runs the pump. With no connection, the pump will default to running.

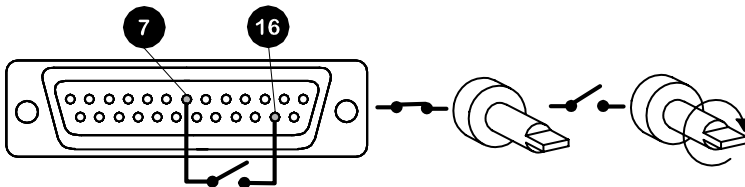

Direction

Connect remote switch between pins 5 and 16 and disable the front panel reversing control by linking pins 6 and 18 of the 25D connector. Open switch for clockwise rotation, close for counter-clockwise. Alternatively a TTL compatible logic input (Low 0, High 5V) may be applied to pin 5. Low input will run the pump in a counter-clockwise direction, High input in a clockwise rotation. No connection; the pump will default to clockwise rotation.

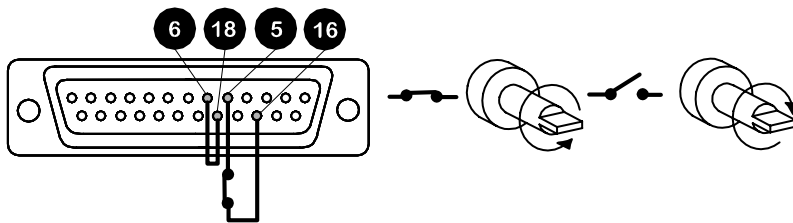

Speed

A remote potentiometer with a nominal value of between 1k and 2k with a minimum of 0.25W should be wired as shown. When using a remote potentiometer, do not apply a voltage/current control input signal at the same time. The speed control signal will require calibration relative to the minimum and maximum settings of the potentiometer. Use the offset and range potentiometers as described under calibration.

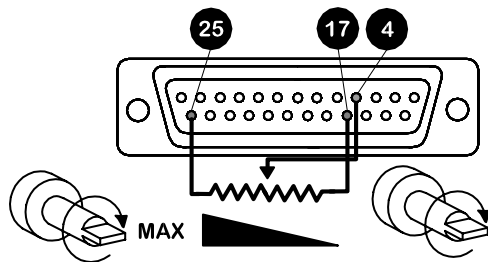

Strobe

The state of the pump may be monitored by utilising a 5V Hi Lo signal available at the 25D remote socket on the pump rear panel. The strobe line will change state as soon as the motor starts or stops.

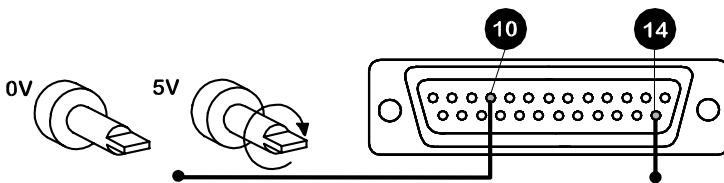

Tachometer output

This facility can be used to indicate motor speed or total the number of motor revolutions.

- 55rpm 2.937kHz

- 220rpm 4.71kHz

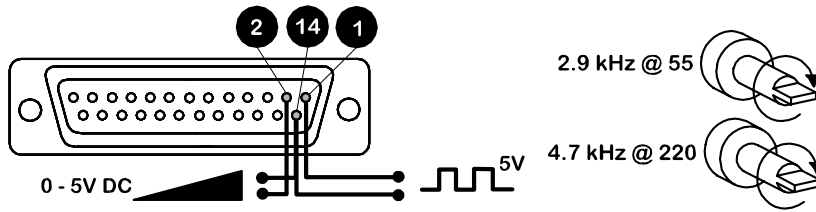

Learn and repeat

The 505U incorporates a Learn and Repeat feature, which enables a dose to be memorised and repeated. The dose volume is adjustable via the keypad. Full details are given in the Technical section.

Error messages

If a fault condition is detected in the drive unit it will stop, all keys will be disabled, and the display will flash:

ER1	Tachometer fault
ER2	Over temperature error
ER3	EEPROM error
ER4	EEPROM read error
ER5	EEPROM write error
ER6	EEPROM exhausted error. There is a maximum number of times the EEPROM can be written to. If ER5 is displayed, however, the EEPROM must be replaced.
ER9	RAM corruption error

Care and maintenance

The only scheduled maintenance of the 505U is to inspect the motor brushes and to replace them before their length is less than 6mm 1/4". The life of the brushes will depend on the duty of the pump, which is expected to be at least 10,000 hours at maximum speed. When the pump needs cleaning, remove the pumphead and use a mild solution of detergent in water. Do not use strong solvents.

If the gearbox is rebuilt you should use 15 ml of the recommended lubricant, which is RD105, this is a SAE 30 mineral oil loaded with molybdenum disulphide to form a soft fluid grease.

Specification

Maximum rotor speed	55, 220rpm
Voltage/frequency	100-120/220-240V 50/60Hz
Control range	110:1
Power consumption	100VA
Shaft Torque	2.2Nm
Operating temperature range	5 to 40C
Storage temperature range	-40C to 70C
Weight	7.7kg (17lb)
Noise	<70dBA at 1m
Standards	EN60529 (IP31) Machinery Directive 98/37/EC EN60204- 1 Low Voltage Directive 73/23/EEC EN61010- 1 EMC Directive:89/336/EEC EN50081-1 / EN50082-1

501RL Pumphead

The 501RL pumphead has two spring-loaded working rollers, which automatically compensate for minor variations in tubing wall thickness, giving extended tube life. The 501RL is set during manufacture to accept tubing with wall thicknesses of between 1.6mm and 2.0mm, and internal diameters of up to 8.0mm. It is equipped with a "tool lockable" guard for increased safety. This should be locked shut whilst the pump is in use.

The pumphead can be run clockwise for extended tube life, or anti-clockwise to operate against higher pressures.

Flow rates

Flow rates for the 505U were obtained using silicone tubing with the pumphead rotating clockwise, pumping water at 20C with zero suction and delivery pressures. For critical applications determine flow rates under operating conditions.

Installation

Fit the track in any one of three orientations, over the drive shaft and locating boss. Secure the track with the locating screw. Ensure the drive shaft is degreased before locating the rotor onto the shaft via the split collet. *Rotate the rotor until its guide rollers are aligned flush to the front edge of the track.* Tighten the rotor screw to a torque of 3Nm to prevent the collet slipping during operation.

To reposition the track, swing out the crank handle to expose the rotor retaining screw. Turn the screw anticlockwise one turn to release the collet, and withdraw the rotor from the shaft. Loosen the track locating screw, and pull the track clear. Rotate the track to its new position and tighten the track locating screw. Use this method of removal and fitting if cleaning is required.

Tube loading

Isolate pump from mains supply. Unlock and open the hinged guard and swing out the rotor crank handle until it locks into position. Select the length of tubing required, noting that approximately 240mm is required for the 501RL track.

Fit one end of the tubing into one of the spring loaded clamps, and then, whilst rotating the rotor with the crank handle, feed the tubing between the rollers and the track, aligning it within the rotor tube guides. The tubing must lie naturally against the track and must not be twisted or stretched.



Fit the other end of the tubing into the second spring loaded clamp, ensuring that the tubing is not slack in the pumphead, since this can reduce tube life.

Close the crank handle and shut and lock the guard.

After the pump has been started, open the downstream clamp for a short time, so that the tube can find its natural length.

The 501RL pumphead is fitted with four-position tube clamps, to accommodate various tube diameters, which can be adjusted by pushing in or pulling out the bars at the top of the upper clamp and the bottom of the lower clamp. Set the clamps so that the minimum necessary pressure is applied to the tubing.

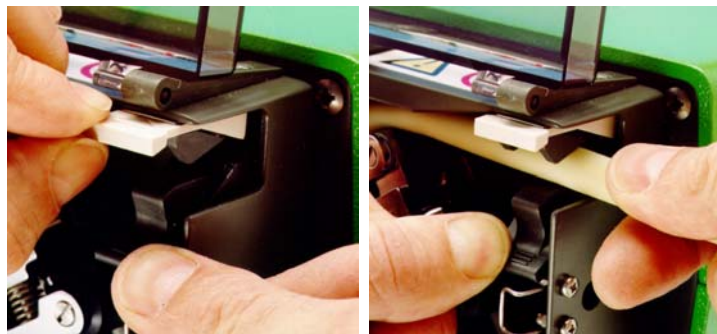

Roller adjustment

The 501RL has a factory set gap of 2.6mm between the rollers and the track and is suitable for tubing having wall thicknesses of between 1.6 and 2.0mm. Adjustment of the gap will be required if tubing having a wall thickness of less than 1.6mm is required. There is an adjusting screw on each of the two roller arms, and each of these screws will require adjustment. The correct gap is twice the wall thickness less twenty percent. Correct adjustment is important: over occlusion will reduce tube life; under occlusion will reduce pumping efficiency.

To change the gap setting, turn each adjusting screw clockwise to increase the gap, or anticlockwise to decrease the gap. A full turn changes the gap by 0.8mm.

To restore the original settings of 2.6mm, turn the adjusting screws until both rollers are just touching the track, then tighten each screw by three and a quarter turns. The 501RL2 has a factory set gap of 3.8mm between the wall and the track and is suitable for tubing having wall thickness of between 2.1 and 2.5mm.

Check moving parts of the rotor from time to time for freedom of movement. Lubricate pivot points and rollers occasionally with a light machine oil with Teflon additives. For scheduled maintenance, remove the rotor from the pumphead, clean thoroughly and apply light machine oil with Teflon additives to the roller spindles.

Specific drive performance details such as loaded drive speed variation against mains supply voltage fluctuation and drive stability from a cold start to normal operating temperature are available on request. For further information please contact Watson-Marlow Technical Support Department.

Pumphead spares

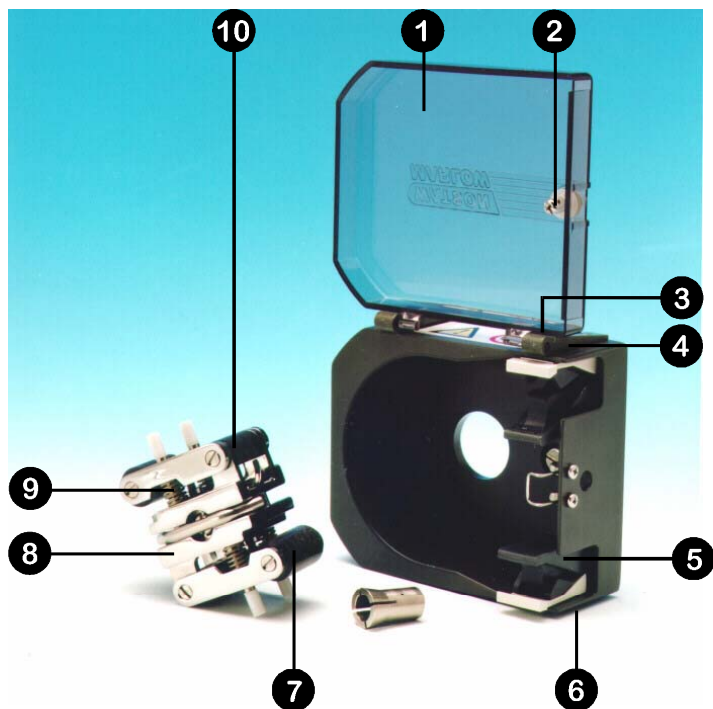

Number	Spare	Description
1	MN1200M	Lockable guard
2	FN4502	Lock screw
3	FN2341	Hinge screw
4	MN0266M	Hinge grey
5	MNA0114A	Tube clamp assembly
6	FN2332	Screw
7	MN0011T	Main roller
8	MNA0143A	501RL Rotor Assembly
9	SG0001/SG0002	Springs standard/hard
10	MN0012T	Follower roller
	XX0095	Teflon lubricant

Drive spares

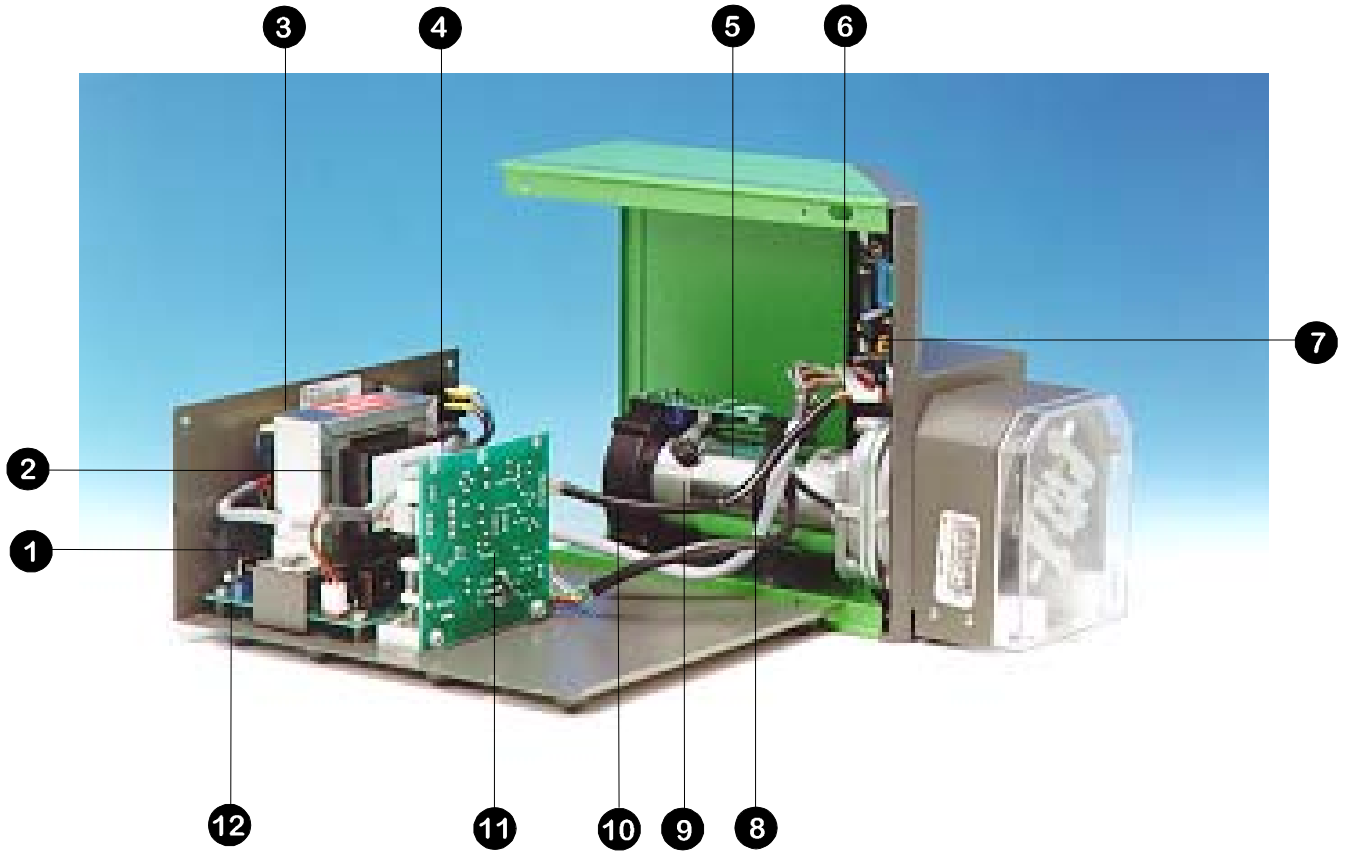

Number	Spare	Description
1	US 0045	Mains connector
2	TF 0031	Transformer
3	SW 0086	Voltage selector switch
4	SW 0147	On/Off switch
5	MNA0420A	Tachometer PCB
6	MNA0499A	Processor/Display PCB
7	MN 0550B	Keypad
8	MNA0388A	Motor/gearbox 220rpm
	MNA0396A	Motor/gearbox 55rpm
9	BM 0014	Motor brush
10	MN 0787M	Tachometer disc
11	MNA0422A	Speed control PCB
12	MNA0432A	Analogue PCB

English	User decision	Pump screen display	Terminal	Operation	Flow connector	Manual input

English	Instruction reference	Keypad function	Keypad function	Keypad function	Keypad function	Keypad function	Keypad function

Manual mode

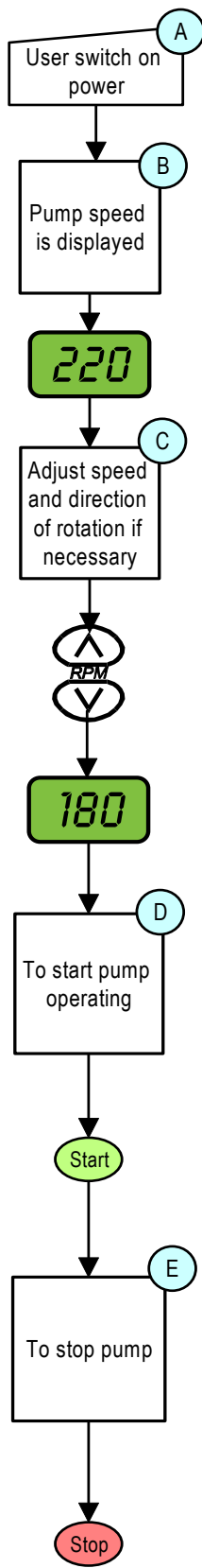

Learn and repeat mode

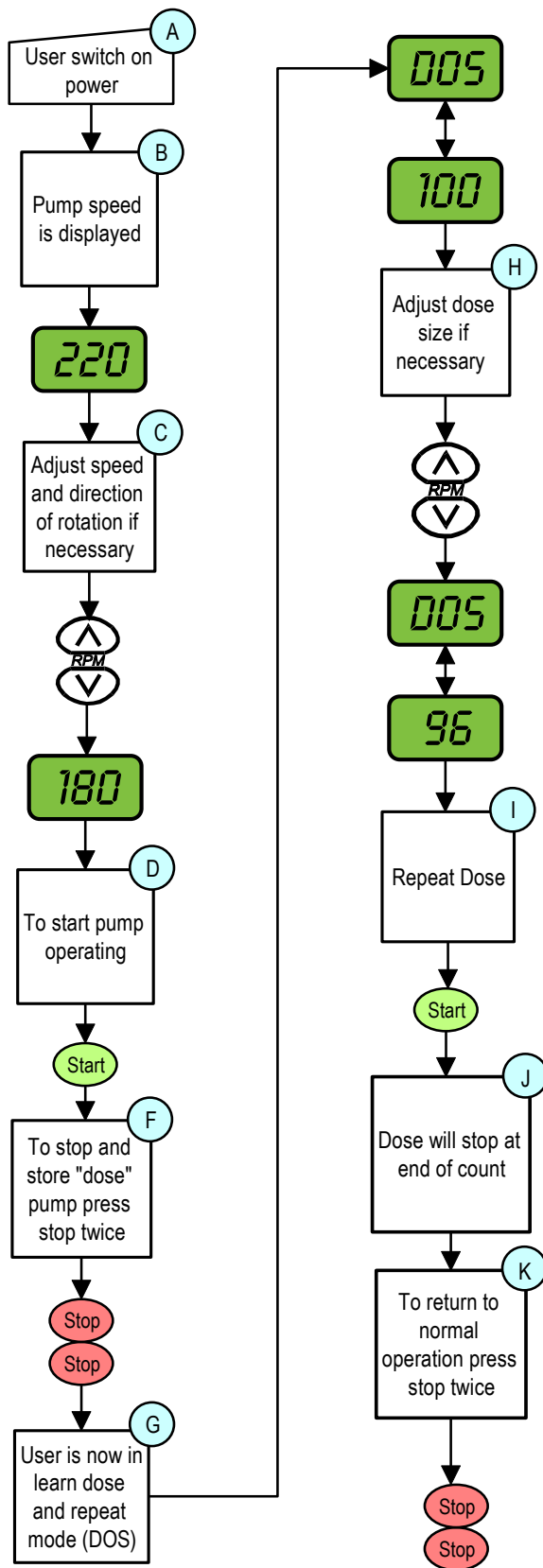

English

Manual Operation

- A User switch on power
- B When pump is switched on speed is displayed. (eg 220rpm)
- C Adjust speed and direction on pump keypad if necessary
- D Press **Start** to start pump
- E Press **Stop** to stop pump

Learn and Repeat Operation

Repeat steps A ⇔ C

D2 To set the required dose, begin by pressing start (as in manual mode).

- F When the required volume has been dispensed, press stop twice in quick succession. The pump is now in Learn and Repeat mode. The dose is now stored.
- G Learn and repeat mode is then shown by the display alternating between "dos" and "100". One hundred represents the total stored dose in %. The dose can be adjusted from 1% to 999% of the original stored dose.
- H Once adjusted the new dose count will be stored and represented with a new % of the original dose length. (eg 96%)
- I Repeat the dose using the start key (or footswitch on 505U, pins 7 and 14 of the 25D connector)
- J Pump will stop automatically when the dose is complete and await another start signal.
- K Press Stop twice in quick succession to return to normal operation, signified by a non-flashing speed display. If **Stop** is pressed twice approximately 2 seconds after **Stop** is pressed once in manual mode, then the previously stored dose can be recalled.

Dosing speed adjust

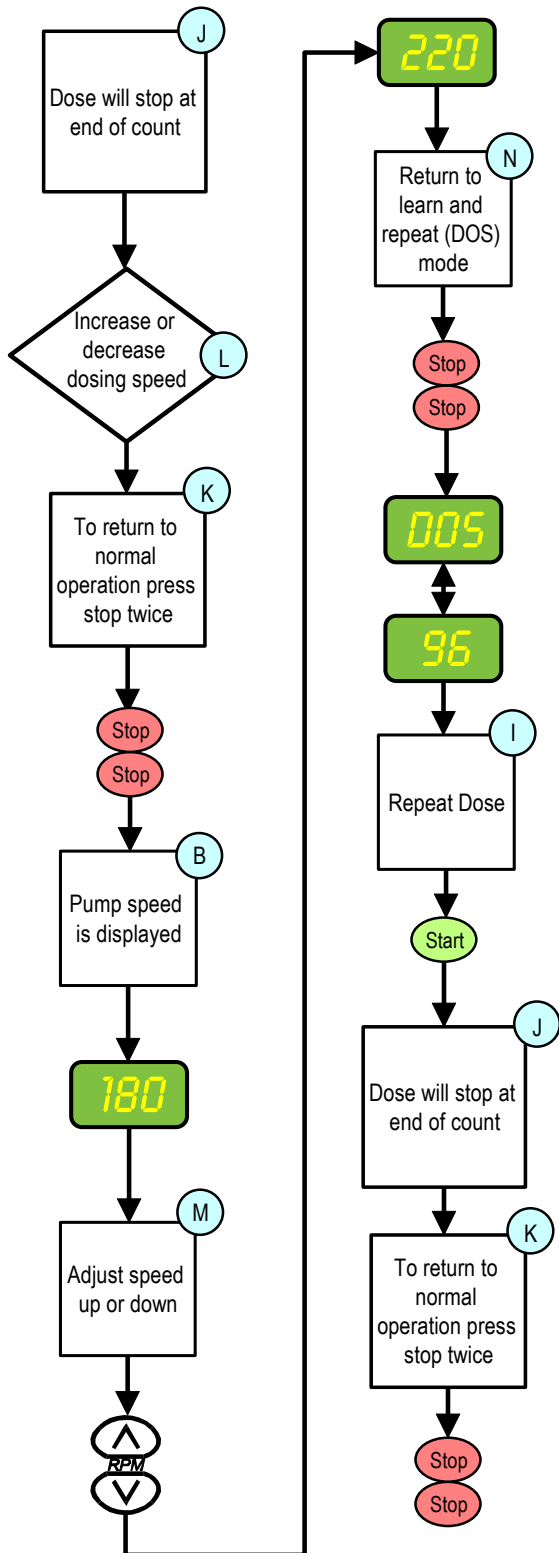

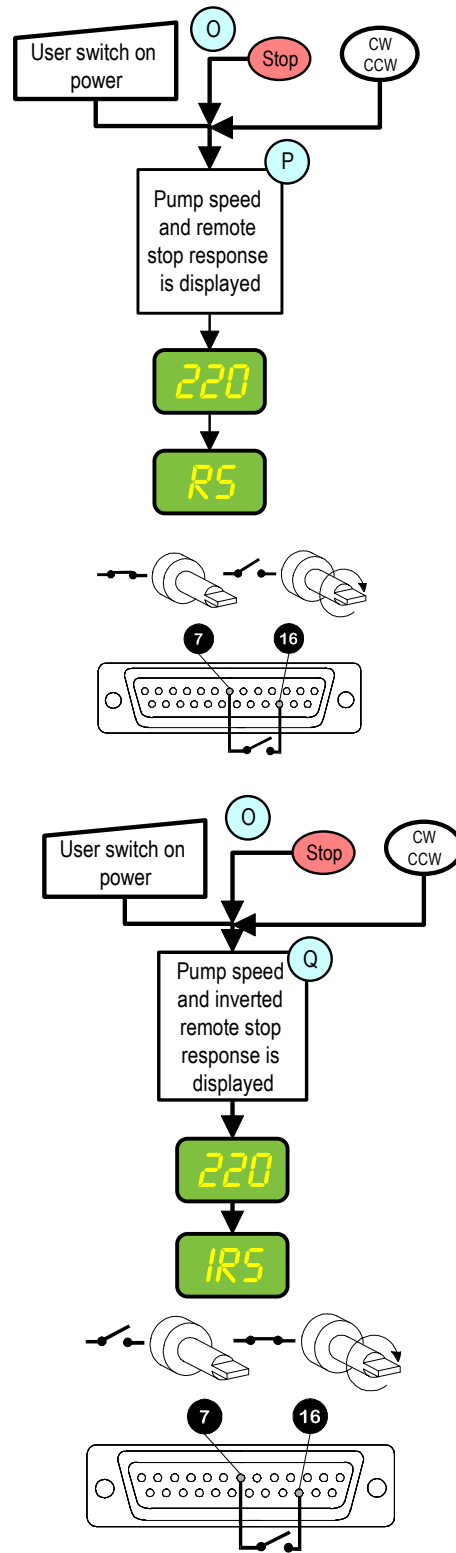

505U Remote stop/Inverted remote stop response



English

- L Decision to increase or decrease the completion speed of the dose
- M Adjust speed up or down when back in normal mode
- N Return to learn and repeat "dos" by pressing stop twice in quick succession
- O Simultaneously press Power on, Stop and CW/CCW key to display remote stop response
- P Pump display will alternate between set speed and remote stop response

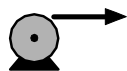
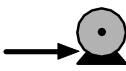
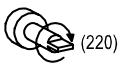
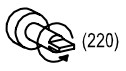
Q Pump display will alternate between set speed and inverted remote stop response

	#				
English	Tube number	Tube bore	Double-Y	Maximum cassettes	rpm
					
English	Pressure (+)	Suction	Clockwise (rpm)	Anticlockwise (rpm)	Stop

501RL, 501RL2 (ml/min)

Flow rates								
#	112	13	14	16	25	17	18	
mm	0.5	0.8	1.6	3.2	4.8	6.4	8.0	
"	1/50	1/32	1/16	1/8	3/16	1/4	5/16	
55	2.4	6.2	25	98	215	350	550	
220	9.7	25	100	395	870	1400	2200	

505L (ml/min)

Flow rates							
#	14	16	25	17	18	122	
mm	1.6	3.2	4.8	6.4	8.0	9.6	
"	1/16	1/8	3/16	1/4	5/16	3/8	
55	39	125	230	385	495	690	
220	154	500	920	1540	1980	2750	

505CA (ml/min)

Flow rates								
mm	0.13	0.19	0.25	0.38	0.50	0.63	0.76	
"	0.005	0.007	0.01	0.015	0.02	0.025	0.03	
55	0.027	0.07	0.16	0.27	0.44	0.79	1.155	
170	0.082	0.22	0.50	0.83	1.36	2.45	3.57	48
mm	0.88	1.02	1.14	1.29	1.42	1.47	1.52	
"	0.035	0.04	0.045	0.05	0.055	0.058	0.06	
55	1.54	2.04	2.57	3.22	3.82	4.14	4.37	
170	4.76	6.29	7.75	9.96	11.8	12.8	13.5	48
mm	1.65	1.85	2.05	2.38	2.54	2.79		
"	0.065	0.07	0.08	0.09	0.1	0.11		
55	5.05	6.30	7.60	9.84	11.0	12.84		
170	15.6	19.5	23.5	30.4	34.0	39.7		48

 : < 170

313/314 (ml/min)

Flow rates							
#	112	13	14	16	25	17	18
mm	0.5	0.8	1.6	3.2	4.8	6.4	8.0
"	1/50	1/32	1/16	1/8	3/16	1/4	5/16
313							
55	1.7	3.9	14	55	121	198	275
220	6.6	15	57	220	485	790	1100
314							
55	1.7	3.3	14	47	105	165	220
220	6.6	13	55	187	420	660	880

313

Maximum number of pumpheads														
313/314 Peroxide/ Platinum Silicone														
(0 ≤ bar ≤ 0.5)								(0.5 ≤ bar ≤ 2.0)						
#	112	13	14	16	25	17	18	112	13	14	16	25	17	18
mm	0.5	0.8	1.6	3.2	4.8	6.4	8.0	0.5	0.8	1.6	3.2	4.8	6.4	8.0
"	1/50	1/32	1/16	1/8	3/16	1/4	5/16	1/50	1/32	1/16	1/8	3/16	1/4	5/16
55	6	6	6	6	6	4	3	6	6	6	6	5	4	3
220	6	6	6	6	6	4	3	6	6	6	6	5	4	3
313/314 Marprene, Tygon, Neoprene, Fluorel														
(0 ≤ bar ≤ 0.5)								(0.5 ≤ bar ≤ 2.0)						
#	112	13	14	16	25	17	18	112	13	14	16	25	17	18
mm	0.5	0.8	1.6	3.2	4.8	6.4	8.0	0.5	0.8	1.6	3.2	4.8	6.4	8.0
"	1/50	1/32	1/16	1/8	3/16	1/4	5/16	1/50	1/32	1/16	1/8	3/16	1/4	5/16
55	6	6	6	6	5	3	3	6	6	6	6	4	3	3
220	6	6	6	6	5	3	3	6	6	6	5	4	3	3

501RL, 501RLG, 313

Product codes						
mm	"	#	Peroxide Silicone	Platinum Silicone	Marprene	Bioprene
0.5	1/50	112	910.0005.016	913.0005.016	902.0005.016	903.0005.016
0.8	1/32	13	910.0008.016	913.0008.016	902.0008.016	903.0008.016
1.6	1/16	14	910.0016.016	913.0016.016	902.0016.016	903.0016.016
3.2	1/8	16	910.0032.016	913.0032.016	902.0032.016	903.0032.016
4.8	3/16	25	910.0048.016	913.0048.016	902.0048.016	903.0048.016
6.4	1/4	17	910.0064.016	913.0064.016	902.0064.016	903.0064.016
8.0	5/16	18	910.0080.016	913.0080.016	902.0080.016	903.0080.016
mm	"	#	STA-PURE*	Gore fluoroelastomer*	Neoprene	Tygon
0.8	1/32	13			920.0008.016	
1.6	1/16	14	960.0016.016	965.0016.016	920.0016.016	950.0016.016
3.2	1/8	16	960.0032.016	965.0032.016	920.0032.016	950.0032.016
4.8	3/16	25	960.0048.016	965.0048.016	920.0048.016	950.0048.016
6.4	1/4	17	960.0064.016	965.0064.016	920.0064.016	950.0064.016
8.0	5/16	18	960.0080.016	960.0080.016	920.0080.016	950.0080.016
mm	"	#	Fluorel	Butyl **		
1.6	1/16	14	970.0016.016	930.0016.016		
3.2	1/8	16	970.0032.016	930.0032.016		
4.8	3/16	25	970.0048.016	930.0048.016		
6.4	1/4	17	970.0064.016	930.0064.016		
8.0	5/16	18	970.0080.016	930.0080.016		

* Use 501RLG

**Not suitable for use with 313 pumpheads

501RL2, 501RL2G

Product codes						
mm	"	Peroxide Silicone	Platinum Silicone	Marprene	Bioprene	STA-PURE*
1.6	1/16	910.0016.024	913.0016.024	902.0016.024	903.0016.024	960.0016.024
3.2	1/8	910.0032.024	913.0032.024	902.0032.024	903.0032.024	960.0032.024
4.8	3/16	910.0048.024	913.0048.024	902.0048.024	903.0048.024	960.0048.024
6.4	1/4	910.0064.024	913.0064.024	902.0064.024	903.0064.024	960.0064.024
8.0	5/16	910.0080.024	913.0080.024	902.0080.024	903.0080.024	960.0080.024
9.6	3/8	910.0096.024	913.0096.024	902.0096.024	903.0096.024	
mm	"	Gore fluoroelastomer*				
1.6	1/16	965.0016.024				
3.2	1/8	965.0032.024				
4.8	3/16	965.0048.024				
6.4	1/4	965.0064.024				
8.0	5/16	965.0080.024				
9.6	3/8					

* Use 501RL2G

505L, 505LG

(2.4mm) Product codes			Peroxide Silicone	Platinum Silicone	Marprene	STA-PURE	Gore fluoroelastomer	
mm	"	#						
1.6	1/16	119	910.E016.024	913.E016.024	902.E016.024	960.E032.K24	965.E032.K24	
3.2	1/8	120	910.E032.024	913.E032.024	902.E032.024	960.E032.K24	965.E032.K24	
4.8	3/16	15	910.E048.024	913.E048.024	902.E048.024	960.E048.K24	965.E048.K24	
6.4	¼	24	910.E064.024	913.E064.024	902.E064.024	960.E064.K24	965.E064.K24	
8.0	5/16	121	910.E080.024	913.E080.024	902.E080.024	960.E080.K24	965.E080.K24	
9.6	3/8	122	910.E096.024	913.E096.024	902.E096.024			
9.6	3/8	122	910.H096.024 (high flow element)					

501RL

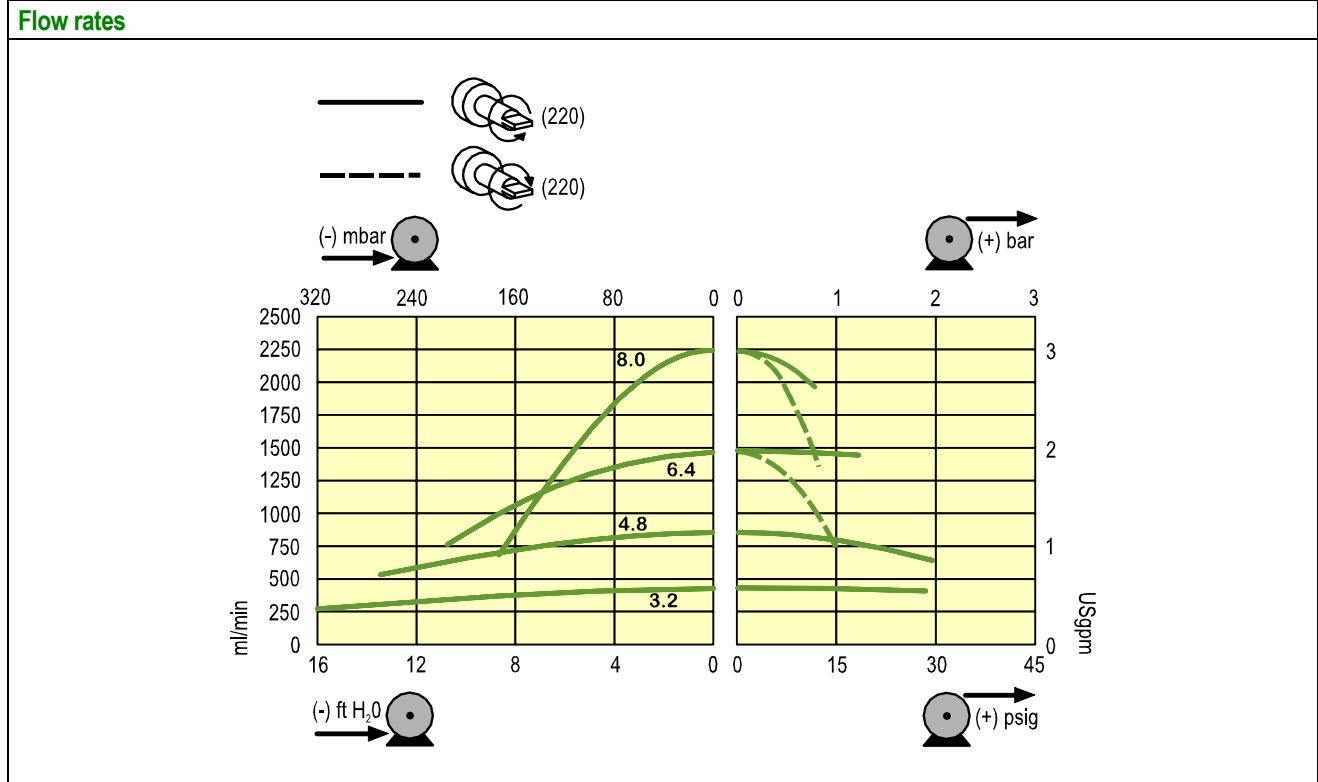

Outline dimensions

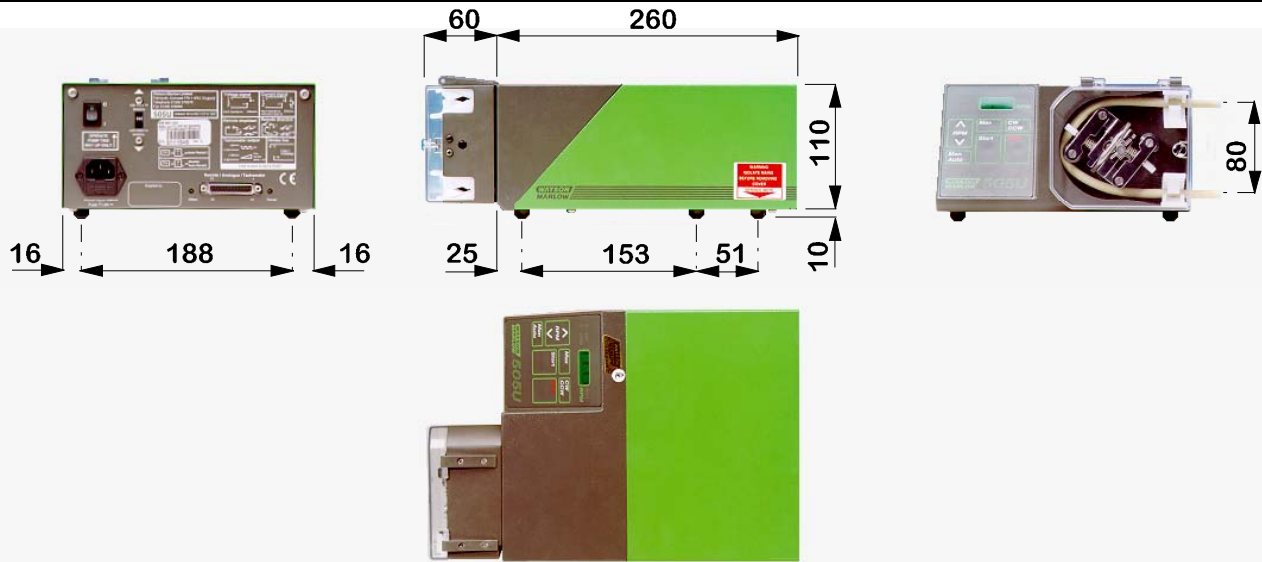

Product use and decontamination declaration

In compliance with the **UK Health & Safety at Work Act** and the **Control of Substances Hazardous to Health Regulations** you, the user are required to declare the substances which have been in contact with the product(s) you are returning to Watson-Marlow or any of its subsidiaries or distributors. Failure to do so will cause delays in servicing the product. Therefore, please complete this form to ensure that we have the information before receipt of the product(s) being returned. **A FURTHER COPY *MUST* BE ATTACHED TO THE OUTSIDE OF THE PACKAGING CONTAINING THE PRODUCT(S).** You, the user, are responsible for cleaning and decontaminating the product(s) before returning them.

Please complete a separate Decontamination Certificate for each pump returned. **RGA No:**

1 Company

Address Postcode
 Telephone Fax Number

2.1 Serial Number (a).....

2.2 Has the Product been used? (b).....

YES		NO	
-----	--	----	--

(c).....

(d).....

If yes, please complete all the following Sections. If no, please complete Section 5 only

3 Details of substances pumped

4 I hereby confirm that the only substances(s) that the equipment specified has pumped or come into contact with are those named, that the information given is correct, and the carrier has been informed if the consignment is of a hazardous nature.

3.1 Chemical names:

5 Signed

(a)..... Name
 (b)..... Position
 (c)..... Date
 (d).....

3.2 Precautions to be taken in handling these substances:

To assist servicing, please describe any fault condition(s) you have witnessed

(a).....
 (b).....
 (c).....
 (d).....

3.3 Action to be taken in the event of human contact:

(a).....
 (b).....
 (c).....
 (d).....

3.4 Cleaning fluid to be used if residue of chemical is found:

(a).....
 (b).....
 (c).....
 (d).....