

530 Bp/BpN Installation, operating, and maintenance manual

Contents

1 Declaration of conformity	4
2 Declaration of incorporation	5
3 When you unpack your pump	6
3.1 Unpacking your pump	6
3.2 Packaging disposal	6
3.3 Inspection	6
3.4 Components supplied	6
3.5 Storage	6
4 Information for returning pumps	7
5 Peristaltic pumps - an overview	7
6 Warranty	8
7 Safety notes	9
8 Pump specifications	12
8.1 Specification ratings	12
8.2 Weights	12
8.3 Pumphead options	13
9 Good pump installation practice	14
9.1 General recommendations	14
9.2 Dos and don'ts	15
10 Pump operation	16
10.1 Keypad Layout and Key IDs	16
10.2 Starting and stopping	17
10.3 Using up and down keys	17
10.4 Maximum speed	17
10.5 Change rotation direction	17
11 Connecting to a power supply	18
11.1 Conductor colour coding	19

11.2 Wiring the US NEMA module	19
11.3 Earth screening of control cables on NEMA module	19
12 Start-up check list	20
13 Control wiring	21
13.1 Upper D-connector	21
13.2 PROFIBUS	21
14 Switching the pump on for the first time	31
14.1 Selecting the display language	31
14.2 First-time start-up defaults	33
15 Switching the pump on in subsequent power cycles	35
16 Mode menu	36
17 Manual	37
17.1 START	37
17.2 STOP	38
17.3 INCREASING AND DECREASING FLOW RATE	38
17.4 MAX FUNCTION (Manual mode only)	39
18 Flow calibration	40
18.1 Setting the flow calibration	40
19 PROFIBUS mode	43
19.1 MODE menu	43
19.2 Manual mode operation when PROFIBUS is enabled	43
19.3 PROFIBUS mode	45
19.4 Assigning the PROFIBUS station address at the pump	47
19.5 PROFIBUS communication errors	48
19.6 PROFIBUS GSD file	50
20 Main menu	53
20.1 Security settings	54
20.2 General settings	63
21 Help	75
21.1 Help	75
22 Troubleshooting	76
22.1 Leak detection	77
22.2 Error codes	77

22.3 Technical support	78
23 Drive maintenance	79
24 Drive spares	80
25 Pumphead replacement	81
25.1 Pumphead replacement	81
26 Tube replacement	82
26.1 Continuous tubing	82
26.2 Tube elements	83
27 Ordering information	85
27.1 Pump part numbers	85
27.2 Tubing and element part numbers	86
27.3 Pumphead spares	90
27.4 Pumping accessories	91
28 Performance data	93
28.1 Performance curves	93
29 Trademarks	99
30 Disclaimers	100
31 Publication history	101

Original instructions

The original instructions for this manual have been written in English. Other language versions of this manual are a translation of the original instructions

1 Declaration of conformity



Watson-Marlow Limited
Falmouth
Cornwall
TR11 4RU
England

EC Declaration of Conformity

- 530 Cased pumps (Models: S, SN, U, UN, Du, DuN, Bp, BpN, En, EnN)
630 Cased pumps (Models: S, SN, U, UN, Du, DuN, Bp, BpN, En, EnN)
730 Cased pumps (Models: SN, UN, DuN, BpN, En, EnN)
- Manufacturer:
Watson Marlow Ltd
Bickland Water Road
Falmouth
TR11 4RU
UK
- This declaration of conformity is issued under the sole responsibility of the manufacturer
- All models and versions of the 530, 630 and 730 series of cased peristaltic pump with all approved pump heads, tubing and accessories.
- The object of the declaration described above is in conformity with the relevant Union harmonisation legislation:
Machinery Directive 2006/42/EC
EMC Directive 2014/30/EC
ROHS Directive 2015/863
- Harmonised standards used:
BS EN61010-1:2010 third edition Safety requirements for electrical equipment for measurement, control, and laboratory use Part 1: General requirements
EN61326-1:2013 Electrical equipment for measurement, control and laboratory use – EMC requirements Part 1: General requirements
BS EN 60529:1992+A2:2013 Degrees of protection provided by enclosures (IP code)
- Intertek Testing and Certification Ltd, No: 3272281, performed compliance testing to BS EN 61010-1:2010, IEC 61010-1:2010, UL 61010-1:2010 and CAN/CSA C22.2 Bo 61010-1:2010 and issued certification of compliance to these standards.

Signed for and behalf of:
Watson Marlow Ltd
Falmouth, November 2019

Simon Nicholson, Managing Director, Watson-Marlow Limited

2 Declaration of incorporation



Watson-Marlow Ltd
Falmouth
Cornwall
TR11 4RU
England

Declaration of Incorporation

In accordance with the Machinery Directive 2006/42/EC that if this unit is to be installed into a machine or is to be assembled with other machines for installations, it shall not be put into service until the relevant machinery has been declared in conformity.

We hereby declare that:

Peristaltic Pump

Series: 530, 630 and 730 cased pumps

the following harmonised standards have been applied and fulfilled for health and safety requirements:

Safety of Machinery – EN ISO 12100

Safety of Machinery – Electrical Equipment of Machines BS EN 60204-1

Quality Management System – ISO 9001

and the technical documentation is compiled in accordance with Annex VII(B) of the Directive.

We undertake to transmit, in response to a reasoned request by the appropriate national authorities, relevant information on the partly completed machinery identified above. The method of transmission shall be by mail or email.

The pump head is incomplete and must not be put into service until the machinery into which it is to be incorporated has been declared in conformity with the provisions of the Directive.

Person authorised to compile the technical documents:

Nancy Ashburn, Head of Design & Engineering, Watson-Marlow Ltd

Place and date of declaration: Watson-Marlow Ltd, 20.04.2020

Responsible person:

Simon Nicholson, Managing Director, Watson-Marlow Ltd

3 When you unpack your pump

3.1 Unpacking your pump

Unpack all parts carefully, retaining the packaging until you are sure all components are present and in good order. Check against the components supplied list, below.

3.2 Packaging disposal

Dispose of packaging materials safely, and in accordance with regulations in your area. The outer carton is made of corrugated cardboard and can be recycled.

3.3 Inspection

Check that all components are present. Inspect components for damage in transit. If anything is missing or damaged, contact your distributor immediately.

3.4 Components supplied

530 Components

- 530 pump drive unit, fitted with 520R2 or other pumphead if specified as a pump
- The designated power cable (attached to the pump drive unit)
- A 530N module providing pump ingress protection to IP66, NEMA 4X, if a BpN.
- **Note:** the module is attached for transit, but must be removed to allow wiring up, voltage selection and fuse inspection and then re-affixed before the pump is operated.
- Product safety information booklet incorporating quick start manual

3.5 Storage

This product has an extended shelf life. However, care should be taken after storage to ensure that all parts function correctly. Please observe the storage recommendations and use-by dates which apply to tubing you may wish to bring into service after storage.

4 Information for returning pumps

Before returning products, they must be thoroughly cleaned/decontaminated. The declaration confirming this should be completed and returned to us in advance of the item being shipped.

You are required to complete and return a decontamination declaration stating all fluids that have been in contact with the equipment being returned to us.

On receipt of the declaration, we will issue a Returns Authorisation Number. We reserve the right to quarantine or refuse any equipment that is not displaying a Returns Authorisation Number.

Please complete a separate decontamination certificate for each product and use the correct form that denotes the location you wish to return the equipment to. If you have any queries then please contact us for further assistance.

5 Peristaltic pumps - an overview

Peristaltic pumps are the simplest possible pump, with no valves, seals or glands to clog or corrode. The fluid contacts only the bore of a tube, eliminating the risk of the pump contaminating the fluid, or the fluid contaminating the pump. Peristaltic pumps can operate dry without risk.

How they work

A compressible tube is squeezed between a roller and a track on an arc of a circle, creating a seal at the point of contact. As the roller advances along the tube, the seal also advances. After the roller has passed, the tube returns to its original shape, creating a partial vacuum which is filled by fluid drawn from the inlet port.

Before the roller reaches the end of the track, a second roller compresses the tube at the start of the track, isolating a packet of fluid between the compression points. As the first roller leaves the track, the second continues to advance, expelling the packet of fluid through the pump's discharge port. At the same time, a new partial vacuum is created behind the second roller into which more fluid is drawn from the inlet port.

Backflow and siphoning do not occur, and the pump effectively seals the tube when it is inactive. No valves are needed.

The principle may be demonstrated by squeezing a soft tube between thumb and finger and sliding it along: fluid is expelled from one end of the tube while more is drawn in at the other.

Animal digestive tracts function in a similar way.

Suitable applications

Peristaltic pumping is ideal for most fluids, including viscous, shear-sensitive, corrosive and abrasive fluids, and those containing suspended solids. They are especially useful for pumping operations where hygiene is important.

Peristaltic pumps operate on the positive displacement principle. They are particularly suitable for metering, dosing and dispensing applications. Pumps are easy to install, simple to operate and inexpensive to maintain.

6 Warranty

Watson-Marlow Ltd ("Watson-Marlow") warrants this product to be free from defects in materials and workmanship for five years from the date of shipment, under normal use and service.

Watson-Marlow's sole responsibility and the customer's exclusive remedy for any claim arising out of the purchase of any product from Watson-Marlow is, at Watson-Marlow's option: repair, replacement or credit, where applicable.

Unless otherwise agreed in writing, the foregoing warranty is limited to the country in which the product is sold.

No employee, agent or representative of Watson-Marlow has the authority to bind Watson-Marlow to any warranty other than the foregoing unless in writing and signed by a director of Watson-Marlow. Watson-Marlow makes no warranty of the fitness of its products for a particular purpose.

In no event:

- i. shall the cost of the customer's exclusive remedy exceed the purchase price of the product;
- ii. shall Watson-Marlow be liable for any special, indirect, incidental, consequential, or exemplary damages, however arising, even if Watson-Marlow has been advised of the possibility of such damages.

Watson-Marlow shall not be liable for any loss, damage, or expense directly or indirectly related to or arising out of the use of its products, including damage or injury caused to other products, machinery, buildings, or property. Watson-Marlow shall not be liable for consequential damages, including without limitation, lost profits, loss of time, inconvenience, loss of product pumped, and loss of production.

This warranty does not obligate Watson-Marlow to bear any costs of removal, installation, transportation, or other charges which may arise in connection with a warranty claim.

Watson-Marlow shall not be responsible for shipping damage of returned items.

Conditions

- Products must be returned by pre-arrangement to Watson-Marlow, or a Watson-Marlow approved service centre.
- All repairs or modifications must have been made by Watson-Marlow Ltd, or a Watson-Marlow approved service centre or with the express permission in writing of Watson-Marlow, signed by a manager or director of Watson-Marlow.
- Any remote control or system connections must be made in accordance to Watson-Marlow recommendations.
- All PROFIBUS systems must be installed or certified by a PROFIBUS approved installation engineer.
- All EtherNet/IP™ systems must be installed or certified by a suitably trained installation engineer.

Exceptions

- Consumable items including tubing and pumping elements are excluded.
- Pumphead rollers are excluded.
- Repairs or service necessitated by normal wear and tear or by lack of reasonable and proper maintenance are excluded.
- Products which, in the judgement of Watson-Marlow, have been abused, misused, or subject to malicious or accidental damage or neglect are excluded.
- Failure caused by electrical surge is excluded.
- Failure caused by incorrect or sub-standard system wiring is excluded.
- Damage by chemical attack is excluded.
- Ancillaries such as leak detectors are excluded.
- Failure caused by UV light or direct sunlight.
- Any attempt to disassemble a Watson-Marlow product will invalidate the product warranty.

Watson-Marlow reserves the right to amend these terms and conditions at any time.

7 Safety notes

This safety information should be used in conjunction with the rest of this operating manual.

In the interests of safety, this pump and pumphead should only be used by competent, suitably trained personnel after they have read and understood the manual and considered any hazard involved. If the pump is used in a manner not specified by Watson-Marlow Ltd, the protection provided by the pump may be impaired. Any person who is involved in the installation or maintenance of this equipment should be fully competent to carry out the work. This person should also be familiar with all relevant health and safety protocols, regulations and guidance.



This symbol, used on the pump and in the manual, means: An appropriate safety instruction should be followed or caution to a potential hazard exists..



This symbol, used on the pump and in the manual, means: Do not allow fingers to contact moving parts.



This symbol, used on the pump and in the manual, means: Caution, hot surface.



This symbol, used on the pump and in the manual, means: Caution, risk of electric shock.



This symbol, used on the pump and in the manual, means: Personal Protective Equipment (PPE) must be worn.



This symbol, used on the pump and in the manual, means: Recycle this product under the terms of the EU Waste Electrical and Electronic Equipment (WEEE) Directive.



Within the 630 and 730 pumps there are thermal fuses which self-reset; if they trip, error code "Err17 Under Voltage" is displayed.





Fundamental work with regard to lifting, transportation, installation, starting-up, maintenance and repair should be performed by qualified personnel only. The unit must be isolated from mains power while work is being carried out. The motor must be secured against accidental start-up.



Some pumps weigh more than 18kg (the exact weight depends on the model and pumphead - see on the pump). Lifting should be performed according to standard Health and Safety guidelines. Finger recesses are built into the sides of the lower shell for convenience in lifting; in addition, the pump can conveniently be lifted by grasping the pumphead and (where fitted) the 'N' module at the rear of the pump.



There is a user-replaceable fuse located at the rear of the pump. Some country specific mains plugs contain an additional replaceable fuse. Fuses must be replaced with parts with the same rating.



There are no user-serviceable fuses or parts inside this pump.

Note - the mains power supply cable is supplied hardwired into the pump and is not customer replaceable.

Observe voltage selector switch setting for your region



IP66 pumps are supplied with a mains plug. The gland at the NEMA Module end of the cable is IP66 rated. The mains plug at the opposite end of the cable is NOT IP66 rated. It is the user's responsibility to ensure that the connection to the mains supply is IP66 rated.

This pump must be used only for its intended purpose.

The pump must be accessible at all times to facilitate operation and maintenance. Access points must not be obstructed or blocked. Do not fit any devices to the drive unit other than those tested and approved by Watson-Marlow. Doing so could lead to injury to persons or damage to property for which no liability can be accepted.

The pump's main plug is the disconnecting device (for isolating the motor drive from the mains supply in an emergency). Do not position the pump so that it is difficult to disconnect the mains plug.



If hazardous fluids are to be pumped, safety procedures specific to the particular fluid and application must be put in place to protect against injury to persons.



This product does not comply with the ATEX directive and must not be used in explosive atmospheres.



Ensure the chemicals to be pumped are compatible with the pumphead, lubricant (where applicable), tubing, pipework and fittings to be used with the pump. Please refer to the chemical compatibility guide which can be found at: www.wmftg.com/chemical. If you need to use the pump with any other chemical please contact Watson-Marlow to confirm compatibility.



If the Auto restart feature is enabled it may cause the pump to start as soon as power is turned on.

Auto-restart only affects operation of manual mode, network mode and memodose mode.



If Auto restart is enabled the "!" Symbol is shown on the screen to warn users that the pump may operate without any manual intervention (pump resumes with previous settings).

Do not use auto restart for more than 20 mains power starts per hour . We recommend remote control where a high number of starts is required.



If the pump is configured to network mode or analog mode it will respond to remote commands at any time including immediately after power on. The "!" Symbol is shown on the screen to warn users that the pump may operate without any manual intervention (e.g. a remote setpoint could start the pump with no key press required).



There are moving parts inside the pumphead. Before opening the tool-unlockable guard or tool-unlockable track, ensure that the following safety directions are followed:



1. Ensure the pump is isolated from the mains power.

2. Ensure that there is no pressure in the pipeline.



3. If a tube failure has occurred, ensure that any fluid in the pumphead has been allowed to drain to a suitable vessel, container or drain.

4. Ensure that appropriate Personal Protective Equipment (PPE) is worn.



Primary operator protection from rotating parts of the pump is provided by the pumphead safeguard. Note that safeguards differ, depending on the type of pumphead. See the pumphead section of the manual.

8 Pump specifications

8.1 Specification ratings

Operating temperature	5C to 40C (41F to 104F)
Storage temperature	530: -40C to 70C (-40F to 158F)
Humidity (non-condensing)	80% up to 31C (88F) decreasing linearly to 50% at 40C (104F)
Maximum altitude	2000m (6560ft)
Power Rating	530: 135VA
Supply voltage	100-120V/200-240V 50/60Hz 1pH (Subject to regional cord sets and supply)
Maximum voltage fluctuation	+/-10% of nominal voltage. A well regulated electrical mains supply is required along with cable connections conforming to the best practice of noise immunity.
Full load current	530: <0.6A@ 230V; <1.25A @ 115V
Fuse rating	T2.5AH250V (5x20mm)
Installation category (overvoltage category)	II
Pollution degree	2
IP	530: IP31 to BS EN 60529, if supplied with N module then IP66 to BS EN 60529. Equivalent to NEMA 4X to NEMA 250 *(indoor use - protect from prolonged UV exposure)
dB rating 	530: < 70dB (A) @ 1m
Control ratio	530: 0.1-220rpm (2200:1)
Maximum speed	530: 220rpm

8.2 Weights

530	Drive only		+ 520R, 520R2		+ 520REL, 520REM, 520REH		+ 505L	
IP31	9.7kg	21lb 6oz	10.6kg	23lb 5oz	10.5kg	23lb 3oz	12.2kg	26lb 14oz
IP66	10.6kg	23lb 5oz	11.5kg	25lb 5oz	11.4kg	25lb 2oz	13.1kg	28lb 13oz



Some pumps weigh more than 18kg (the exact weight depends on the model and pumphead - see on the pump). Lifting should be performed according to standard Health and Safety guidelines. Finger recesses are built into the sides of the lower shell for convenience in lifting; in addition, the pump can conveniently be lifted by grasping the pumphead and (where fitted) the module at the rear of the pump.



8.3 Pumphead options

530 pump range

520R, 520R2, 520REH, 520REL, 520REM, 505L, 505CA, 313, 314, 314MC and 318MC.



9 Good pump installation practice

9.1 General recommendations

It is recommended that the pump is sited on a flat, horizontal, rigid surface, free from excessive vibration, to ensure the correct lubrication of the gearbox and correct pumphead operation. Allow a free flow of air around the pump to ensure that heat can be dissipated. Ensure that the ambient temperature around the pump does not exceed the recommended maximum operating temperature.

The STOP key on pumps supplied with a keypad will always stop the pump. However, it is recommended that a suitable local emergency stop device is fitted into the mains supply to the pump.

Do not stack the pumps more than the recommended maximum number. When the pumps are stacked, ensure that the ambient temperature around all the pumps in the stack does not exceed the recommended maximum operating temperature.



The pump may be set up so that the direction of rotor rotation is clockwise or counter-clockwise, whichever is convenient.

Please note, however, that for some pumpheads the tube life will be greater if the rotor rotates clockwise; and that performance against pressure will be maximised if the rotor rotates counter-clockwise. To achieve pressure in some pumpheads the pump must rotate counter-clockwise.

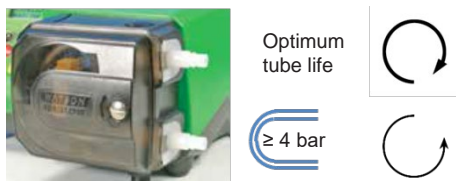

Peristaltic pumps are self-priming and self-sealing against backflow. No valves are required in inlet or discharge line, except those specified as below.



Users must fit a non-return valve between the pump and the discharge pipework to avoid the sudden release of pressurised fluid in the event of a pumphead or tube failure. This shall be fitted immediately after the discharge of the pump.

Valves in the process flow must be opened before the pump operates. Users are advised to fit a pressure relief device between the pump and any valve on the discharge side of the pump to protect against damage caused by accidental operation with the discharge valve closed.

9.2 Dos and don'ts

- Do not build a pump into a tight location without adequate airflow around the pump.
- Do keep delivery and suction tubes as short and direct as possible - though ideally not shorter than one metre - and follow the straightest route. Use bends of large radius: at least four times the tubing diameter. Ensure that connecting pipework and fittings are suitably rated to handle the predicted pipeline pressure. Avoid pipe reducers and lengths of smaller bore tubing than the pumphead section, particularly in pipelines on the suction side. Any valves in the pipeline must not restrict the flow. Any valves in the flow line must be open when the pump is running.
- Do ensure that on longer tube runs at least one metre of smooth bore, flexible tubing is connected to the inlet and discharge port of the pumphead to help to minimise impulse losses and pulsation in the pipeline. This is especially important with viscous fluids and when connecting to rigid pipework.
- Do use suction and delivery pipes equal to or larger than the tubing diameter bore. When pumping viscous fluids use pipe runs with a bore several times larger than the pump tube.
- Do site the pump at or just below the level of the fluid to be pumped if possible. This will ensure flooded suction and maximum pumping efficiency.
- Do run at slow speed when pumping viscous fluids. Flooded suction will enhance pumping performance, particularly for materials of a viscous nature.
- Do recalibrate after changing tubing, fluid or any connecting pipework. It is also recommended that the pump is recalibrated periodically to maintain accuracy.
- Do not pump any chemical not compatible with the tube or pumphead.
- Do not run the pump with no tube or element fitted to the pumphead.
- Do not strap the control and mains cables together.
- Do ensure if your product has an N module, that the module is fitted with the seals intact and properly located. Ensure that the holes for the cable glands are properly sealed to maintain the IP/NEMA rating.
- If your pump is a PROFIBUS variant do ensure that it is installed in accordance with PROFIBUS installation guidelines.
- Do not allow tight bends in any PROFIBUS signal cable.

Tube selection: The chemical compatibility guide published on the Watson Marlow website is for guidance. If in any doubt about the compatibility of a tube material and the duty fluid, request a Watson-Marlow tube sample card for immersion trials.

When using Marprene or Bioprene continuous tubing, do re-tension the tube after the first 30 minutes of running.

10 Pump operation

10.1 Keypad Layout and Key IDs

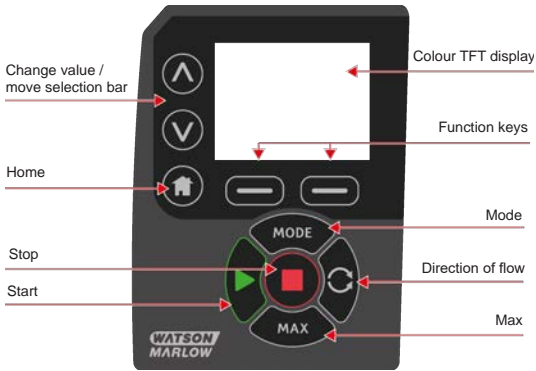

HOME key

When the HOME key is pressed it will return the user to the last known operating mode. If modifying pump settings when the HOME key is pressed, it will disregard any setting changes and return you to the last known operating mode.

FUNCTION keys

FUNCTION keys, when pressed, will perform the function displayed on the screen directly above the relevant function key.

^ and v keys

These keys are used to change the programmable values within the pump. These keys are also used to move the selection bar up and down in the menus.

MODE key

To change modes or mode settings, press the MODE key. The MODE key can be pressed at any time to enter the mode menu. If modifying pump settings when the MODE key is pressed, it will disregard any setting changes and return you to the MODE menu.

10.2 Starting and stopping



10.3 Using up and down keys



10.4 Maximum speed



10.5 Change rotation direction

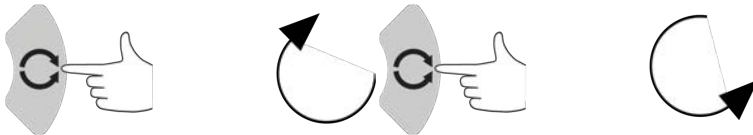

11 Connecting to a power supply

A well regulated electrical mains supply is required along with cable connections conforming to the best practice of noise immunity. It is not recommended to site these drives alongside electrical devices that may generate mains-borne noise, for example 3-phase contactors and inductive heaters.



Set the voltage selector to 115V for 100-120V 50/60Hz supplies or 230V for 200-240V 50/60Hz supplies. Always check the voltage selector switch before connecting to the mains supply or the pump will be damaged.

~100-120V



~200-240V



Make suitable connection to an earthed single-phase mains electricity supply.



If the pump type is one with an 'N' module, the voltage selector is not visible while the module is in place. It is mounted in the switch plate at the rear of the pump, protected from water by the 'N' module. The module must be removed to allow access to the switch plate. Do not switch the pump on unless you have checked that it is set to suit your power supply by removing the module and inspecting the switch and then refitting the module.



1.



2.



3.



4.



We recommend using a commercially available supply voltage surge suppression where there is excessive electrical noise.



Ensure that all power supply cables are adequately rated for the equipment. Only use with supplied power cable.



The pump must be positioned so that the disconnection device is easily accessible when the equipment is in use.



IP66 pumps are supplied with a mains plug. The gland at the NEMA Module end of the cable is IP66 rated. The mains plug at the opposite end of the cable is NOT IP66 rated. It is your responsibility to ensure that the connection to the mains supply is IP66 rated.

11.1 Conductor colour coding

Conductor type	European colour	North American colour
Line	Brown	Black
Neutral	Blue	White
Ground	Green/Yellow	Green

11.2 Wiring the US NEMA module

The NEMA 4X modules fitted to 530, 630 and 730 Du, S, U and PROFIBUS cased pumps with part numbers ending with an A (xxx.xxxx.xxA) have two pairs of wiring ports. Two M16 ports are provided, together with glands to seal circular cross-section cables ranging in diameter from 4mm to 10mm (5/32in to 13/32in); two M20 ports are provided, together with glands to seal circular cross-section cables ranging in diameter from 10mm to 14mm (13/32in to 9/16in) rated for IP66 minimum.

Four adaptors are also supplied: two M16 male to 3/8in NPT female; and two M20 male to 1/2in NPT female. These can be used to fit flexible conduit systems where NPT threads are required.

11.3 Earth screening of control cables on NEMA module

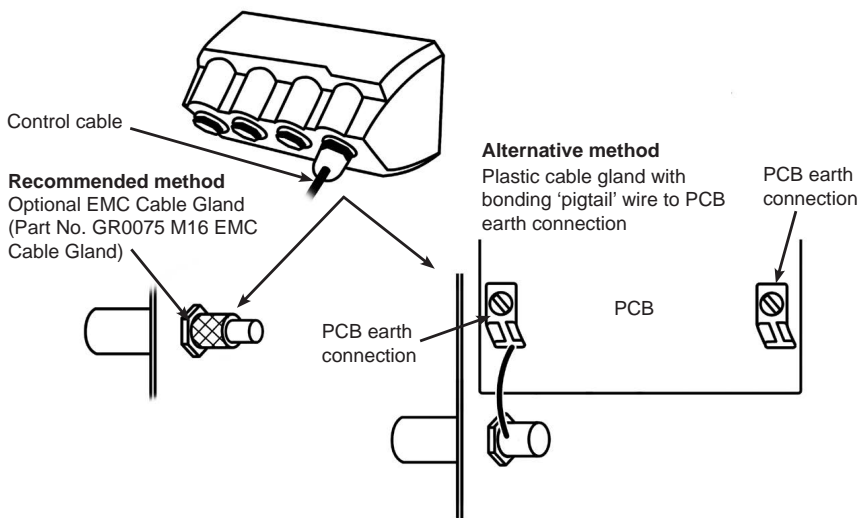

12 Start-up check list

Note: See also "Tube replacement " on page 82.

- Ensure that proper connections are achieved between the pump and suction and discharge piping.
- Ensure proper connection has been made to a suitable power supply.
- Ensure that the recommendations in the section "Good pump installation practice " on page 14 are followed.

13 Control wiring



Never apply mains power to the D-connectors. Apply the correct signals to the pins shown. Limit signals to the maximum values shown. Do not apply voltage across other pins. Permanent damage, not covered by warranty, may result.



Keep 4-20mA and low voltage signals separate from mains power. Use separate glanded input cables. Following best EMC practice and use of shielded glands is recommended.



Ensure that multi-strand wires are terminated with a crimp suitable to the wire diameter, (applies to NEMA or SCADA model connections only, not sub-D connector type terminations). Failure to do so may result in electric shock.

13.1 Upper D-connector

Recommended control cable: 7/0.2mm 24AWG screened. Cable screen should be earthed with a 360 deg connection to a conductive back-shell. This will be connected to pump mains EARTH via the D connector body. Mains Earth is also available on pin 1 Upper D and pin 13 Lower D.

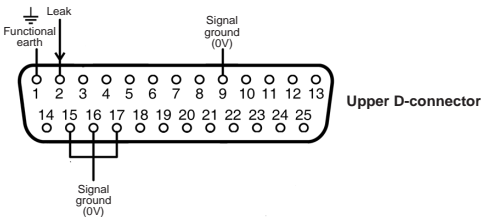

13.2 PROFIBUS

PROFIBUS 9 way D Connector. Cable suitable for use in a PROFIBUS DP installation must be used.

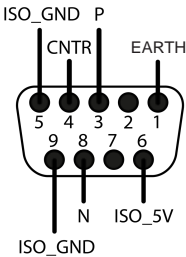

The PROFIBUS pump can be integrated into a PROFIBUS DP V0 network using a General Station Data (GSD) file. The file identifies the pump and contains key data including its communication settings, the commands it can receive and the diagnostic information it can pass to the PROFIBUS master on interrogation.

Note: The data flow to and from the pump may need to be byte reversed, due to the differences of handling between suppliers of master devices.

The GSD file, file name WAMA0F70.GSD can be found at our website wmftg.com.

User parameter data

The user parameter data is set by entering values into the 'Ext_User_Prm_Data_Const(0)' line of the GSD file. This is indicated below and the relevant bytes are listed in the table. No further changes should be made to the GSD file and Watson-Marlow accepts no responsibility for the pump failures arising from the changes to the GSD file.

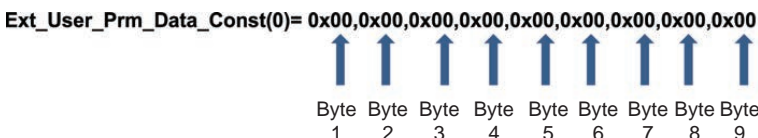

8 bit	Byte 1	Pre-assigned
8 bit	Byte 2	Head type
8 bit	Byte 3	Min speed (high byte of 16-bit unsigned)
8 bit	Byte 4	Min speed (low byte of 16-bit unsigned)
8 bit	Byte 5	Max speed (high byte of 16-bit unsigned)
8 bit	Byte 6	Max speed (low byte of 16-bit unsigned)
8 bit	Byte 7	Fail safe mode configuration
8 bit	Byte 8	Fail safe speed (high byte of 16-bit unsigned)
8 bit	Byte 9	Fail safe speed (low byte of 16-bit unsigned)

Examples: Ext_User_Prm_Data_Const(0) =

Pump type	Pump head	Fieldbus min speed set seed (high byte)	Fieldbus min speed set seed (Low byte)	Fieldbus Max speed (high byte)	Fieldbus Max speed (low byte)	Fail safe	Fail safe speed (high byte)	Fail safe speed (low byte)	
0x00	0x00	0x00	0x00	0x00	0x00	0x00	0x00	0x00	= 530 with 520R head

0x00	0x00	0x01	0xF4	0x00	0x00	0x00	0x00	0x00	= 530 with 520R head with minimum speed set and 50RPM
0x00	0x00	0x00	0x00	0x05	0xDC	0x00	0x00	0x00	= 530 with 520R head with maximum speed set at 150RPM
0x00	0x00	0x00	0x00	0x00	0x00	0x01	0x00	0x00	= 530 with 520R head with failsafe set at last demanded speed
0x00	0x00	0x00	0x00	0x00	0x00	0x02	0x02	0xEE	= 530 with 520R head with failsafe set at 12.8rpm

Pump type

Value	Pump
0x00	530 (DEFAULT)
0x01—	530
0x02—	630
0x03—	730

Pumphead type

Value	Pumphead
0x01—	Pre-assigned
0x—00	520R
0x—01	520R2
0x—02	520 Sanitary Tri-clamp elements (for 520REL, 520REM and 520REH pumpheads)
0x—03	520 Industrial quick release elements (for 520REL, 520REM and 520REH pumpheads)
0x—04	505L (continuous tube)
0x—05	313D
0x—06	313D2
0x—07	505L (double-Y element)
0x—09	505CA
0x—0A	314D
0x—0B	314D2

Note: Numerical values cannot include a decimal point. To enter a speed, move the decimal point one place to the right and enter an integer. To enter a tube size, move the decimal point two places to the right and enter an integer. See examples below:

Data examples

Speed (rpm)	Value
123.4	1234

Set min/max speeds

The min/max speed parameters are used to set the minimum and maximum speed from the PROFIBUS interface. The values are only used if the matching bit in the Control Word is enabled and they are not zero. All values are 16 bit unsigned in 1/10th of RPM of the head speed.

Fail-safe

The fail-safe user parameter is used to set the correct course of action to take in the event of a PROFIBUS communications failure. The fail-safe byte is configured as shown in the following table. If no bits are set or an invalid bit pattern is set the default fail safe behaviour shall be to stop the pump.

Bit	Description
0x00	No fail safe action
0x01	Last demanded speed
0x02	Fail-safe speed

The fail-safe speed parameter is used to set the speed at which the pump should be driven is a PROFIBUS communications error occurs and if bit 1 in the fail safe user parameter is set.

PROFIBUS data exchange

Default address:	126
PROFIBUS Ident:	0x0F70
GSD file:	WAMA0F70.GSD
Config:	0x62, 0x5D (3 words out, 14 words in)
User parameter bytes:	6

Cyclic data write (from master to pump)		
16 bit	Byte 1	Control word (high byte)
	Byte 2	Control word (low byte)
16 bit	Byte 3	Pumphead speed setpoint (unsigned) (high byte)
	Byte 4	Pumphead speed setpoint (unsigned) (low byte)
16 bit	Byte 5	Set flow calibration in μl per revolution (high byte)
	Byte 6	Set flow calibration in μl per revolution (low byte)

Control word	
Bit	Description
0	Motor running (1 = running)
1	Direction (0 = CW, 1 = CCW)
2	Tacho reset (1 = reset count)

Control word	
3	Reserved
4	Enable fieldbus min/max speeds (1 = enabled)
5	Enable fieldbus flow calibration (1 = enabled)
6	Ignore leak detection sensor
7	Fluid level reset
8	Head and tube
9-15	Reserved

Cyclic data read (from pump to master)		
16 bit	Byte 1	Status word (high byte)
	Byte 2	Status word (low byte)
16 bit	Byte 3	Pumphead speed setpoint (unsigned) (high byte)
	Byte 4	Pumphead speed setpoint (unsigned) (low byte)
16 bit	Byte 5	Hours run (high byte)
	Byte 6	Hours run (low byte)
32 bit	Byte 7	Tacho counter (high byte)
	Byte 8	Tacho counter (low byte)
	Byte 9	Tacho counter (high byte)
	Byte 10	Tacho counter (low byte)
16 bit	Byte 11	Pump outputs flow calibration in deci μl (For example: A value of 4 indicates 40 μl) (high byte)
	Byte 12	Pump outputs flow calibration in deci μl (For example: A value of 4 indicates 40 μl) (low byte)
32 bit	Byte 13	Fluid level (high byte)
	Byte 14	Fluid level (low byte)
	Byte 15	Fluid level (high byte)
	Byte 16	Fluid level (low byte)
32 bit	Byte 17, 18, 19, 20	Unassigned
32 bit	Byte 21, 22, 23, 24	Unassigned
32 bit	Byte 25, 26, 27, 28	Unassigned

*Note – ‘Pumphead speed setpoint (unsigned)’, reports the speed that the pump is running in Profibus mode.

This is reported as an integer in units of ‘rpm’ and will always be the same as the Profibus ‘pumphead speed setpoint’ received by the pump.

Customers who wish to verify the flow rate of the pump should use the tacho counter, (which reports pumphead revolutions where 10 increments = 1 revolution) and the µl per revolutions value (Byte 11,12) to calculate flow.

For example, first reset tacho counter to zero then record change in readings over 1 minute, then:

Flow µl/min = (pumphead revolutions in 1 min) x µl per rev

= (Change in tacho count in 1 min /10) x µl per rev

Status word	
Bit	Description
0	Motor running (1 = running)
1	Global error flag (1 = error)
2	Fieldbus control (1 = enabled)
3	Guard (Guard enabled models only) (1=guard open)
4	Over current error
5	Under voltage error
6	Over voltage error
7	Over temperature error
8	Motor stalled
9	Tacho fault
10	Leak detected
11	Low setpoint - out of range
12	High setpoint - out of range
13	Reserved
14	Reserved
15	Reserved

Device Related Diagnostic Data

	Byte 1, 2, 3, 4, 5, 6*	Mandatory Slave Bytes
8 bit	Byte 7	Header byte
8 bit	Byte 8	Pump model
8 bit	Byte 9	Pump head
8 bit	Byte 10	Tube size (high byte)
8 bit	Byte 11	Tube size (low byte)
8 bit	Byte 12	Min speed (high byte)
8 bit	Byte 13	Min speed (low byte)
8 bit	Byte 14	Max speed (high byte)
8 bit	Byte 15	Max speed (low byte)
32 bit	Byte 16, 17, 18, 19	Software version, Main CPU
32 bit	Byte 20, 21, 22, 23	Software version, HMI CPU
32 bit	Byte 24, 25, 26, 27	Software version, Flash
32 bit	Byte 28, 29, 30, 31	Software version, PROFIBUS CPU

***Note:** Bytes 1-6 may not be visible, depending on the Master system used.

Channel related diagnostic data

Byte 1	Header
Byte 2	Channel type
Byte 3	Channel related error code

Channel related diagnostic data	Byte 3
Global error	=0xA9 (General error)
Over current	=0xA1 (Short circuit)
Under voltage	=0xA2 (Under voltage)
Over voltage	=0xA3 (Over voltage)
Over temp	=0xA5 (Over temp)
Motor stall	=0xA4 (Overload)
Tacho fault	=0xB1 (Device related 0x11)
Leak detected	=0xB2 (Device related 0x12)
Setpoint out of range - low	=0xA8 (Lower limit exceeded)
Setpoint out of range - high	=0xA7 (Upper limit exceeded)
Fluid level alert	=0xB3 (Device related 0x15)

Note: Global error format: 8 bit header, 8 bit channel type and 8 bit error type

Operating this pump under PROFIBUS control is beyond the scope of this instruction manual. Consult your PROFIBUS network literature for further information.

Standard - 9 way D - PROFIBUS use

Interfacing the pump with the PROFIBUS network is by means of a 9 way D connector on the rear of the pump, (within the N module if the pump is N variant). Cable suitable for use in a PROFIBUS DP installation must be used.



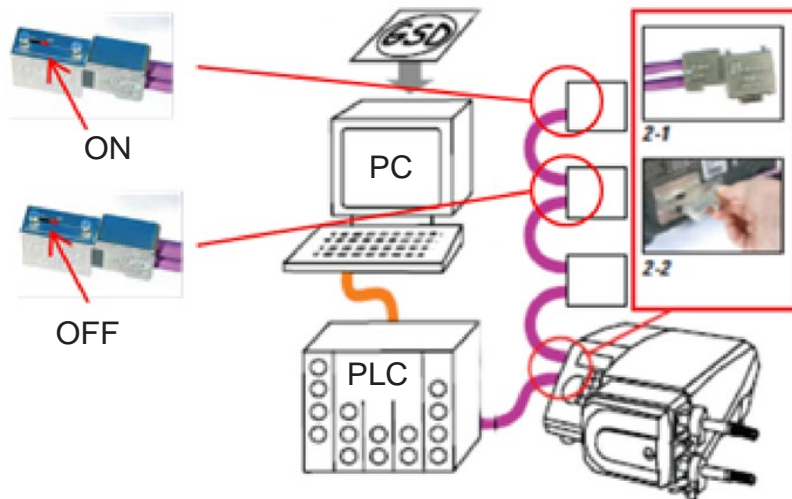

Avoid sharp bends in PROFIBUS communication cables.



Please follow PROFIBUS wiring standards.

14 Switching the pump on for the first time

Power up the pump. The pump displays the start-up screen with the Watson-Marlow Pumps logo for three seconds.



14.1 Selecting the display language

1. Use the \wedge/\vee keys to select your chosen language, and press **SELECT**.



2. Your selected language will now be displayed on screen. Choose **CONFIRM** to continue. All text will now appear in your chosen language.

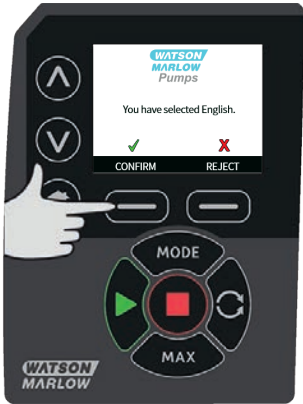

3. Choose **REJECT** to return to the language choice screen. This then proceeds to the home screen.



14.2 First-time start-up defaults

The pump is preset with operational parameters as shown in table below.

Parameter	530 default
Language	Not set
Default mode	Manual
Default manual speed	220rpm
Pump status	Stopped
Max speed	220rpm
Direction	CW
Pumphead	520R2
Tube size	9.6mm
Tube material	Bioprene
Flow calibration	15.12 ml/rev
Flow units	rpm
SG value	1
Keypad lock	Disabled
Auto-restart	OFF
Analog signal type	mA
Analog scaling type	mA
Analog min current	5mA
Analog max current	19mA
Analog min flow rate/rpm	0rpm
Analog max flow rate/rpm	220rpm
Beeper	ON
Security code	Not set
MemoDose flow rate	Mid flow rate of chosen pumphead
MemoDose volume	100ml
Pump number baud rate	9600
Stop bits	2
Profibus node address	126
Remote start/stop input	High = stop
Leak detector input	High = leak
Input 4	Disabled
Input 5	Disabled
Output 1	Run/stop
Output 1 - status	High = run

Parameter	530 default
Output 2	Direction
Output 2 - status	High = CW
Output 3	Auto/man
Output 3 - status	High = auto
Output 4	General alarm
Output 4 - status	High = alarm

The pump is now ready to operate according to the defaults listed above.

Note: The display background colour changes according to running state as follows:

- White background indicates pump stopped
- Grey background indicates pump running
- Red background indicates error or alarm

All operating parameters may be changed by means of key-presses (see section "Pump operation " on page 16).

If the Auto restart feature is enabled it may cause the pump to start as soon as power is turned on.

Auto-restart only affects operation of manual mode, network mode and memodose mode.



If Auto restart is enabled the "!" Symbol is shown on the screen to warn users that the pump may operate without any manual intervention (pump resumes with previous settings).

Do not use auto restart for more than 20 mains power starts per hour . We recommend remote control where a high number of starts is required.



If the pump is configured to network mode or analog mode it will respond to remote commands at any time including immediately after power on. The "!" Symbol is shown on the screen to warn users that the pump may operate without any manual intervention (e.g. a remote setpoint could start the pump with no key press required).

15 Switching the pump on in subsequent power cycles

Subsequent power-up sequences will jump from the start-up screen to the home screen.

- The pump runs a power-on test to confirm proper functioning of the memory and hardware. If a fault is found, an error code is displayed.
- The pump displays the start-up screen with the Watson-Marlow Pumps logo for three seconds followed by the home screen
- Start-up defaults are those in place when the pump was switched off last

Check that the pump is set to operate as you require it. The pump is now ready to operate.

All operating parameters may be changed by means of key-presses (see "Pump operation " on page 16).

Power interruption

This pump has an auto restart feature (which only affects manual mode, network mode and memodose operation) which, when active, will restore the pump to the operating state it was in when power was lost.

Stop/start power cycles

Do not power up/power down the pump more than 20 times in an hour, whether manually or by means of the auto-restart facility (which only affects manual mode, network mode and memodose operation). We recommend remote control where a high frequency of power cycles is required.

If the Auto restart feature is enabled it may cause the pump to start as soon as power is turned on.

Auto-restart only affects operation of manual mode, network mode and memodose mode.



If Auto restart is enabled the "!" Symbol is shown on the screen to warn users that the pump may operate without any manual intervention (pump resumes with previous settings).

Do not use auto restart for more than 20 mains power starts per hour . We recommend remote control where a high number of starts is required.



If the pump is configured to network mode or analog mode it will respond to remote commands at any time including immediately after power on. The "!" Symbol is shown on the screen to warn users that the pump may operate without any manual intervention (e.g. a remote setpoint could start the pump with no key press required).

16 Mode menu

Press **MODE** to display the Change mode menu.

Use the \wedge and \vee keys to scroll through the available modes.

- Manual(default)
- Flow calibration
- PROFIBUS
- CANCEL

Use **SELECT** to choose mode. Use the right hand function key to alter mode settings.



17 Manual

All settings and functions of the pump in manual mode are set and controlled by means of key-presses. Immediately after the start-up display sequence detailed in: "Switching the pump on in subsequent power cycles " on page 35, the manual mode home screen will be displayed unless auto restart is enabled.

Auto restart is a feature which only affects pump operation when the pump is set to manual mode, network mode and memodose mode. If Auto Restart is enabled and the pump is operating in any of these modes, the pump will return to the last known settings from that operating mode when the power is re-applied. When the pump is running it displays an animated clockwise arrow. In normal operation, the direction of flow is into the bottom port of the pumphead and out of the top port.

If an exclamation mark (!) is displayed, it indicates that the pump could automatically restart at any time. In manual mode network mode and memodose mode, the 'Auto restart' behaviour is configurable. If a padlock icon shows, it indicates that the keypad lock is on.

17.1 START



Starts the pump at the current flow displayed, and the display background changes to grey. If the pump is already running, pressing this has no effect.

17.2 STOP



Stops the pump. The display background changes to white. If the pump is not running pressing this has no effect.

17.3 INCREASING AND DECREASING FLOW RATE



Using the \wedge and \vee keys will increase or decrease the flow rate.

Decreasing flow rate

- A single key press will decrease flow rate by the least significant digit of the chosen flow rate unit.
- Repeat key presses as required to achieve the desired flow rate.
- Hold down the key for flow rate scrolling.

Increasing flow rate

- A single key press will increase flow rate by the least significant digit of the chosen flow rate unit.
- Repeat key presses as required to achieve the desired flow rate.
- Hold down the key for flow rate scrolling.

17.4 MAX FUNCTION (Manual mode only)



- Press and hold the **MAX** key to run at maximum flow.
- Release the key to stop the pump.
- The volume dispensed and time elapsed are displayed while the **MAX** key is pressed and held.

18 Flow calibration

This pump displays flow rate in ml/min.

18.1 Setting the flow calibration

Using the \wedge \vee keys, scroll to **Flow calibration** and press **CALIBRATE**.



Using the \wedge \vee keys, enter the maximum flow rate limit and press **ENTER**.



Press **START** to begin pumping a volume of fluid for calibration.



Press **STOP** to stop pumping fluid for the calibration.



Use the \wedge / \vee keys to enter the actual volume of fluid pumped.



To accept the new calibration press **ACCEPT** or **RE-CALIBRATE** to repeat the procedure. Press **HOME** or **MODE** to abort.



The pump is now calibrated.

19 PROFIBUS mode

19.1 MODE menu

Press **MODE** to display the Change mode menu.

Use the \wedge and \vee keys to scroll through the available modes:

- Manual (default)
- Flow calibration
- PROFIBUS
- CANCEL

Use **SELECT** to choose mode. Use the right hand function key to alter mode settings.



19.2 Manual mode operation when PROFIBUS is enabled

In Manual mode, if PROFIBUS is enabled, the P symbol will appear in the icon area. The P will be white if there is data exchange, it will be red if there is no data exchange. If there is no data exchange, the **INFO** button will become **BUS STATUS** in red.

Press **BUS STATUS** to get the PROFIBUS STATUS screen, the background will indicate pump status. It will not be red because this is not a critical error. The pump is still operating but is not reporting diagnostics to the master.



The MODE button gives access to the PROFIBUS settings and the station address. When the menus are accessed, the pump is technically still in MANUAL mode but with no PROFIBUS communications. After five minutes of inactivity the pump will revert back to the MANUAL home screen and discard any unsaved changes, if there are still no communications then the red P icon will be displayed. For further information on PROFIBUS communication errors see section "PROFIBUS communication errors" on page 48.



19.3 PROFIBUS mode

In this operating mode PROFIBUS control can be enabled or disabled. The pump is designed so that the station address can only be set from the pump. The user can set the station address within this mode.

Select **MODE**.

Use the \wedge and \vee keys to scroll to **PROFIBUS** and press **SELECT**.

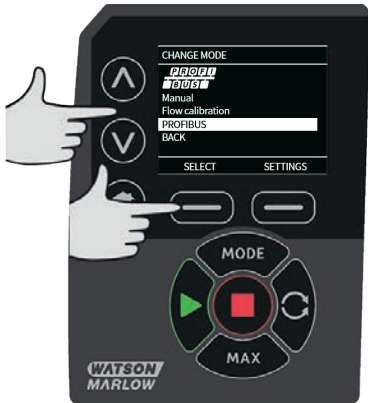

If PROFIBUS is not enabled, the screen below will prompt you to CONFIRM that you would like to enable PROFIBUS.



On the PROFIBUS home screen the white P icon indicates that there is data exchange.



Pressing the **INFO** function key will display further information.

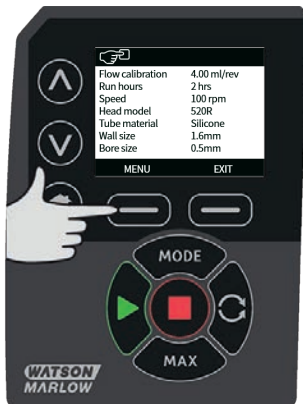

19.4 Assigning the PROFIBUS station address at the pump

The station address can only be set from PROFIBUS settings. The station address cannot be automatically assigned by the master.

Select **MODE**.

Use the \wedge and \vee keys to scroll to **PROFIBUS** and press **SETTINGS**.



Use the \wedge and \vee keys to alter the station address, in the range from 1 to 125 (126 is the default station address). Press **FINISH** to set the station address, or **NEXT** to enable/disable PROFIBUS communication.



Use the \wedge and \vee keys to enable or disable PROFIBUS communication and press **FINISH**.



19.5 PROFIBUS communication errors

In PROFIBUS mode, the screen below is displayed, the P indicates data exchange is happening.



This screen will only be displayed after successful implementation of Master Slave communications, which always follows the sequence shown in the diagram below.

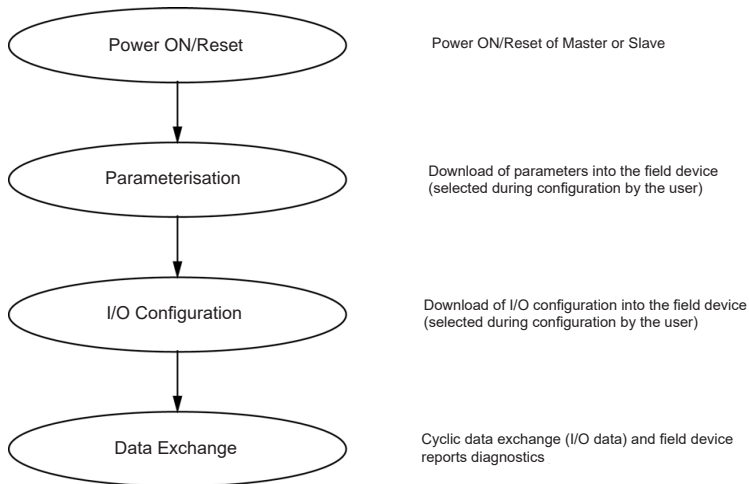

If data exchange is lost at any time, the following Bus Error screen will be displayed. The first red dot corresponds to the stage at which the error occurred and subsequent stages will indicate a red dot because the communication sequence halted before this point.



The screen will state 'Running' or 'Stopped', depending on how the user has set up the fail-safe function within the PROFIBUS GSD file (see below). The MODE button gives access to the PROFIBUS settings and the station address. When the menus are accessed, the pump is still in PROFIBUS bus mode but with no communications. After five minutes of inactivity the pump will revert back to the home screen and discard any unsaved changes, if there are still no communications then the BUS ERROR screen will be displayed.

19.6 PROFIBUS GSD file

The 530Bp, 530BpN, 630Bp, 630BpN and 730BpN pumps can be integrated into a PROFIBUS DP V0 network using a General Station Data (GSD) file. The file identifies the pump and contains key data including its communication settings, the commands it can receive and the diagnostic information it can pass to the PROFIBUS master on interrogation.

The GSD file — WAMA0F70.GSD — can be downloaded from the Watson-Marlow website and installed; or typed into a PROFIBUS master directly from this manual using a GSD editor program.

Note: The data-flow to and from the pump may need to be byte-reversed, due to differences of handling the data between suppliers of master devices.

```
;  
,*****  
,* ===== *  
,* *  
,* *  
,* Watson-Marlow Bredel Pumps *  
,* Bickland Water Road *  
,* Falmouth *  
,* Cornwall *  
,* TR11 4RU *  
,* Tel.: +44(1326)370370 *  
,* FAX.: +44(1326)376009 *  
,* *  
,* *  
,* ===== *  
,* Filename: WAMA0F70.GSD *  
,* GSD file version 3 from 2013-09-24 *  
,* ----- *  
,* *  
,* *  
,*****  
#Profibus_DP  
GSD_Revision = 3  
Vendor_Name = "Watson Marlow"  
Model_Name = "530/630/730 Profibus Pumps"  
Revision = "Version 1.00"  
Ident_Number = 0x0F70  
Protocol_Ident = 0  
Station_Type = 0
```

FMS_supp = 0
Hardware_Release = "V1.00"
Software_Release = "V1.00"
Redundancy = 0
Repeater_Ctrl_Sig = 0
24V_Pins = 0
9.6_supp = 1
19.2_supp = 1
45.45_supp = 1
93.75_supp = 1
187.5_supp = 1
500_supp = 1
1.5M_supp = 1
3M_supp = 1
6M_supp = 1
12M_supp = 1
MaxTsdrr_9.6=60
MaxTsdrr_19.2=60
MaxTsdrr_45.45=60
MaxTsdrr_93.75=60
MaxTsdrr_187.5=60
MaxTsdrr_500=100
MaxTsdrr_1.5M=150
MaxTsdrr_3M=250
MaxTsdrr_6M=450
MaxTsdrr_12M=800
Slave_Family = 0
Implementation_Type = "VPC3+S"
Info_Text="PROFICHIP: PROFIBUS DPV0 - slave, Watson Marlow 530/630/730 Profibus Pumps"
Freeze_Mode_supp=1
Sync_Mode_supp=1
Fail_Safe=1
Auto_Baud_supp=1

```
Set_Slave_Add_supp=0
Min_Slave_Intervall=6
Modular_Station=0
Max_Diag_Data_Len=34
Max_User_Prm_Data_Len = 9
Ext_User_Prm_Data_Const(0)= 0x00,0x00,0x00,0x00,0x00,0x00,0x00,0x00,0x00
Module="WM Pump, 3/14 word out/in" 0x62,0x5D
1
EndModule
```

20 Main menu

To access the main menu press the **MENU** button from one of the HOME screens or INFO screens.



This will display the main menu as shown below. Use the \wedge / \vee keys to move the selection bar between the available options.

Press **SELECT** to choose an option.

Press **EXIT** to return to the screen from where the MENU was called.



20.1 Security settings

Security settings can be changed by selecting **SECURITY SETTINGS** from the Main menu.

Auto keypad lock

Press **ENABLE/DISABLE** to switch on/off the Auto keypad lock. When active the keypad will 'lock' after 20 seconds of inactivity.



Once locked it will display the screen below when any key is pressed. To unlock the keypad press the two **UNLOCK** keys together.

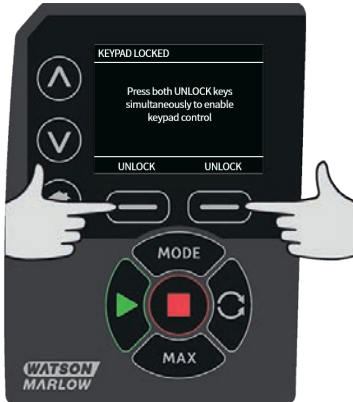

The padlock icon will appear on the operating mode home screen to show that keypad lock is activated.



Note that the STOP key will always work whether the keypad is locked or not.

PIN protection

Using the \wedge / \vee keys select **PIN protection** from the SECURITY SETTINGS menu and press **ENABLE/DISABLE** to switch on/off the PIN protection. If PIN protection has been enabled, a Master level PIN will be required to disable PIN lock.

Setting Master PIN

Setting the Master PIN protects all functionality. The Master is able to selectively enable functionality for two additional operators. These are defined as User 1 and User 2. They will be able to access this functionality by entering a PIN code assigned to them by the Master user. To set the Master PIN, scroll to Master level and press **ENABLE**.



To define a four digit Master PIN, use the \wedge / \vee keys to select each digit from 0-9. Once you have the required digit press the **NEXT DIGIT** key. After selecting the fourth digit press **ENTER**.



Now press **CONFIRM** to check that the number entered is the PIN you require. Press **CHANGE** to return to PIN entry.



The following screen will be displayed to indicate that the Master PIN has been applied to access all functionality. Press **NEXT** to selectively enable functionality access for User 1 and User 2.



Configure User 1 security settings

The PIN PROTECTION level screen will be displayed with User 1 highlighted, press **ENABLE** to configure User 1 security settings or scroll to configure an alternative User.



ENABLE user 1 security settings displays the PIN entry screen for User 1. To define a four digit User 1 PIN, use the \wedge / \vee keys to select each digit from 0-9. Once you have the required digit press the **NEXT DIGIT** key. After selecting the fourth digit press **ENTER**.



Now press **CONFIRM** to verify that the number entered is the PIN you require. Press **CHANGE** to return to PIN entry.

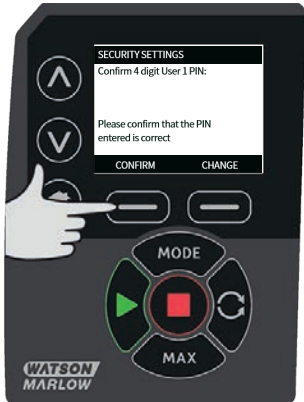

To define the allowed functionality, use the \wedge / \vee keys to select the functionality and press **ENABLE**. User 1 PIN will allow access to only the enabled functionality, to disable functionality, highlight the enabled functionality and press **DISABLE**. When all the required functionality has been enabled, press **FINISH**.



Configure User 2 security settings

The PIN PROTECTION level screen will be displayed with User 2 highlighted, press **ENABLE** to configure User 2 security settings or scroll to configure an alternative User.



ENABLE user 2 security settings displays the PIN entry screen for User 2. To define a four digit User 2 PIN, use the \wedge / \vee keys to select each digit from 0-9. Once you have the required digit press the **NEXT DIGIT** key. After selecting the fourth digit press **ENTER**.



To define the allowed functionality, use the \wedge / \vee keys to select the functionality and press **ENABLE**. User 2 PIN will allow access to only the enabled functionality, to disable functionality, highlight the enabled functionality and press **DISABLE**. When all the required functionality has been enabled, press **FINISH**.

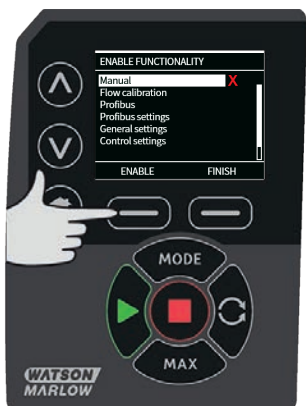

Note: Once Security Settings for User 1 and User 2 have been set by the Master, only the Master PIN will allow access to Security Settings.

The HOME screen will be displayed. A PIN is now required to access all functionality. The Master PIN accesses all pump functionality and the User 1 and User 2 PINs access only the defined functionality. To enter the PIN, use the ^ /v keys to select each digit from 0-9. Once you have the required digit press the **NEXT DIGIT** key. After selecting the fourth digit press **ENTER**.

If an incorrect PIN has been entered the following screen will be displayed. NOTE: this screen will also display if the PIN entered does not allow access to that functionality.



If a PIN number is entered that is already in use, the following screen will be displayed, press **CHANGE** to input an alternative PIN or **EXIT** to abort



If the PIN entered does not allow access to the functionality the following screen will be displayed.



Keypad beep

From SECURITY settings scroll to Keypad beep using the \wedge / \vee keys and select **ENABLE**. The pump will now beep at every key press.



PIN entry on start-up

The setting **PIN entry during start-up** can be used to configure the software to choose if PIN entry is required during start up.

This feature also means that auto-restart capability is now independent of PIN code entry after start up.

If this setting is enabled ✓ then the pump will require the PIN code to be entered before the pump will enter the home control screen after a power cycle.

If this setting is disabled ✕ then the pump will not require the PIN code to be entered before the pump will enter the home control screen after a power cycle.

The auto-restart response of the pump after a power cycle is now independent of PIN entry.

The default setting, is enabled ✓ so a PIN code will be required after a power cycle before the pump will enter the home control screen.

Disabling this feature does not change any other aspects of PIN code operation. Anyone wishing to modify pump settings will still need to enter the PIN code.

20.2 General settings

To view the general settings menu, select **GENERAL SETTINGS** from the main menu.

Auto restart

This pump includes a feature called auto restart. This setting only applies to pump operation in manual mode, network mode and memodose mode.

If the pump is operating in any of these modes and this feature is enabled (configured to 'yes'), it will change the way the pump responds to a power cycle.

When Auto restart is enabled it will cause the pump to remember it's current operating settings when power is lost and to resume using these as soon as power comes back on.

This parameter only affects manual mode, network mode and memodose mode operation.

The '!' symbol is also displayed when the auto restart feature is enabled to warn users that the pump has been configured in a way that could result in unexpected operation.

Press **ENABLE/DISABLE** to turn the auto restart feature on/off (Manual mode, network mode and memodose feature only).



Do not use auto restart for more than 20 mains power starts per hour. We recommend remote control where a high number of starts is required.

If the Auto restart feature is enabled it may cause the pump to start as soon as power is turned on.

Auto-restart only affects operation of manual mode, network mode and memodose mode.



If Auto restart is enabled the "!" Symbol is shown on the screen to warn users that the pump may operate without any manual intervention (pump resumes with previous settings).

Do not use auto restart for more than 20 mains power starts per hour . We recommend remote control where a high number of starts is required.



If the pump is configured to network mode or analog mode it will respond to remote commands at any time including immediately after power on. The "!" Symbol is shown on the screen to warn users that the pump may operate without any manual intervention (e.g. a remote setpoint could start the pump with no key press required).

The ! symbol is a warning that the pump could remotely activate at any time. It will always be displayed when the pump is in any remote control mode (analog and network mode). It will also be displayed when auto restart has been enabled as the pump could activate after a power cycle, (auto-restart applies to manual mode, network mode and memodose).



Flow units

The current chosen flow unit is displayed on the right hand side of the screen. To change flow units move the selection bar over the flow unit menu entry and press **SELECT**.

Use the ^ /v keys to move the selection bar over the required flow unit, then press **SELECT**. All flow rates displayed on screens will now be in the chosen units.



If a mass flow unit is selected, the specific gravity of the fluid must be entered. The following screen is displayed.



Use the \wedge \vee keys to enter the value of the specific gravity, and press **SELECT**.

Pump label

The pump label is a user defined 20 digit alphanumeric label which is displayed in the header bar of the home screen. To define or edit the pump label, move the selection bar over the Pump label menu entry and press **SELECT**. If a pump label has been previously defined, this will be displayed on screen to allow editing, otherwise it will display the default label "WATSON-MARLOW".



Use the \wedge / \vee keys to scroll through the available characters for each digit. The available characters are 0-9, A-Z and SPACE.

Press **NEXT** to move onto the next character, or **PREVIOUS** to move back to the previous character.



Press **FINISH** to save the entry and return to the general settings menu.



Pumphead type

Select GENERAL SETTINGS from the main menu.

Use the \wedge / \vee keys to move the selection bar over **Pumphead type** and press **SELECT**. The following screen will be displayed.



Use the \wedge / \vee keys to move the selection bar over **Pumphead** and press **SELECT**.



Use the \wedge / \vee keys to move the selection bar over the required pumphead type and press **SELECT**.



Tube size and tube material

Select **Tube size** from GENERAL SETTINGS, then use the \wedge / \vee keys to move the selection bar over **Bore size** and press **SELECT**.



Use the \wedge / \vee keys to move the selection bar over the tube size to be used and press **SELECT**.

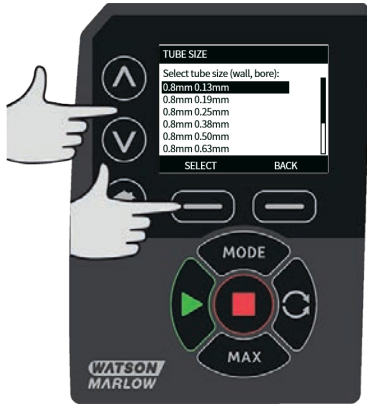

If a LoadSure element has been selected then the tube size is displayed as pressure and bore.



This screen also allows you to select the tube material used.

Use the \wedge / \vee keys to move the selection bar over **Tube material** and press **SELECT**.



Use the \wedge / \vee keys to move the selection bar over the tube material to be used and press **SELECT**.



The PUMPHEAD MODEL screen allows the tube Lot Number to be recorded for future reference. Use the \wedge \vee keys to move the selection bar over **Tube lot number** and press **SELECT**.

Use the \wedge \vee keys to scroll through the available characters for each digit. The available characters are 0-9, A-Z, and SPACE.

Press **NEXT** to move onto the next character, or **PREVIOUS** to move back to the last character.



Press **FINISH** to save the entry and return to the general settings menu.

Restore defaults

To restore the factory default settings select **Restore defaults** from the general settings menu.

There are two confirmation screens to ensure that this function is not carried out in error.

Press **CONFIRM** followed by **RE-CONFIRM** to restore the defaults.

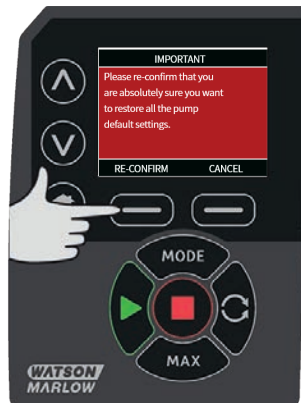
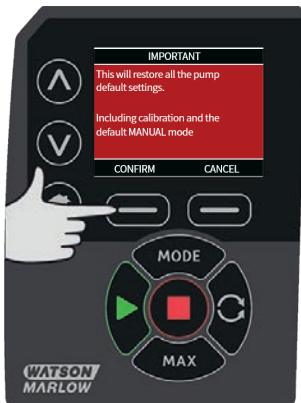

Language

Select language from the general settings menu to choose an alternative display language for the pump. The pump must be stopped before changing the language.

Use the \wedge / \vee keys to move the selection bar to your required language. Press **SELECT** to confirm.



Your selected language will now be displayed on screen. Press **CONFIRM** to continue, all displayed text will now appear in your chosen language.

Press **REJECT** to return to the language choice screen.



MODE menu

Selecting **MODE** menu from the main menu will navigate you to access the sub-menu shown below. This is the same as pressing the **MODE** key. Please see "Mode menu" on page 1 for further details.

Reset run hours

Select **Reset run hours** from the control settings menu.

Select **RESET** to zero the run hours counter. The run hours counter can be viewed by pressing **INFO** from your home screen. The following screen will be displayed. Press **RESET** to reset the run hours or **CANCEL** to return to the CONTROL SETTINGS menu.



21 Help

21.1 Help

Select Help from the main menu to access the help screens.



SOFTWARE VERSIONS	BOOTLOADER VERSIONS
Main Processor Code: 1.2	Main Processor Code: 1.2
HMI Processor Code: 1.2	HMI Processor Code: 1.2
HMI Screen Resources: 1.2	
PROGRAM JS Processor Code: 1.2	
BOOTLOADER BACK	BACK

22 Troubleshooting

If the pump display remains blank when the pump is switched on, make the following checks:

- Check that the mains power is available to the pump.
- Check the fuse in the wall plug if one is present.
- Check the position of the voltage selector switch.
- Check the mains power switch at the rear of the pump.
- Check the fuse in the fuse holder in the centre of the switch plate at the rear of the pump.

If the pump runs but there is little or no flow, make the following checks:

- Check that fluid is supplied to the pump.
- Check for any kinks or blockages in the lines.
- Check that any valves in the line are open.
- Check that the tube and rotor are in the pumphead.
- Check that the tube is not split or burst.
- Check that the correct wall-thickness tube is being used.
- Check the direction of rotation.
- Check that the rotor is not slipping on the drive shaft.

If the pump turns on, but will not run:

- Check the remote stop function and configuration.
- Check the mode you are in, are you in analog mode.
- Try to operate and run the pump in manual mode.

If the pump is not controllable under PROFIBUS, make the following checks:

- Check that PROFIBUS wiring has been installed correctly.
- Check that the pump's PROFIBUS address has been set and that PROFIBUS is enabled.
- Check that the pump has been switched to PROFIBUS control using the MODE menu or key.
- Check that the pump is not displaying an error message.
- Check that the PROFIBUS master has not diagnosed a problem with the pump or its connection.

22.1 Leak detection

If a Watson-Marlow leak detector has been fitted to the pumphead, and a leak is detected; the pump will display the following message:



Follow the instructions in "Tube replacement " on page 82 to replace your tube or tubing element.

If this message is repeated when power is returned to the pump check that the leak detector is clean and free of debris and cycle the power to the pump.

Note: The message will continue to be displayed unless the leak is cleared and the acknowledge key is pressed.

22.2 Error codes

If an internal error occurs, an error screen with a red background is displayed. Note: Signal out of range, over signal and leak detected error screens report the nature of an external condition. They do not flash.

Error code	Error condition	Suggested action
Er 0	FRAM write error	Attempt to reset by switching power OFF/ON. Or seek support.
Er 1	FRAM corruption	Attempt to reset by switching power OFF/ON. Or seek support.
Er 2	FLASH write error during drive update	Attempt to reset by switching power OFF/ON. Or seek support.
Er 3	FLASH corruption	Attempt to reset by switching power OFF/ON. Or seek support.
Er 4	FRAM shadow error	Attempt to reset by switching power OFF/ON. Or seek support.
Er 9	Motor stalled	Stop pump immediately. Check pumphead and tube. Power OFF/ON may reset. Or seek support.
Er10	Tacho fault	Stop pump immediately. Power OFF/ON may reset. Or seek support.

Error code	Error condition	Suggested action
Er14	Speed error	Stop pump immediately. Power OFF/ON may reset. Or seek support.
Er15	Over current	Stop pump immediately. Power OFF/ON may reset. Or seek support.
Er16	Over voltage	Stop pump immediately. Check supply. Power OFF/ON may reset.
Er17	Under voltage	Stop pump immediately. Check supply. Power OFF/ON may reset.
Er20	Signal out of range	Check analog control signal range. Trim signal as required. Or seek support.
Er21	Over signal	Reduce the analog control signal.
Err50	Communication error (internal pump communications error and not a network error)	Attempt to reset by switching power OFF/ON. Or seek support.

22.3 Technical support

Watson-Marlow Fluid Technology Group
Falmouth, Cornwall
TR11 4RU
UK

Contact your local Watson-Marlow representative for support.
www.wmftg.com/contact

23 Drive maintenance

There are no user serviceable parts inside the pump. Please contact your local Watson-Marlow representative to arrange repair.

24 Drive spares

Description	Part No.
Replaceable main fuse, type T2, 2.5A H 250V 20mm (Pack of 5)	MNA2107A
Foot (Pack of 5)	MNA2101A
Module seal	MN2516B
Module switch cover	MN2505M
Glands (STD)	GR0056
Glands (EMC)	GR0075
Blanking plugs	GR0057
Sealing washer for blanking plug and gland	GR0058
Snap-fit vent	MN2513B

25 Pumphead replacement



Always isolate the pump from the mains power supply before opening any guard or track, or performing any positioning, removal or maintenance operation.

25.1 Pumphead replacement

520R

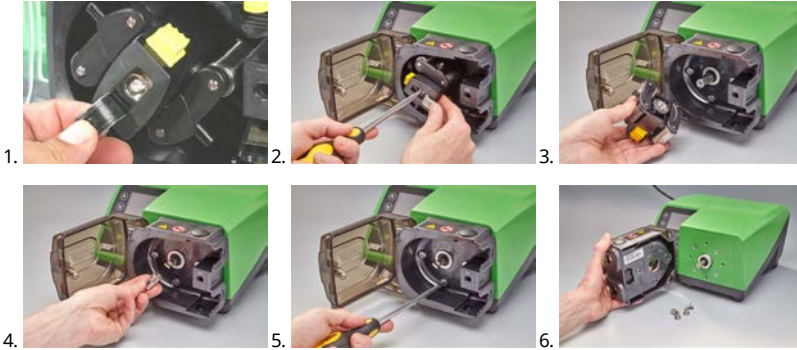

26 Tube replacement



Always isolate the pump from the mains power supply before opening any guard or track, or performing any positioning, removal or maintenance operation.

26.1 Continuous tubing

520R and 520R2

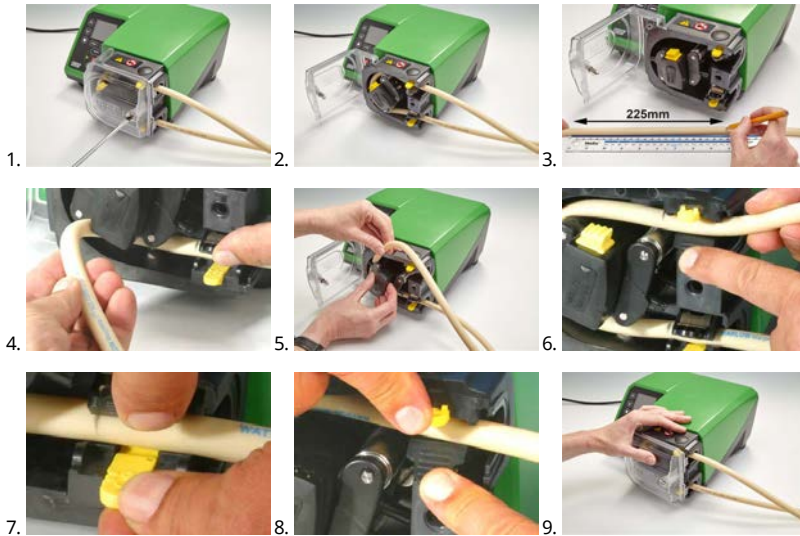

505L

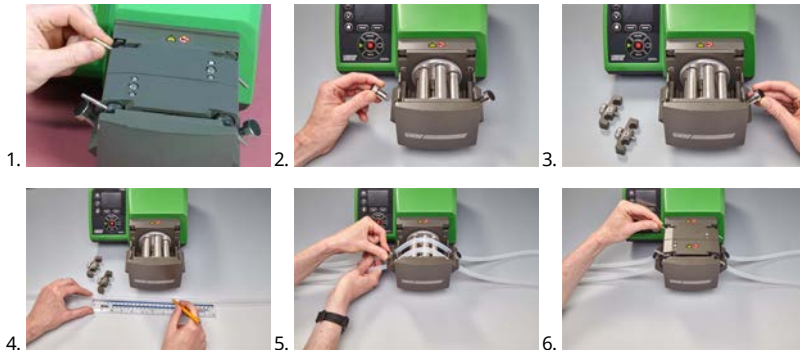

$\leq 8.0\text{mm} = 145\text{mm}$,

$9.6\text{mm} = 150\text{mm}$

26.2 Tube elements

Grey	Beige	Blue
>2 bar (30psi)	>4 bar (60psi)	>7 bar (100psi)
		

520REL, 520REM and 520REH

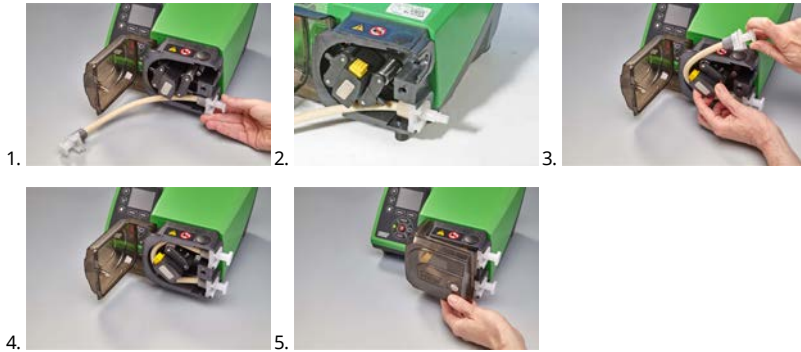

530 Sanitary connectors



530 Industrial connectors



505L



General guide to cleaning with solvents

Chemical	Cleaning precautions
Aliphatic hydrocarbons	Remove guard. Minimize rotor cap and clutch boot exposure to less than one minute (risk of attack).
Aromatic hydrocarbons	Remove guard. Minimize rotor cap and clutch boot exposure to less than one minute (risk of attack).
Ketone solvents	Remove guard. Minimize rotor cap and clutch boot exposure to less than one minute (risk of attack).
Halogenated/chlorinated solvents	Not recommended: possible risk to polycarbonate tube clamp adjusters and polypropylene tube clamp locators.
Alcohols, general	No precaution necessary.
Glycols	Minimize rotor cap and clutch boot exposure to less than one minute (risk of attack).
Estersolvents	Remove guard. Minimize rotor cap and tube clamp location cap exposure to less than one minute (risk of attack).
Ether solvents	Not recommended: possible risk to polycarbonate tube clamp adjusters and polypropylene tube clamp locators.

27 Ordering information

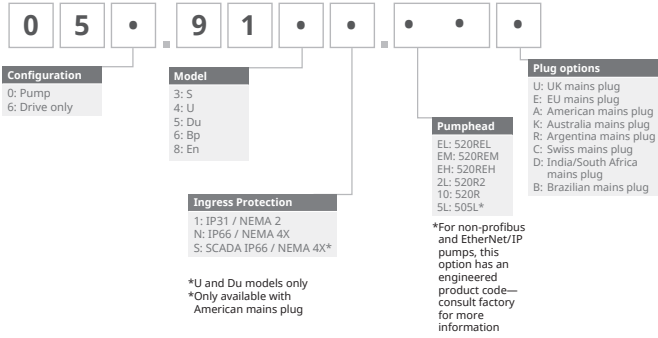

27.1 Pump part numbers





*Special NEMA module 059.911.F.100 Ethernet Watertight Module (530F) IP66 NEMA 4X is required for KROHNE flow sensor, combined with IP31 pump

27.2 Tubing and element part numbers



1.6mm wall tubing for 520R pumpheads

					
mm	inch	#	Marprene	Bioprene	STA-PURE Series PFL
0.5	1/50	112	902.0005.016	933.0005.016	—
0.8	1/32	13	902.0008.016	933.0008.016	—
1.6	1/16	14	902.0016.016	933.0016.016	966.0016.016
3.2	1/8	16	902.0032.016	933.0032.016	966.0032.016
4.8	3/16	25	902.0048.016	933.0048.016	966.0048.016
6.4	1/4	17	902.0064.016	933.0064.016	966.0064.016
8.0	5/16	18	902.0080.016	933.0080.016	966.0080.016
mm	inch	#	STA-PURE Series PCS	Neoprene	
0.8	1/32	13	—	920.0008.016	
1.6	1/16	14	—	920.0016.016	
3.2	1/8	16	961.0016.016	920.0032.016	
4.8	3/16	25	961.0032.016	920.0048.016	
6.4	1/4	17	961.0048.016	920.0064.016	
8.0	5/16	18	961.0064.016	920.0080.016	
mm	inch	#	Pumpsil		
0.5	1/50	112	913.A005.016		
0.8	1/32	13	913.A008.016		
1.6	1/16	14	913.A016.016		
3.2	1/8	16	913.A032.016		
4.8	3/16	25	913.A048.016		

					
6.4	1/4	17	913.A064.016		
8.0	5/16	18	913.A080.016		

Note: 1.6mm wall STA-PURE Series PFL and STA-PURE Series PCS tubing are supplied in 305mm lengths.

2.4mm wall tubing for 520R2 pumpheads

					
mm	inch	#	Marprene	Bioprene	Pumpsil
0.5	1/50	—	—	—	913.A005.024
0.8	1/32	—	—	—	913.A008.024
1.6	1/16	119	902.0016.024	933.0016.024	913.A016.024
3.2	1/8	120	902.0032.024	933.0032.024	913.A032.024
4.8	3/16	15	902.0048.024	933.0048.024	913.A048.024
6.4	1/4	24	902.0064.024	933.0064.024	913.A064.024
8.0	5/16	121	902.0080.024	933.0080.024	913.A080.024
9.6	3/8	122	902.0096.024	933.0096.024	913.A096.024
mm	inch	#	STA-PURE Series PFL	STA-PURE Series PCS	
0.8	1/32	—	—	—	
1.6	1/16	119	966.0016.024	961.0016.024	
3.2	1/8	120	966.0032.024	961.0032.024	
4.8	3/16	15	966.0048.024	961.0048.024	
6.4	1/4	24	966.0064.024	961.0064.024	
8.0	5/16	121	966.0080.024	961.0080.024	

Note: 2.4mm wall STA-PURE Series PFL and STA-PURE Series PCS tubing are supplied in 355mm lengths.

2.4mm wall elements for 520RE pumpheads

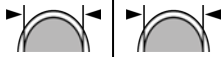
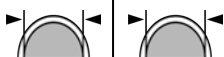
0-2 bar (0-30 psi) pressure rated elements						
						
Industrial						
mm	inch	#	Marpene TL	Pumpsil	Neoprene	
3.2	1/8	16	902.0032.PFQ	913.A032.PFQ	920.0032.PFQ	
6.4	1/4	17	902.0064.PFQ	913.A064.PFQ	920.0064.PFQ	
9.6	3/8	122	902.0096.PFQ	913.A096.PFQ	920.0096.PFQ	
Sanitary						
mm	inch	#	Bioprene TL	Pumpsil	STA-PURE Series PCS	STA-PURE Series PFL
3.2	1/8	16	933.0032.PFT	913.A032.PFT	961.0032.PFT	966.0032.PFT
6.4	1/4	17	933.0064.PFT	913.A064.PFT	961.0064.PFT	966.0064.PFT
9.6	3/8	122	933.0096.PFT	913.A096.PFT	961.0096.PFT	966.0096.PFT
2-4 bar (30-60 psi) pressure rated elements						
						
Industrial						
mm	inch	#	Marpene TM			
3.2	1/8	16	902.P032.PFQ			
6.4	1/4	17	902.P064.PFQ			
Sanitary						
mm	inch	#	Bioprene TM		STA-PURE Series PCS	
3.2	1/8	16	933.P032.PFT		961.M032.PFT	
6.4	1/4	17	933.P064.PFT		961.M064.PFT	

4-7 bar (60-100 psi) pressure rated elements

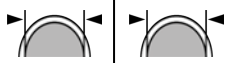

Industrial

mm	inch	#	Marprene TH
3.2	1/8	16	902.H032.PFQ

Sanitary

mm	inch	#	Bioprene TH	STA-PURE Series PCS
3.2	1/8	16	933.H032.PFT	961.H032.PFT

27.3 Pumphead spares

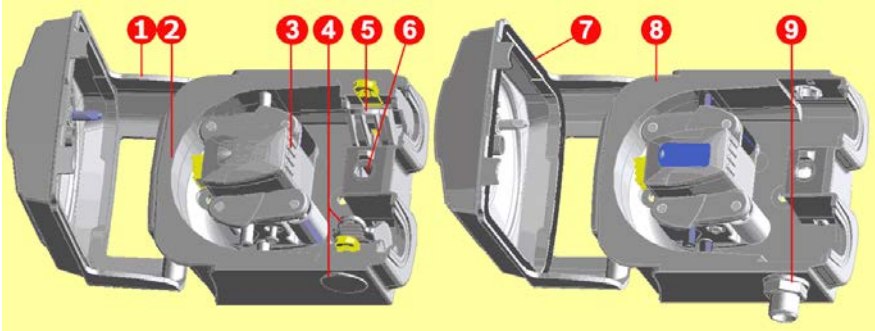

520R/520R2		520REL/520REM/520REH
Assembly number	Part Number	Description
	053.1011.100	520R
	053.1011.2L0	520R2
	053.1011.EL0	520REL
	053.1011.EM0	520REM
	053.1011.EH0	520REH
1	MNA2050A (520R, 520R2)	Pumphead guard complete with tool-unlockable latch
2	MNA2045A (520R, 520R2)	Track assembly for cased pumps complete with spring-loaded tube clamps
3	MNA2043A (520R - 1.6mm wall tube)	Rotor assembly complete with pumping rollers, follower rollers and tube guide rollers
	MNA2001 (520R2 - 2.4mm wall tube)	
	MNA2138A (grey) (520REL)	
	MNA2139A (beige) (520REM)	
	MNA2140A (blue) (520REH)	

Assembly number	Part Number	Description
4	MNA2006A (520R, 520R2)	Bottom (LH) tube clamp Tube clamp location plug Drain plug
	MN2002M (520R, 520R2)	
	MN2131M (520RE)	
5	MNA2005A (520R, 520R2)	Top (RH) tube clamp
	MN2002M (520R, 520R2)	Tube clamp location plug
6	MN2034B	Guard latch spring
	MN2005M	Guard latch spring cartridge
7	MNA2147A (520RE)	Pumphead guard complete with seal and tool-lockable latch
8	MNA2144A (520RE)	Track assembly for cased pumps
9	MN2023T and MN2003T (520RE)	Drain port and nut

27.4 Pumping accessories

Accessory	Description	Part code	Pump compatibility
520ANC	Network cable, RS232, with 9-pin D-connectors	059.3121.000	530Du, 530Di
520ANX	Network extension cable with 9-pin D-connectors	059.3122.000	530Du, 530Di
520ANA	Network adaptor, 25-pin to 9-pin D-connectors	059.3123.000	
520AB	Batch records cable with 9-pin D-connectors	059.3125.000	530Di
520AF	Foot switch with 25-pin D-connector	059.3002.000	530U, 530Du, 530Di
520AH	Hand switch with 25-pin D-connector	059.3022.000	530U, 530Du, 530Di
505LTC	Tube clamp set for 505L pumphead	059.4001.000	530Di

Accessory	Description	Part code	Pump compatibility
505AS	Filling stand	059.5001.000	All models
520AL	Dispensing lance for use with 520AFN filling needles	059.5052.000	All models
505AFN	Filling needle set	059.5101.000	All models
	Filling needle 1.6mm bore	059.5100.016	All models
	Filling needle 3.2mm bore	059.5100.032	All models
	Filling needle 4.8mm bore	059.5100.048	All models
	Filling needle 6.4mm bore	059.5100.064	All models
	Filling needle 8.0mm bore	059.5100.080	All models
520AD	Leak detector kit	059.8121.000	530U, 530Du, 530Di
520AD	Leak detector kit	059.8131.000	530UN, 530DuN, 530DiN

28 Performance data

28.1 Performance curves

Flow rates of suction and discharge pressures for the pumphead at different drive speeds.

This data was produced pumping water at ambient temperature.

Marpene continuous tubing, 1.6mm wall, 200rpm, clockwise rotation

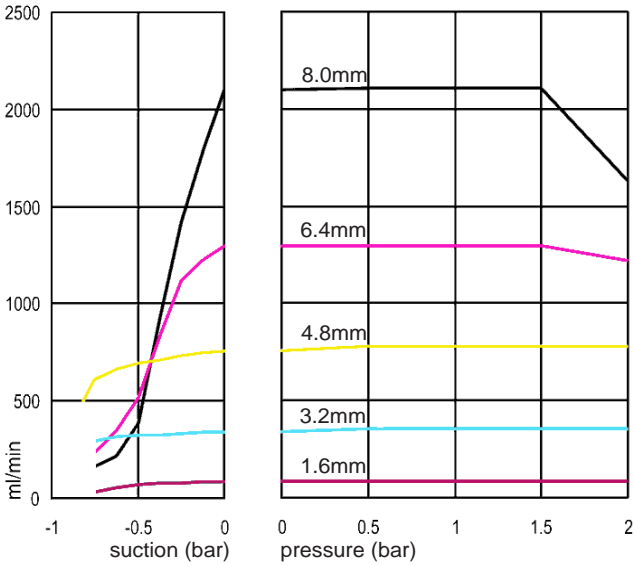

Marprene continuous tubing, 1.6mm wall, 200rpm, counter-clockwise rotation

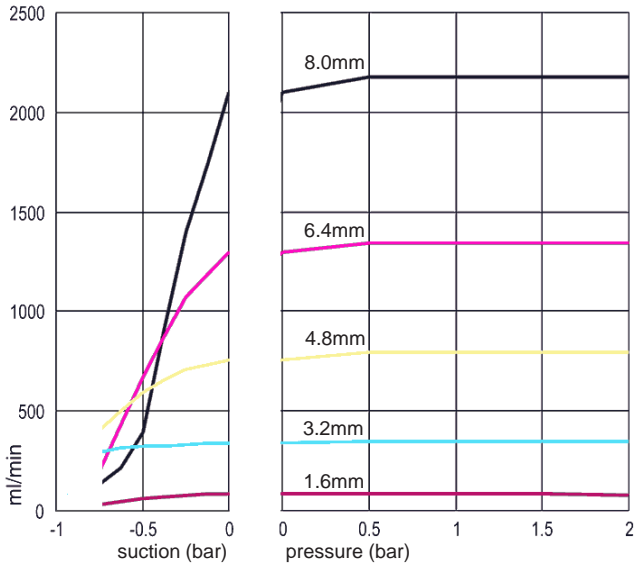

Marprene continuous tubing, 2.4mm wall, 200rpm, clockwise rotation

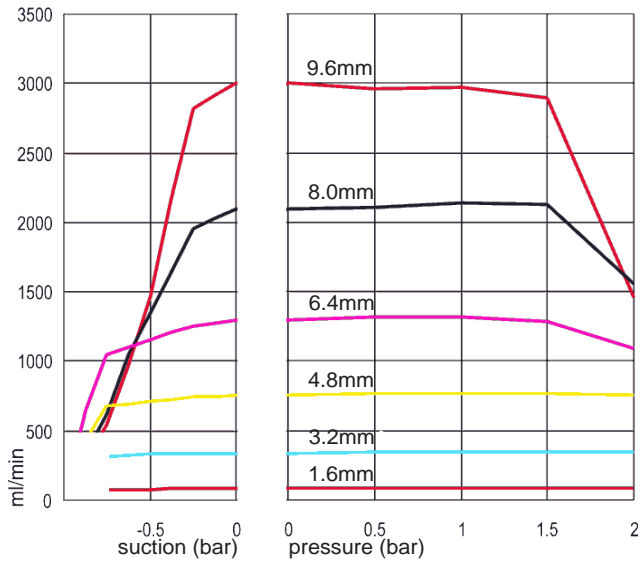

Marpene continuous tubing, 2.4mm wall, 200rpm, counter-clockwise rotation

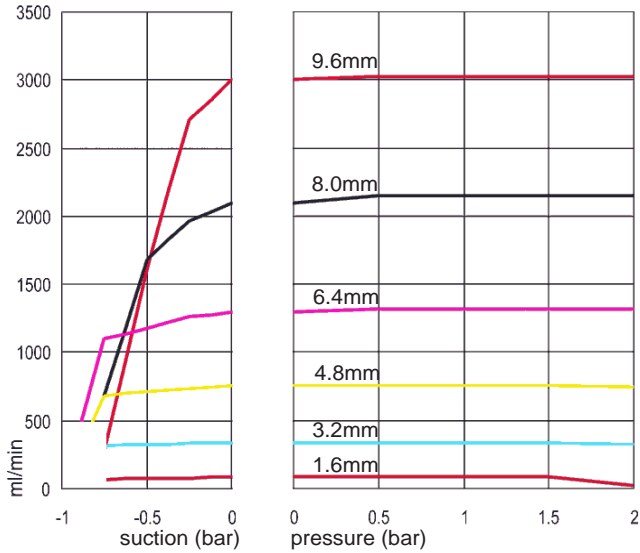

Marpene TL element, 0-2 bar (0-30psi), 200rpm, counter-clockwise rotation

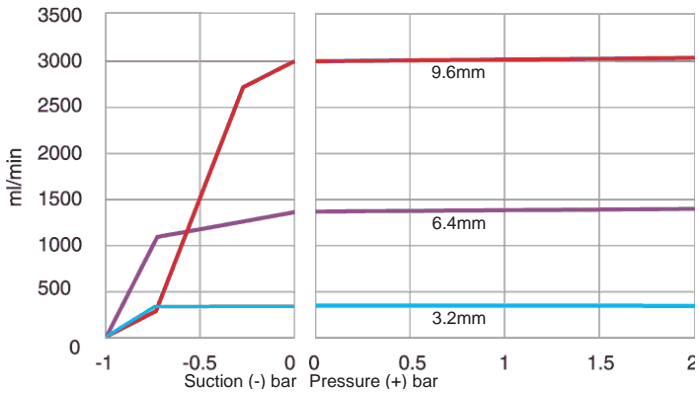

Sta-Pure element, 0-2 bar (0-30psi), 200rpm, counter-clockwise rotation

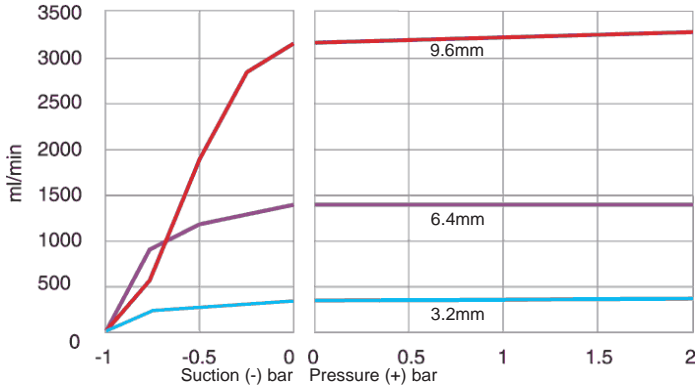

Marprene TM element, 2-4 bar (20-60psi), 200rpm, counter-clockwise rotation

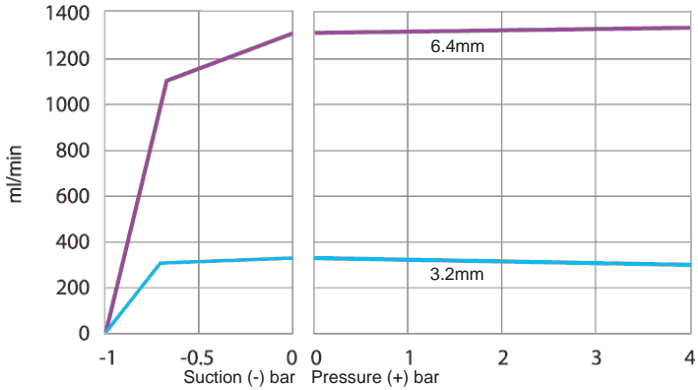

Sta-Pure element, 2-4 bar (30-60psi), 200rpm, counter-clockwise rotation

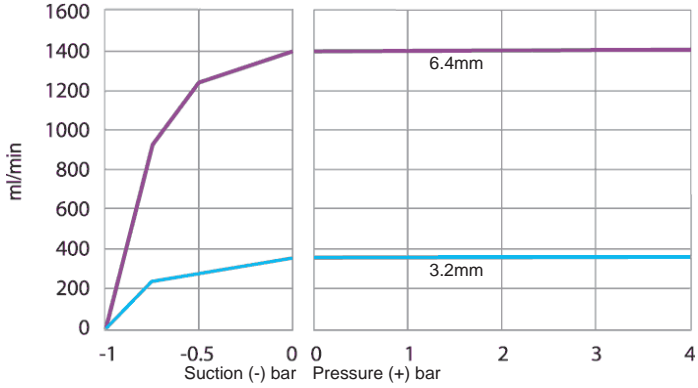

Marprene TH element, 4-7 bar(60-100psi), 200rpm, counter-clockwise rotation

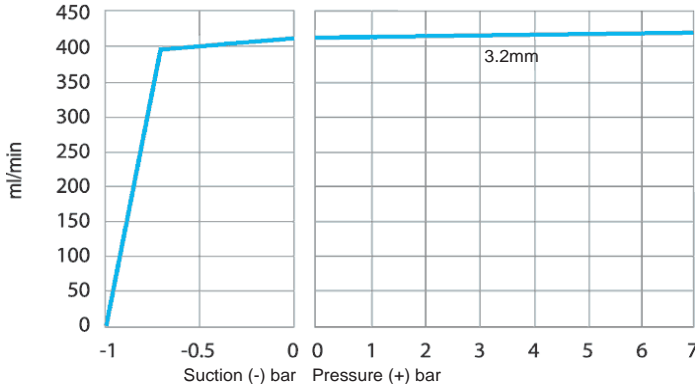

Maxthane LoadSure Elements, Counter clockwise Rotation 200rpm RET rotor

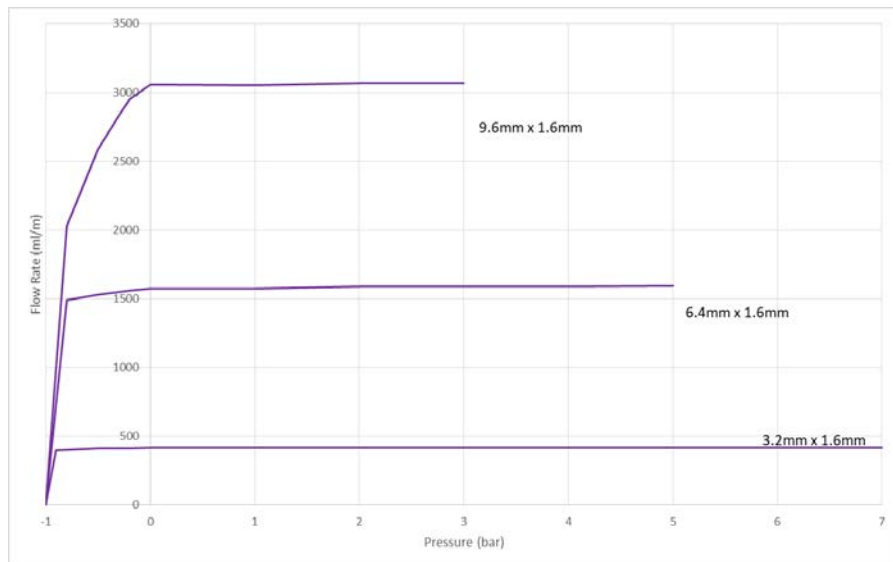

29 Trademarks

Watson-Marlow, LoadSure, Qdos, ReNu, LaserTraceability, Pumpsil, PureWeld XL, Bioprene, Marprene are registered trademarks of Watson-Marlow Limited. Tri-Clamp is a registered trademark of Alfa Laval Corporate AB.

STA-PURE Series PCS and STA-PURE Series PFL are trademarks of W.L.Gore and Associates.

EtherNet/IP™ is a trademark of ODVA, Inc.

Studio 5000® is a trademark of Rockwell Automation.

30 Disclaimers

The information contained in this document is believed to be correct but Watson-Marlow Fluid Technology Group accepts no liability for any errors it contains and reserves the right to alter specifications without notice.

WARNING: This product is not designed for use in and should not be used for, patient-connected applications.

31 Publication history

File	Date of issue	Notes
m-530bpn-en-01 530 Bp/BpN pump	12.15	First release
m-530bpn-en-02 530 Bp/BpN pump	05.17	Issue 2
m-530bpn-en-04 530 Bp/BpN pump	09.18	All versions updated, combined to single source and unified to Issue 4
m-530bpn-en-08 530 Bp/BpN pump	04.20	All versions updated and unified to Issue 8
m-530bpn-en-08.1 530 Bp/BpN pump	09.20	Maxthane tubing data added. Internal version not released.