

**504U/RL**



## Declarations

<b>Declaration of Conformity</b> 	<b><i>When this pump unit is used as a stand alone pump it complies with: Machinery Directive 98/37/EC EN60204-1, Low Voltage Directive 73/23/EEC EN61010-1, EMC Directive 89/336/EEC EN50081-1/EN50082-1.</i></b>
<b>Declaration of Incorporation</b>	<b><i>When this pump unit is to be installed into a machine or is to be assembled with other machines for installations, it must not be put into service until the relevant machinery has been declared in conformity with the Machinery Directive 98/37/EC EN60204-1.</i></b>

Responsible person: Christopher Gadsden, Managing Director, Watson-Marlow Limited, Falmouth, Cornwall TR11 4RU, England. Telephone 01326 370370, Fax 01326 376009.



## Three year warranty

Watson-Marlow Limited warrants, subject to the conditions below, through either Watson-Marlow Limited, its subsidiaries, or its authorised distributors, to repair or replace free of charge, including labour, any part of this product which fails within three years of delivery of the product to the end user. Such failure must have occurred because of defect in material or workmanship and not as a result of operation of the product other than in accordance with the instructions given in this manual.

Conditions of and specific exceptions to the above warranty are:

- Consumable items such as tubing and rollers are excluded.
- Products must be returned by pre-arrangement carriage paid to Watson-Marlow Limited, its subsidiaries, or its authorised distributor.
- All repairs or modifications must have been made by Watson-Marlow Limited, its subsidiaries, or its authorised distributors or with the express permission of Watson-Marlow Limited, its subsidiaries, or its authorised distributors.
- Products which have been abused, misused, or subjected to malicious or accidental damage or electrical surge are excluded.

Warranties purporting to be on behalf of Watson-Marlow Limited made by any person, including representatives of Watson-Marlow Limited, its subsidiaries, or its distributors, which do not accord with the terms of this warranty shall not be binding upon Watson-Marlow Limited unless expressly approved in writing by a Director or Manager of Watson-Marlow Limited.

## Information for returning pumps

Equipment which has been contaminated with, or exposed to, body fluids, toxic chemicals or any other substance hazardous to health must be decontaminated before it is returned to Watson-Marlow Limited or its distributor.

A certificate included at the rear of these operating instructions, or signed statement, must be attached to the outside of the shipping carton.

This certificate is required even if the pump is unused. If the pump has been used, the fluids that have been in contact with the pump and the cleaning procedure must be specified along with a statement that the equipment has been decontaminated.

## Safety

In the interests of safety, this pump and the tubing selected should only be used by competent, suitably trained personnel after they have read and understood this manual, and considered any hazard involved.

Any person who is involved in the installation or maintenance of this equipment should be fully competent to carry out the work. In the UK this person should also be familiar with the Health and Safety at Work Act 1974.

	<p>There are dangerous voltages (at mains potential) inside the pump. If access is required, isolate the pump from the mains before removing the cover.</p>
---	---

### Recommended operating procedures

**DO** keep delivery and suction lines as short as possible using a minimum number of swept bends.

**DO** use suction and delivery pipelines with a bore equal to or larger than the bore of the tube fitted in the pumphead. When pumping **viscous** fluids, the losses caused by increased friction can be overcome by using pipe runs with a cross sectional area several times greater than the pumping element.

**DO** run at a slow speed when pumping viscous fluids. When using the 501RL pumphead, a 4.8 or 6.4mm bore tube with a 1.6mm wall will give best results. Tube smaller than this will generate a high friction pressure loss, so reducing the flow. Tube with a larger bore will not have sufficient strength to resist. Flooded suction will enhance pumping performance in all cases, particularly for materials of a viscous nature. For improved performance with viscous materials or for lighter suction lift and discharge pressure use 2.4mm wall tubing in the 501RL2 pumphead, for speeds up to 200rpm.

**DO** keep the track and rollers clean.

**DO** fit an extra length of pump tube in the system to enable tube transfer. This will extend tube life and minimise the down time of the pumping circuit.

The self-priming nature of peristaltic pumps means valves are not required. Any valves fitted must cause no restriction to flow in the pumping circuit.

**When using Marprene or Bioprene tubing**, after the first 30 minutes of running, re-tension the tube in the pumphead by releasing the tube clamp on the delivery side a little and pulling the tube tight. This is to counteract the normal stretching that occurs with Marprene and Bioprene, which can go unnoticed and result in reduced tube life.

**Tube selection** The chemical compatibility list published in the Watson-Marlow catalogue is only a guide. If in doubt about the compatibility of a tube material and the duty fluid, request a tube sample card for immersion trials.

### Installation

The 504U/RL is suitable for single phase mains electricity supplies only.

To ensure correct lubrication of the gearbox the pump should be run only while its feet are standing on a horizontal surface. The pump should be positioned to allow a free flow of air around it.

- Remove the small transparent plate on the rear panel to gain access to the voltage selector and terminal block.
- Set the voltage selector switch to either 120V for 100-120V 50/60Hz single phase AC supplies or 240V for 220-240V 50/60Hz single phase AC supplies.
- Route the mains supply cable through the entry point to the right of the recess and couple the cable to the terminal block as shown on the rear panel.
- The cable entry accepts three core 0.75 square millimetre PVC sheathed mains cable (via the screw adaptor supplied) so that a mains lead can be used.
- Ensure that the mains lead is securely retained in the strain relief gland so that IP55 ingress protection is maintained.
- Securely replace the transparent plate and the gasket over the recess.

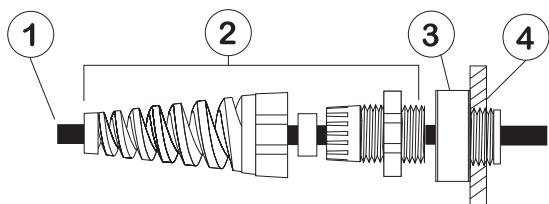

- 1 Power cable 5-8mm O.D. (outside diameter)
- 2 Strain relief gland SL 0020
- 3 Adaptor MR0678T
- 4 M20 Conduit thread for direct conduit connection, through back panel

Ingress protection standard will be compromised if fittings are not correctly replaced.

## Rear panel recess

The pump rear panel recess houses the following:

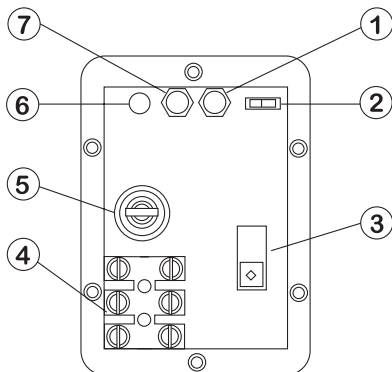

1 Signal offset potentiometer 2 Tachometer switch 3 Voltage selection switch 4 Terminal block  
5 Fuse holder 6 Signal overload LED 7 Signal range potentiometer.

## Troubleshooting

Should the unit fail to operate, make the following checks to determine whether or not servicing is required.

- Check that the power switch is on.
- Check the mains supply is available at the pump unit.
- Check the voltage selector switch is in the correct position.
- Check the fuse in the mains socket.
- Check that the pump is not stalled by incorrect fitting of tubing.

## Manual operation

**Start up direction** Start the pump by turning the **Forward/Off/Reverse** switch to the required direction of rotation. The preferred direction of rotation is clockwise (with fluid entering at the bottom of the right of the pumphead), which will ensure the longest possible tube life. To operate against higher pressures, use counterclockwise rotation.

**Prime** To prime the pump at maximum speed turn the **Auto/Manual/Max** switch on the front panel to its **Max** position. When released the switch will return to its **Manual** position.

**Speed control** The speed setting dial is calibrated in percentage of maximum speed and has a locking knob to prevent accidental speed changes.

**Stop** Stop the pump by turning the **Forward/Off/Reverse** switch to its central **Off** position. To change the direction of flow, turn the **Forward/Off/Reverse** switch to its central **Off** position until the pumphead rotor stops, and turn it to the required direction of rotation.

If returning from auto control to manual control, it is not necessary to disconnect the process signal from the pump or adjust the calibration potentiometers.

## Automatic operation

Set the **Auto/Man/Max** switch to **Auto**.

For all auto and remote control operations, the drive is supplied with a 6 pin waterproof connector (UP 0055).

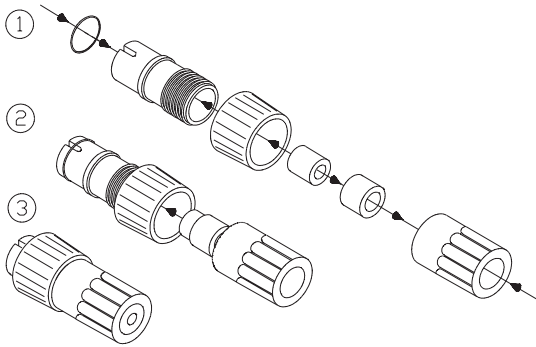

Correct assembly of the 6 pin plug is essential or the ingress protection standard will be compromised. Never apply mains voltage across any pins on the 6 pin socket. Up to 30V may be applied across pins 2 and 3, but not across other pins because permanent damage, not covered by warranty may result.

The pump is controllable by an analogue process signal of up to 30V or 32mA. The pump will provide an increasing flow rate for rising control signals (*non-inverted response*) or an increasing flow rate for falling control signal (*inverted response*).

- **Signal offset** is the process signal level which has to be reached in order for the pump rotor to start rotating.
- **Signal range** is the change in process signal level necessary to produce the required change in pump rotor speed.

For example, when using a 4mA to 20mA process signal:

Pump Response	Signal Offset	Signal range
Non-Inverted	4mA	16mA
Inverted	20mA	16mA

For voltage modes a stable variable DC voltage source can be used in conjunction with a DC voltmeter, (maximum 30V DC) or a remote potentiometer. Polarity set for non-inverted response. Reverse polarity for inverted response.

### Voltage signal

Input impedance 220 kohm

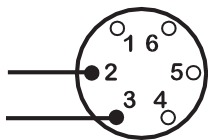

Response	Range V	Offset V	Pin 2	Pin 3
Non-inverted	5 to 30	0 to 30	-	+
inverted	5 to 30	0 to 30	+	-

For current modes the same DC source can be used in conjunction with a DC milliamperemeter. Polarity set for non-inverted response. Reverse polarity for inverted response.

### Current signal

Input impedance 250 ohm

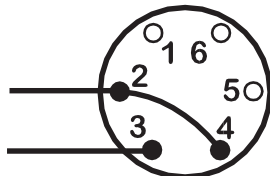

Response	Range mA	Offset mA	Pin 2	Pin 3
Non-inverted	12 to 30	0 to 30	-	+
inverted	12 to 30	0 to 30	+	-

### Calibration for auto control

Ensure the correct wiring of the 6 pin plug and insert the plug into the socket at the rear of the pump.

- Remove the rear panel recess window. Turn the signal offset potentiometer clockwise until the slider traverse limit is reached and is signified by a clicking noise. Now turn the potentiometer ten turns anticlockwise.
- Repeat for the signal range potentiometer. This ensures correct potentiometer set up for calibration. Set the process signal offset.
- Turn the signal offset potentiometer clockwise to set the drive shaft speed to the desired minimum.
- Set the process signal at its upper range limit (not exceeding 30V or 32mA).
- Turn the signal range potentiometer clockwise to set the drive shaft speed to the desired maximum.
- Repeat the procedure until pump response coincides exactly with the process signal.

If the signal rises above its designated maximum, the action of the signal conditioner will be to hold the motor to maximum speed at the MAX setting indicated by the flashing of the LED indicator. If the signal rises above 30V, permanent damage, not covered by warranty, may result.

	<p>Securely replace the rear panel recess on the back of the pump ensuring the gasket is in the correct position. This will avoid the ingress protection standard of the pump unit being compromised.</p>
---	---

### Remote control

#### Stop/Start

Connect remote switch between pins 1 and 5 of the 6 pin socket. Close contact to stop the pump, open to run.

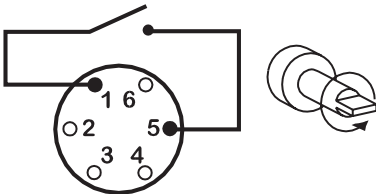

A TTL compatible logic input (Low 0V, High 5V) may be applied to pin 5 (pin 2 common) with 5V High = stop, 0V low = run).

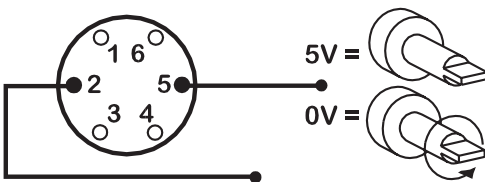

### Speed

A remote potentiometer with a nominal value of between 4.7kohm and 5 kohm should be wired as shown, When using a remote potentiometer do not connect a voltage/current control signal at the same time. The speed control signal will require calibration relative to the minimum and maximum settings of the potentiometer. Use the offset and range potentiometers as described under *Calibration for auto control*.

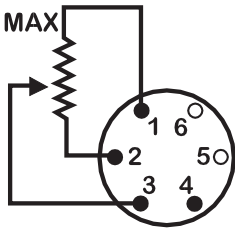

### Tachometer output

This facility can be used to indicate motor speed or total the number of motor revolutions. Select either 1) 0-5V DC or 2) 5V pulse train output using the tachometer output switch.

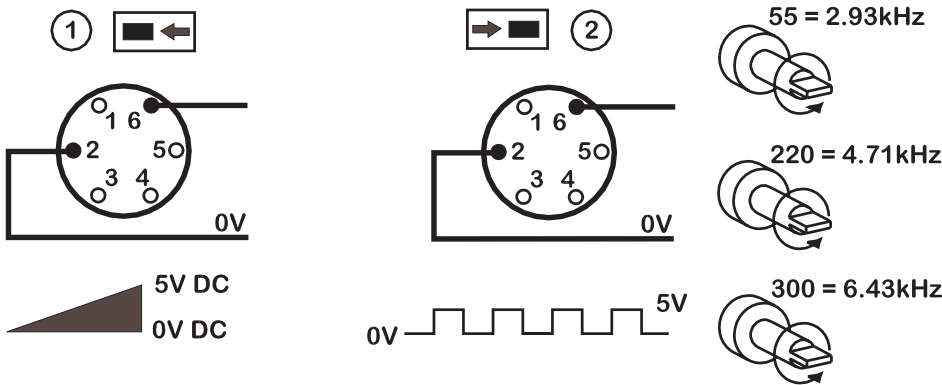

### Care and maintenance

The only scheduled maintenance of the pump unit is to inspect the motor brushes and to replace them before their length is less than 10mm. The life of the brushes depends on the duty of the pump but is expected to be at least 4,000 hours at maximum speed.

If the pump requires cleaning use a mild solution of detergent in water after removing the pumphead. Do not use strong solvents.

For gearbox rebuilds, use 15ml of the recommended lubricant RD-105. This is a SAE 30 mineral oil loaded with molybdenum disulphide to form a soft fluid grease.

### Specification

Maximum rotor speed	55rpm, 220rpm, 300rpm
Shaft torque	2.2Nm
Control range	100:1
Voltage/frequency	100-120/220-240V 50/60Hz
Power consumption	100VA
Operating temperature range	5C to 40C
Storage temperature range	-40C to 70C
Noise	<70dB(A) at 1m
Weight	9.0kg
Standards	EN60529 (IP55)
	Machinery Directive 98/37/EC EN60204-1
	Low Voltage Directive 73/23/EEC EN61010-1
	EMC Directive 89/336/EEC EN50081-1/EN50082-1

## 501RL Pumphead

The 501RL pumphead has two spring-loaded working rollers, which automatically compensate for minor variations in tubing wall thickness, giving extended tube life. The 501RL is set during manufacture to accept tubing with wall thicknesses of between 1.6mm and 2.0mm, and internal diameters of up to 8.0mm. It is equipped with a “tool lockable” guard for increased safety. This should be locked shut whilst the pump is in use. The pumphead can be run clockwise for extended tube life, or anti-clockwise to operate against higher pressures.

### Flow rates

Flow rates for the 504U were obtained using silicone tubing with the pumphead rotating clockwise, pumping water at 20C with zero suction and delivery pressures. For critical applications determine flow rates under operating conditions.

### Installation

Remove the grub screws on the drive front panel to enable the pumphead to be fitted.



Fit the track in any one of three orientations, over the drive shaft and locating boss. Secure the track with the locating screw. Ensure the drive shaft is degreased before locating the rotor onto the shaft via the split collet. *Rotate the rotor until its guide rollers are aligned flush to the front edge of the track.* Tighten the rotor screw to a torque of 3Nm to prevent the collet slipping during operation.

To reposition the track, swing out the crank handle to expose the rotor retaining screw. Turn the screw anticlockwise one turn to release the collet, and withdraw the rotor from the shaft. Loosen the track locating screw, and pull the track clear. Rotate the track to its new position and tighten the track locating screw. Use this method of removal and fitting if cleaning is required.

### Tube loading

Isolate pump from mains supply. Unlock and open the hinged guard and swing out the rotor crank handle until it locks into position. Select the length of tubing required, noting that approximately 240mm is required for the 501RL track.

Fit one end of the tubing into one of the spring loaded clamps, and then, whilst rotating the rotor with the crank handle, feed the tubing between the rollers and the track, aligning it within the rotor tube guides. The tubing must lie naturally against the track and must not be twisted or stretched.





Fit the other end of the tubing into the second spring loaded clamp, ensuring that the tubing is not slack in the pumphead, since this can reduce tube life.

Close the crank handle and shut and lock the guard.

After the pump has been started, open the downstream clamp for a short time, so that the tube can find its natural length.

The 501RL pumphead is fitted with four-position tube clamps, to accommodate various tube diameters, which can be adjusted by pushing in or pulling out the bars at the top of the upper clamp and the bottom of the lower clamp. Set the clamps so that the minimum necessary pressure is applied to the tubing.



### **Roller adjustment**

The 501RL has a factory set gap of 2.6mm between the rollers and the track and is suitable for tubing having wall thicknesses of between 1.6 and 2.0mm. Adjustment of the gap will be required if tubing having a wall thickness of less than 1.6mm is required. There is an adjusting screw on each of the two roller arms, and each of these screws will require adjustment. The correct gap is twice the wall thickness less twenty percent. Correct adjustment is important: over occlusion will reduce tube life; under occlusion will reduce pumping efficiency.

To change the gap setting, turn each adjusting screw clockwise to increase the gap, or anticlockwise to decrease the gap. A full turn changes the gap by 0.8mm.

To restore the original settings of 2.6mm, turn the adjusting screws until both rollers are just touching the track, then tighten each screw by three and a quarter turns. The 501RL2 has a factory set gap of 3.8mm between the wall and the track and is suitable for tubing having wall thickness of between 2.1 and 2.5mm.

Check moving parts of the rotor from time to time for freedom of movement. Lubricate pivot points and rollers occasionally with a light machine oil with Teflon additives. For scheduled maintenance, remove the rotor from the pumphead, clean thoroughly and apply light machine oil with Teflon additives to the roller spindles.

## Pumphead spares

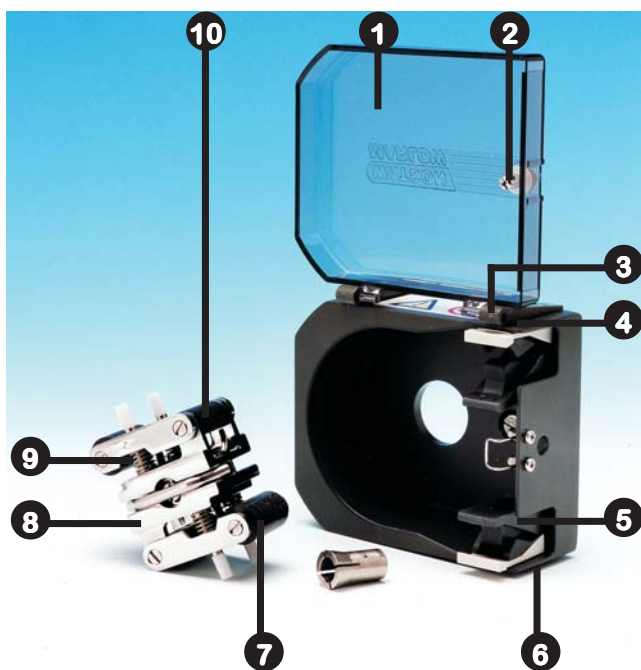

Number	Spare	Description
1	MN 1200M	Lockable guard
2	FN 4502	Lock
3	FN 2341	Hinge screw
4	MN 0266M	Hinge grey
5	MNA0114A	Tube clamp assembly
6	FN 2332	Screw
7	MN 0011T	Main roller
8	MNA0143A	501RL Rotor Assembly
9	SG0001/SG0002	Springs standard (1.6mm) / hard (2.4mm)
10	MN 0012T XX 0095	Follower roller Teflon lubricant

## Drive spares

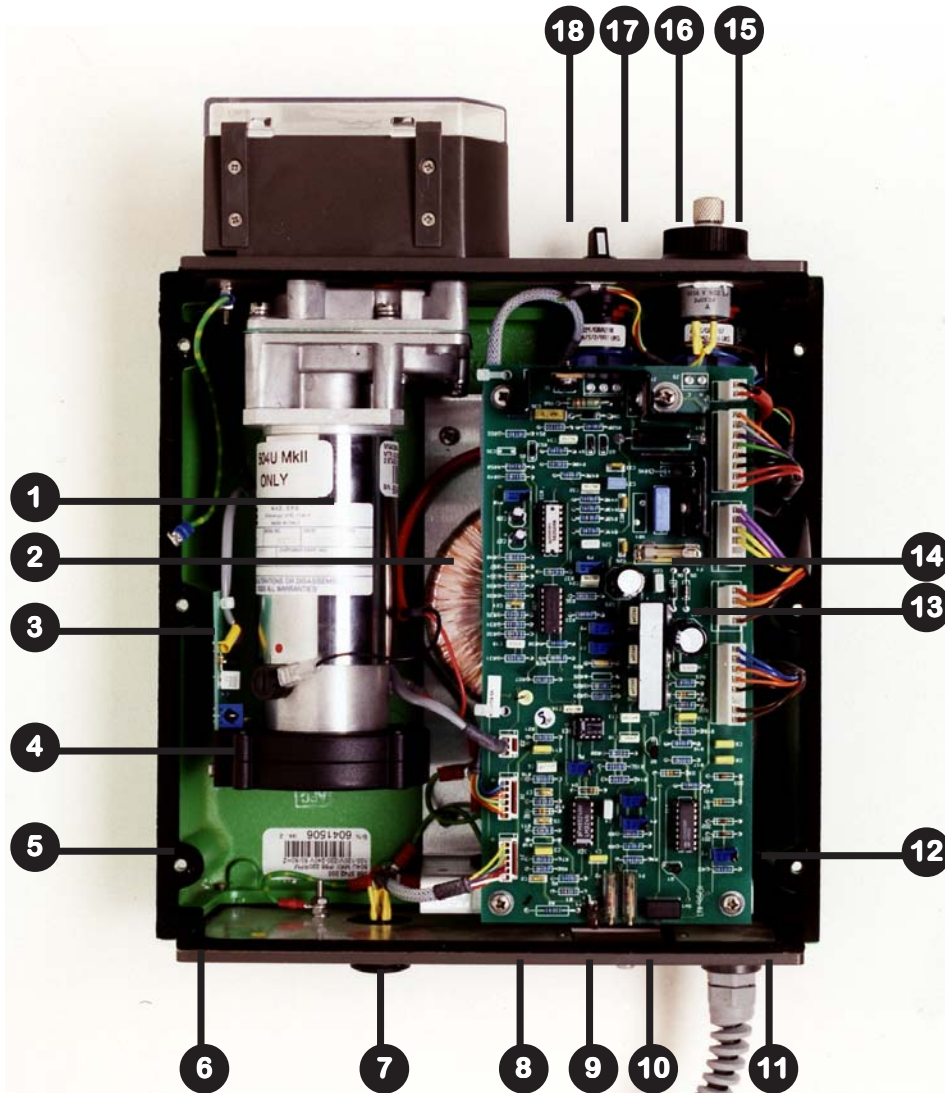

Number	Spare	Description
1	MNA0388A	Motor/gearbox 220rpm/ 300rpm
1	MNA0396A	Motor/gearbox 55rpm
2	MRA0613A	Transformer
3	MNA0543A	Tachometer PCB
4	MN0787M	Tachometer disc
5	MN0487S	Top/bottom case gasket
6	MN0488S	Front/rear panel gasket
7	UP0055	6 pin plug
	US0055	6 pin socket
8	SW0086	Voltage selector switch
9	FS0024	Fuse T type 2 amp
10	MR0669S	Window cover plate
11	SL0020	Cable gland
12	FA 0002	Filter
13	MNA0546A	PCB assembly 55rpm, 220rpm
	MNA0639A	PCB assembly 300rpm
14	FS0028	Fuse T type 0.4 amp
15	MR0769B	Potentiometer
16	SW0110	Direction switch
17	FN0477	Blanking screws
18	SW0109	Auto/manual/max switch

Specific drive performance details such as loaded drive speed variation against mains supply voltage fluctuation and drive stability from a cold start to normal operating temperature are available on request. For further information please contact Watson-Marlow Technical Support Department.

<b>English</b>	Tube number	Tube bore	rpm	Stop

<b>English</b>	Pressure (+)	Suction	clockwise rpm	anti-clockwise rpm

## 501RL

### Flow rates

	#	112	13	14	16	25	17	18
	mm	0.5	0.8	1.6	3.2	4.8	6.4	8.0
	"	1/50	1/32	1/16	1/8	3/16	1/4	5/16
	55	2.3	6.7	24	100	220	350	550
	220	9.2	27	94	410	890	1400	2200

## 501RL2

### Flow rates





	#	14	16	25	17	18
	mm	1.6	3.2	4.8	6.4	8.0
	"	<b>1/16</b>	<b>1/8</b>	<b>3/16</b>	<b>1/4</b>	<b>5/16</b>
	55	40	125	230	385	495
	220	155	500	925	1540	1980

## 313/314 (ml/min)





### Flow rates

	#	112	13	14	16	25	17	18
	mm	0.5	0.8	1.6	3.2	4.8	6.4	8.0
	"	1/50	1/32	1/16	1/8	3/16	1/4	5/16
<b>313</b>								
	<b>55</b>	1.5	3.9	15	55	121	198	275
	<b>220</b>	6.6	15	60	220	484	792	1100
<b>314</b>								
	<b>55</b>	1.5	3.3	13	46	104	165	220
	<b>220</b>	6.6	13	55	186	418	660	880

## Maximum number of pumpheads



313/314 Peroxide/ Platinum silicone																
	#	112	13	14	16	25	17	18		112	13	14	16	25	17	18
	mm	0.5	0.8	1.6	3.2	4.8	6.4	8.0		0.5	0.8	1.6	3.2	4.8	6.4	8.0
	"	1/50	1/32	1/16	1/8	3/16	1/4	5/16		1/50	1/32	1/16	1/8	3/16	1/4	5/16
	55	6	6	6	6	6	4	3		6	6	6	6	5	3	3
	220	6	6	6	6	6	4	3		6	6	6	6	5	3	3



313/314 Marprene, Tygon, Neoprene, Fluorel																
	#	112	13	14	16	25	17	18		112	13	14	16	25	17	18
	mm	0.5	0.8	1.6	3.2	4.8	6.4	8.0		0.5	0.8	1.6	3.2	4.8	6.4	8.0
	"	1/50	1/32	1/16	1/8	3/16	1/4	5/16		1/50	1/32	1/16	1/8	3/16	1/4	5/16
	55	6	6	6	6	5	3	3		6	6	6	6	4	3	3
	220	6	6	6	6	5	3	3		6	6	6	6	4	3	3

## 501RL, 501RLG, 313, 314



Product codes

						
mm	"	#	Marprene	Bioprene	Peroxide Silicone	Platinum Silicone
0.5	1/50	112	<b>902.0005.016</b>	<b>903.0005.016</b>	<b>910.0005.016</b>	<b>913.A005.016</b>
0.8	1/32	13	<b>902.0008.016</b>	<b>903.0008.016</b>	<b>910.0008.016</b>	<b>913.A008.016</b>
1.6	1/16	14	<b>902.0016.016</b>	<b>903.0016.016</b>	<b>910.0016.016</b>	<b>913.A016.016</b>
3.2	1/8	16	<b>902.0032.016</b>	<b>903.0032.016</b>	<b>910.0032.016</b>	<b>913.A032.016</b>
4.8	3/16	25	<b>902.0048.016</b>	<b>903.0048.016</b>	<b>910.0048.016</b>	<b>913.A048.016</b>
6.4	1/4	17	<b>902.0064.016</b>	<b>903.0064.016</b>	<b>910.0064.016</b>	<b>913.A064.016</b>
8.0	5/16	18	<b>902.0080.016</b>	<b>903.0080.016</b>	<b>910.0080.016</b>	<b>913.A080.016</b>



						
mm	"	#	STA-PURE*	Chem-Sure*	Neoprene	Tygon
0.8	1/32	13			<b>920.0008.016</b>	
1.6	1/16	14	<b>960.0016.016</b>	<b>965.0016.016</b>	<b>920.0016.016</b>	<b>950.0016.016</b>
3.2	1/8	16	<b>960.0032.016</b>	<b>965.0032.016</b>	<b>920.0032.016</b>	<b>950.0032.016</b>
4.8	3/16	25	<b>960.0048.016</b>	<b>965.0048.016</b>	<b>920.0048.016</b>	<b>950.0048.016</b>
6.4	1/4	17	<b>960.0064.016</b>	<b>965.0064.016</b>	<b>920.0064.016</b>	<b>950.0064.016</b>
8.0	5/16	18	<b>920.0080.016</b>	<b>965.0080.016</b>	<b>920.0080.016</b>	<b>950.0080.016</b>



				
mm	"	#	Fluorel	Butyl
1.6	1/16	14	<b>970.0016.016</b>	<b>930.0016.016</b>
3.2	1/8	16	<b>970.0032.016</b>	<b>930.0032.016</b>
4.8	3/16	25	<b>970.0048.016</b>	<b>930.0048.016</b>
6.4	1/4	17	<b>970.0064.016</b>	<b>930.0064.016</b>
8.0	5/16	18	<b>970.0080.016</b>	<b>930.0080.016</b>

## 501RL2, 501RL2G

Product codes

 mm	 "	Peroxide Silicone	Platinum Silicone	Marprene	Bioprene
1.6	1/16	910.0016.024	913.A016.024	902.0016.024	903.0016.024
3.2	1/8	910.0032.024	913.A032.024	902.0032.024	903.0032.024
4.8	3/16	910.0048.024	913.A048.024	902.0048.024	903.0048.024
6.4	1/4	910.0064.024	913.A064.024	902.0064.024	903.0064.024
8.0	5/16	910.0080.024	913.A080.024	902.0080.024	903.0080.024
9.6	3/8	910.0096.024	913.A096.024	902.0096.024	903.0096.024



  

 mm	 "	STA-PURE*	Chem-Sure*
1.6	1/16	960.0016.024	965.0016.024
3.2	1/8	960.0032.024	965.0032.024
4.8	3/16	960.0048.024	965.0048.024
6.4	1/4	960.0064.024	965.0064.024
8.0	5/16	960.0080.024	965.0080.024

\* 501RL2G

## 505L, 505LG

(2.4mm) Product codes

 mm	 "	 #	Peroxide Silicone	Platinum Silicone	Marprene	STA-PURE	Chem-Sure	
1.6	1/16	119	910.E016.024	913.AE16.024	902.E016.024	960.E016.K24	965.E016.K24	
3.2	1/8	120	910.E032.024	913.AE32.024	902.E032.024	960.E032.K24	965.E032.K24	
4.8	3/16	15	910.E048.024	913.AE48.024	902.E048.024	960.E048.K24	965.E048.K24	
6.4	1/4	24	910.E064.024	913.AE64.024	902.E064.024	960.E064.K24	965.E064.K24	
8.0	5/16	121	910.E080.024	913.AE80.024	902.E080.024	960.E080.K24	965.E080.K24	
9.6	3/8	122	910.E096.024	913.AE96.024	902.E096.024			
9.6	3/8	122	910.H096.024 (high flow element)					

## Outline dimensions

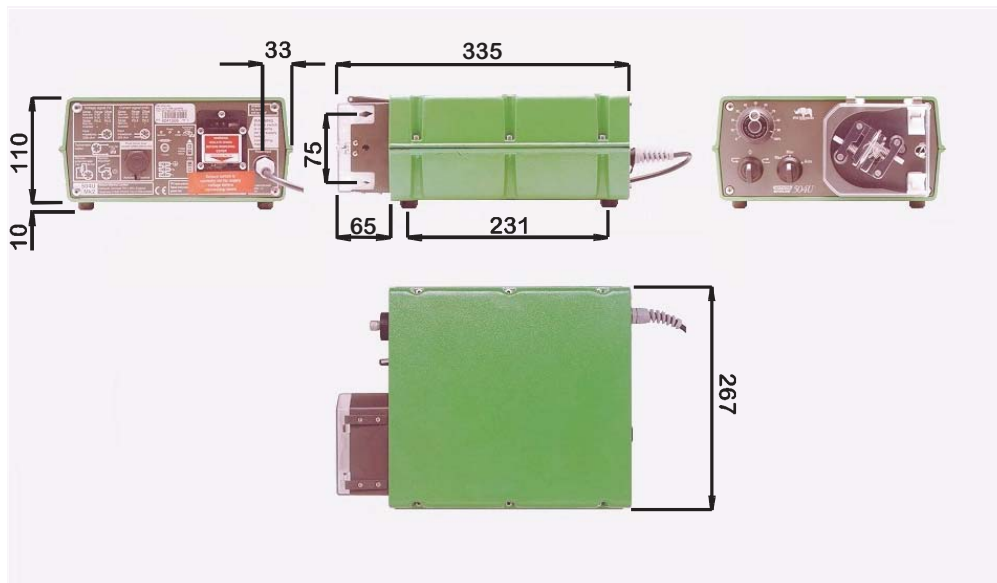

## 501RL

### Flow rates

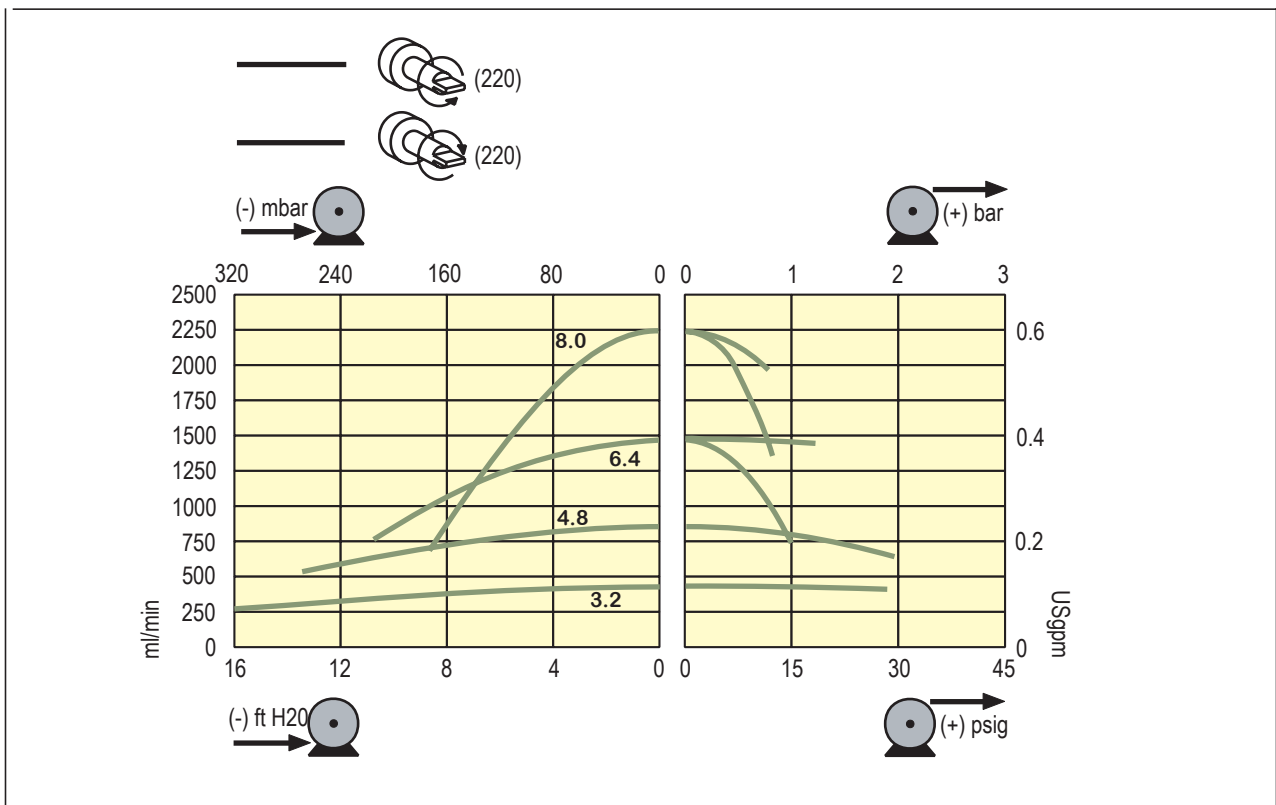



---

**Watson-Marlow, Bioprene and Marprene** are trademarks of **Watson-Marlow Limited**.

**Tygon** is a trademark of the **Saint Gobain Performance Plastics** Company.

**STA-PURE** and **Chem-sure** are trademarks of **W L Gore & Associates**

**Warning, These products are not designed for use in, and should not be used for patient connected applications.**

The information contained in this document is believed to be correct but Watson-Marlow Limited accepts no liability for any errors it contains, and reserves the right to alter specifications without notice.

---

## Product Use and Decontamination Certificate

In compliance with the **UK Health & Safety at Work Act** and the **Control of Substances Hazardous to Health Regulations** you, the user are required to declare the substances which have been in contact with the product(s) you are returning to Watson-Marlow or any of its subsidiaries or distributors. Failure to do so will cause delays in servicing the product. Therefore, **please complete this form** to ensure that we have the information **before** receipt of the product(s) being returned. **A FURTHER COPY MUST BE ATTACHED TO THE OUTSIDE OF THE PACKAGING CONTAINING THE PRODUCT(S).** You, the user, are responsible for cleaning and decontaminating the product(s) before returning them.

Please complete a separate Decontamination Certificate for each pump returned.

**RGA No:** .....

1. Company .....

Address .....

Postcode .....

Telephone ..... Fax number .....

2. Product .....

2.1 Serial number .....

2.2 Has the product been used?

YES		NO	
-----	--	----	--

If yes, please complete all the following Sections. If no, please complete Section 5 only

<p>3. Details of substances pumped</p> <p>3.1 Chemical names</p> <p>(a) .....</p> <p>(b) .....</p> <p>(c) .....</p> <p>(d) .....</p> <p>3.2 Precautions to be taken in handling these substances</p> <p>(a) .....</p> <p>(b) .....</p> <p>(c) .....</p> <p>(d) .....</p>	<p>3.3 Action to be taken in the event of human contact</p> <p>(a) .....</p> <p>(b) .....</p> <p>(c) .....</p> <p>(d) .....</p> <p>3.4 Cleaning fluid to be used if residue of chemical is found during servicing</p> <p>(a) .....</p> <p>(b) .....</p> <p>(c) .....</p> <p>(d) .....</p>
--	---

Note: Please describe current faults .....

.....

.....

.....

4. I hereby confirm that the only substances(s) that the equipment specified has pumped or come into contact with are those named, that the information given is correct, and the carrier has been informed if the consignment is of a hazardous nature.

5. Signed .....

Name .....

Position .....

Date .....