

















Fittings for Science and Industry



Contents

		Page	Page
Tube to tube fittings		For flexible	For semi rigid
Straight connectors, equal legs		2	11
Straight reductions		3	11
Y-connectors, equal legs		5	11
Elbow connectors, equal legs		7	11
Elbow reductions		8	–
T-connectors, equal legs		8	12
T-connectors, reductions		10	12
Plugs		10	–
Luer fittings		For flexible tubing	For semi rigid tubing
Luer connectors		14	16
Luer to Luer connectors and Plugs		14	–
Luer to thread connectors		15	–
Panel mount fittings		For flexible tubing	For semi rigid tubing
Tube to tube and tube to luers		17	–
Threaded fittings		For flexible tubing	For semi rigid tubing
Straight connectors, thread to tube		19	27
Elbow connectors, thread to tube		21	–
T-connectors, thread to tube		23	–
Threaded plugs		26	–
Threaded reductions		26	–
Technical			
Barb design		27	
Fitting materials		28	
Chemical compatibility chart		31	

Straight connectors, equal legs

For flexible tubing

1.6 mm ID
N004-6005

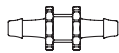

3.2 mm ID
N013-6005

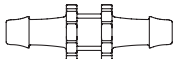

3.2 mm ID
N230-6005

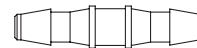

4.8 mm ID
N035-6005

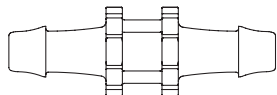

6.4 mm ID
N055-6005

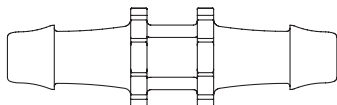

9.6 mm ID
N670-6005

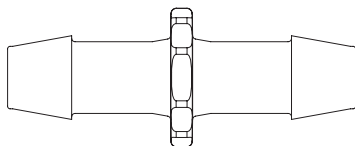

12.7 mm ID
N680-6005

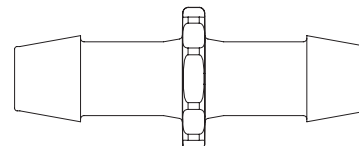

Straight reductions

For flexible tubing

2.4 mm ID to 1.6 mm ID
N007/004-6005

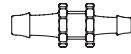

3.2 mm ID to 1.6 mm ID
N013/004-6005

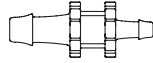

3.2 mm ID to 2.4 mm ID
N230/220-6005

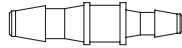

4.8 mm ID to 3.2 mm ID
N035/013-6005

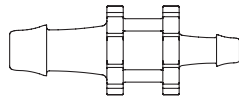

6.4 mm ID to 3.2 mm ID
N055/013-6005

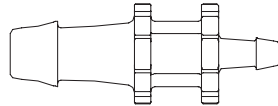

6.4 mm ID to 4.8 mm ID
N055/035-6005

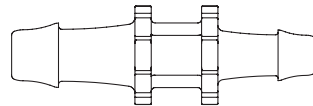

8.0 mm ID to 4.8 mm ID
N065/035-6005

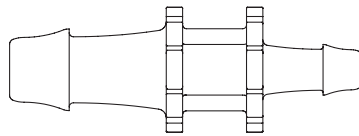

9.6 mm ID to 3.2 mm ID
N070/013-6005

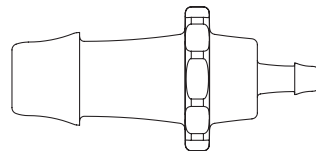

9.6 mm ID to 8.0 mm ID
C6-5WP

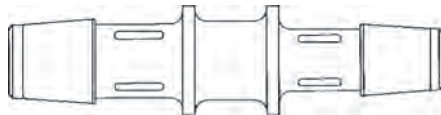

3.2 mm ID to 1.6 mm ID

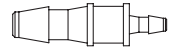

3.2 mm ID to 2.4 mm ID
N013/007-6005

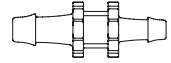

4.8 mm ID to 4.0 mm ID
N035/025-6005

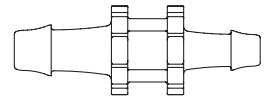

6.4 mm ID to 4.0 mm ID
N055/025-6005

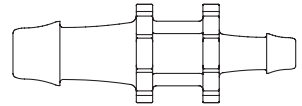

8.0 mm ID to 6.4 mm ID
N065/055-6005

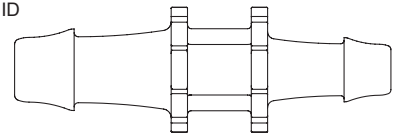

9.6 mm ID to 6.4 mm ID
N670/655-6005

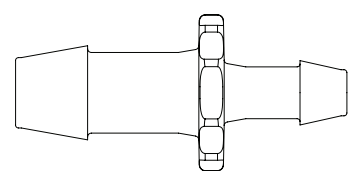

12.7 mm ID to 6.4 mm ID
C8-4WP

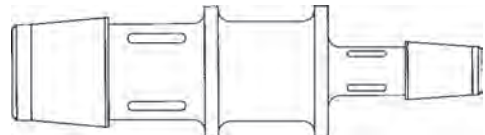

Straight reductions

For flexible tubing

12.7 mm ID to 8.0 mm ID

C8-5WP

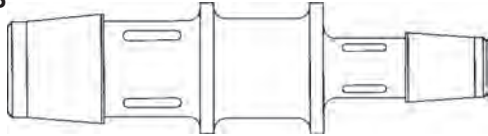

12.7 mm ID to 9.6 mm ID

C8-6WP

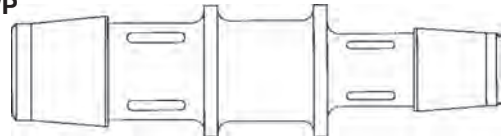

16.0 mm ID to 6.4 mm ID

C10-4WP

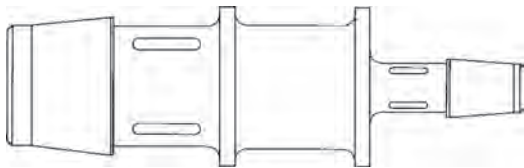

16.0 mm ID to 8.0 mm ID

C10-5WP

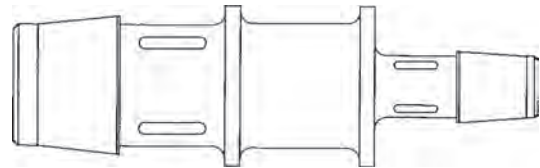

16.0 mm ID to 9.6 mm ID

C10-6WP

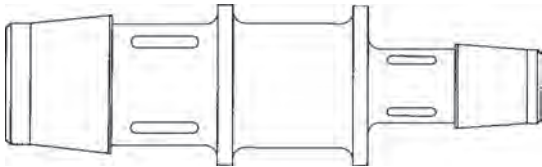

16.0 mm ID to 12.7 mm ID

C10-8WP

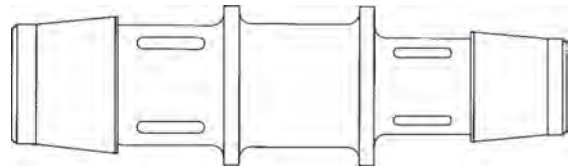

19.2 mm ID to 9.6 mm ID

C12-6WP

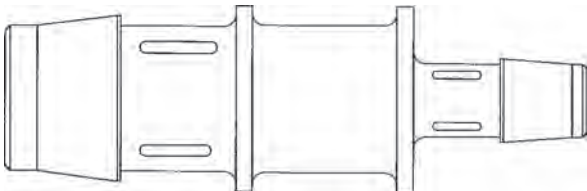

19.2 mm ID to 12.7 mm ID

C12-8WP

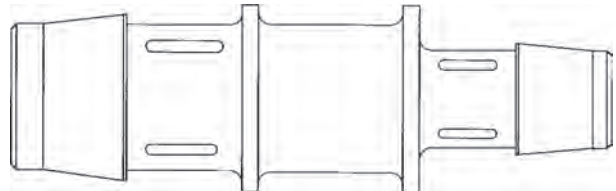

19.2 mm ID to 16.0 mm ID

C12-10WP

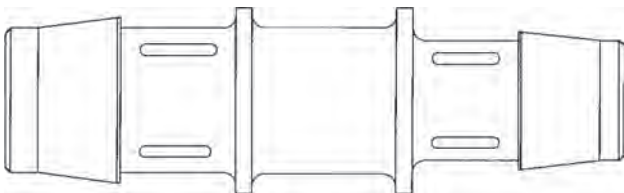

25.4 mm ID to 12.7 mm ID

C16-8WP

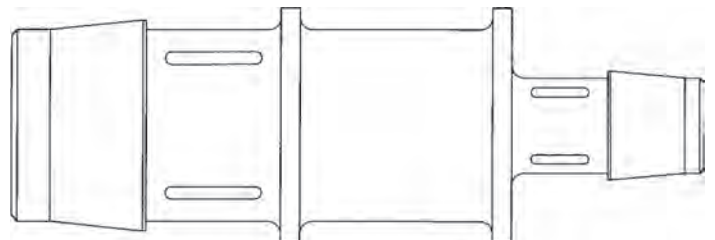

Straight reductions

For flexible tubing

25.4 mm ID to 16.0 mm ID
C16-10WP

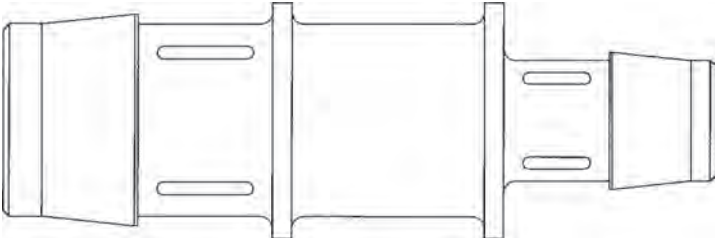

25.4 mm ID to 19.2 mm ID
C16-12WP

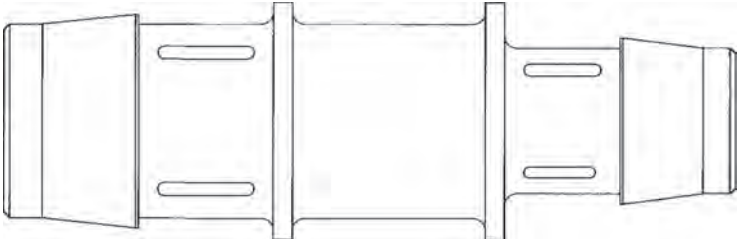

Also see the Panel Mount section for further tube to tube options.

Y-connectors, equal legs

For flexible tubing

1.6 mm ID
Y210-6005



2.4 mm ID
Y220-6005

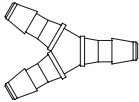

3.2 mm ID
Y230-6005

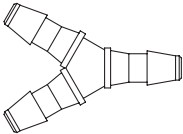

4.0 mm ID
Y240-6005

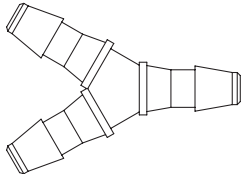

4.8 mm ID
Y250-6005

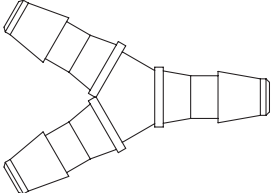

6.4 mm ID
Y260-6005

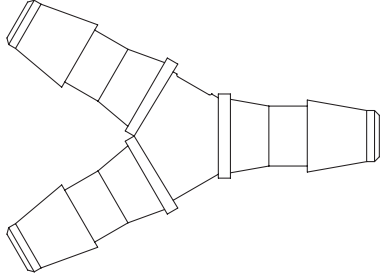

Y-connectors, equal legs

For flexible tubing

9.5 mm ID
Y670-6005

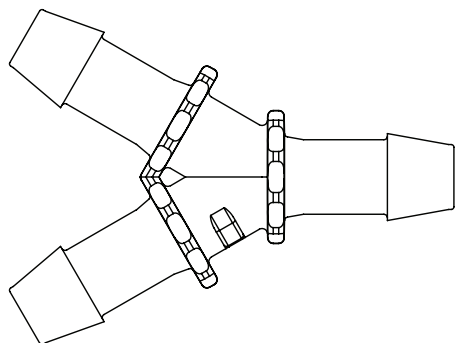

12.7 mm ID
Y680-6005
16.0 mm ID
Y0-10WP

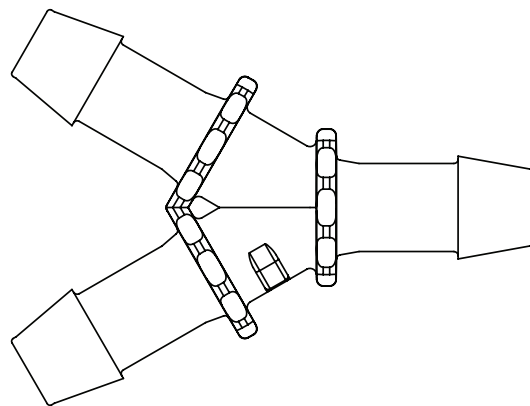

19.2 mm ID
Y100-6005
25.4 mm ID
Y110-6005

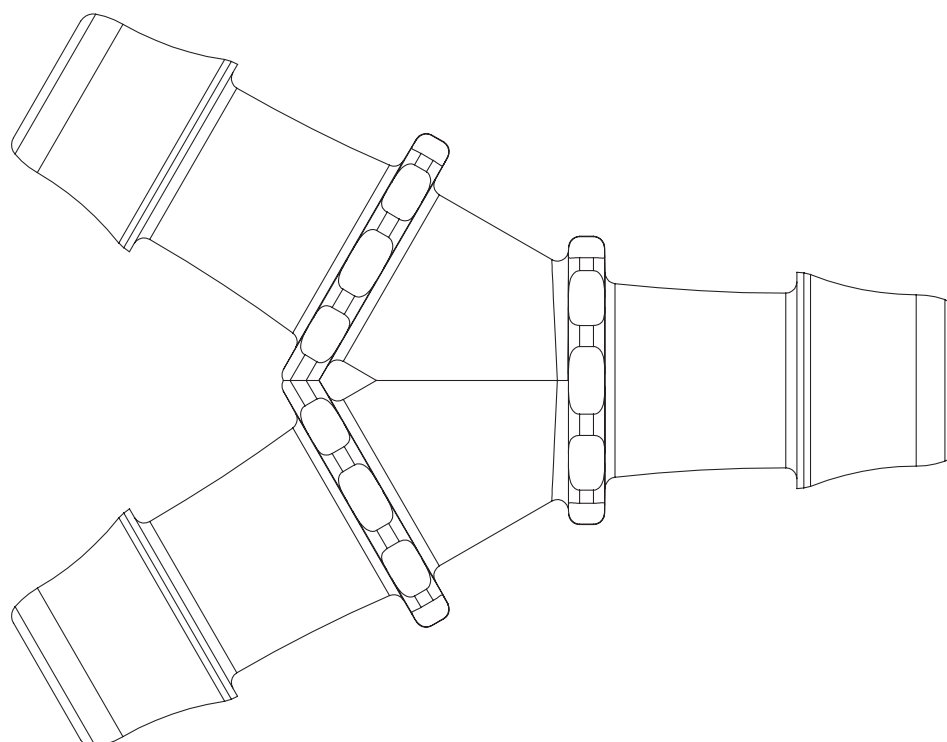

In addition to the Y-connectors in polypropylene shown above, Kynar/PVDF Y-connectors and a wide range of stainless steel manifolds are available from www.flexicon.dk

Product codes are for standard material, see the technical section. For additional materials, please see our price list, or contact your local Watson-Marlow distributor. ID = Tubing inner diameter. All illustrations in scale 1:1.

Elbow connectors, equal legs

For flexible tubing

1.6 mm ID
L210-6005



2.4 mm ID
L220-6005



3.2 mm ID
L230-6005

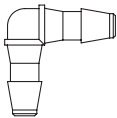

4.0 mm ID
L40-6005

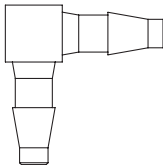

6.4 mm ID
L60-6005

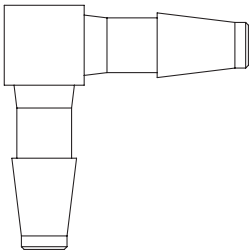

9.6 mm ID
L070-6005

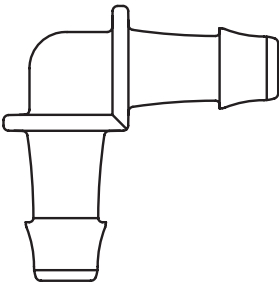

12.7 mm ID
L080-6005

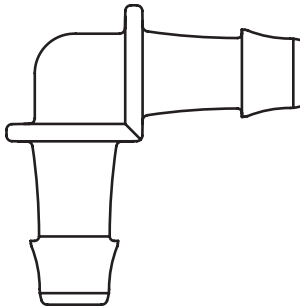

19.2 mm ID
L100-6005
25.4 mm ID
L0-16WP

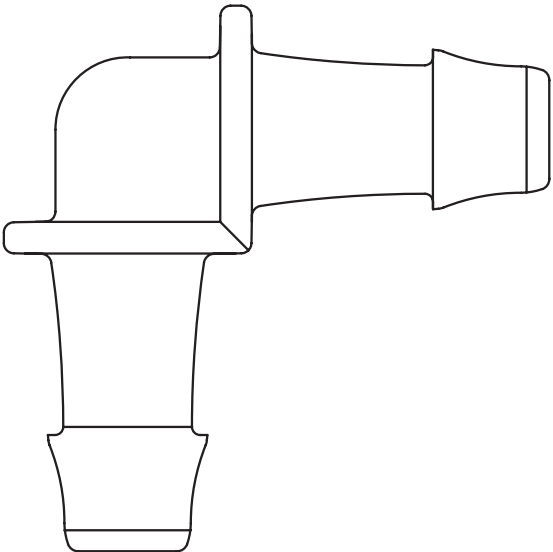

Elbow, reductions

For flexible tubing

2.4 mm ID to 1.6 mm ID
L220/210-6005



3.2 mm ID to 1.6 mm ID
L230/210-6005

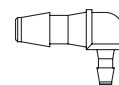

3.2 mm ID to 2.4 mm ID
L230/220-6005

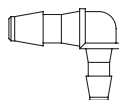

T-connectors, equal legs

For flexible tubing

1.6 mm ID
T210-6005



2.4 mm ID
T220-6005

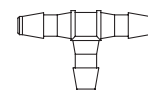

3.2 mm ID
T230-6005

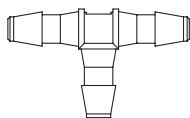

4.0 mm ID
T40-6005

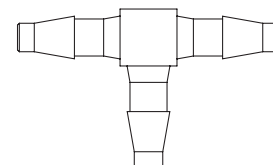

6.4 mm ID
T60-6005

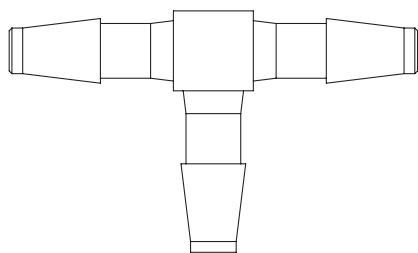

9.5 mm ID
T670-6005

12.7 mm ID
T680-6005

16.0 mm ID
T690-6005

19.0 mm ID
T100-6005

25.4 mm ID

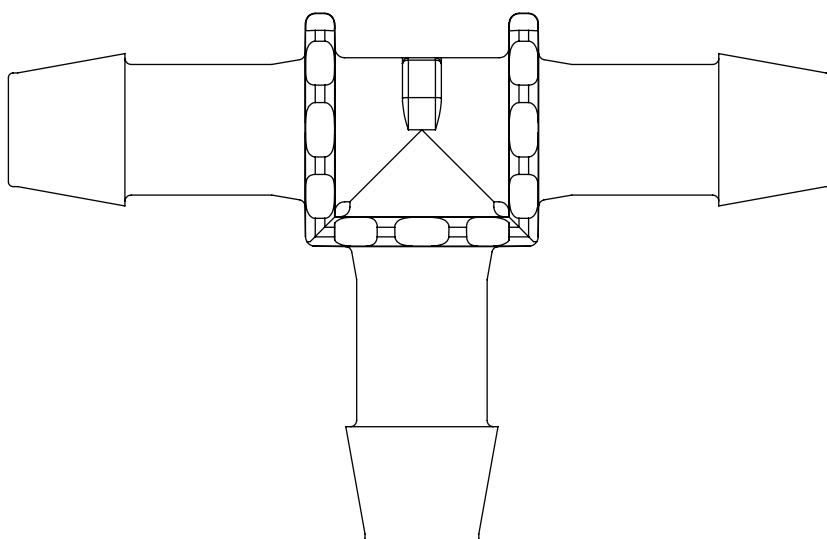

T-connectors, reductions

For flexible tubing

One 2.4 mm ID to two 1.6 mm ID
T210/220-6005

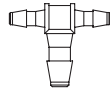

One 3.2 mm ID to two 1.6 mm ID
T210/230-6005

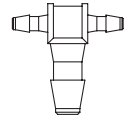

One 3.2 mm ID to two 2.4 mm ID
T220/230-6005

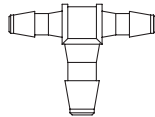

One 1.6 mm ID to two 2.4 mm ID
T220/210-6005

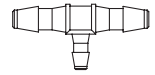

One 1.6 mm ID to two 3.2 mm ID
T230/210-6005

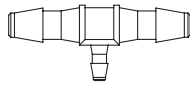

One 2.4 mm ID to two 3.2 mm ID
T230/220-6005

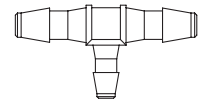

Plugs

For flexible tubing

2.4 mm ID
PIP220-6005



3.2 mm ID
PIP230-6005



4.8 mm ID
PIP50-6005

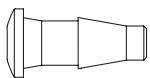

6.4 mm ID
PIP60-6005

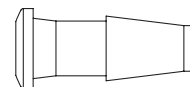

9.6 mm ID
PIP070-6005

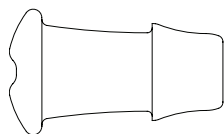

12.7 mm ID
PIP080-6005

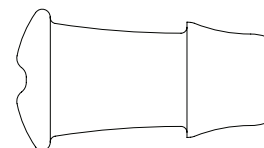

Tube to tube connectors

For semi-rigid tubing

Straight connectors, equal legs

for 1.6 mm ID
N410-6005



for 2.4 mm ID
N420-6005

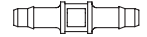

for 3.2 mm ID
N430-6005



for 4.0 mm ID
N440-6005



Straight reductions

2.4 mm ID to 1.6 mm ID
N420/410-6005

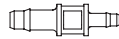

3.2 mm ID to 2.4 mm ID
N430/420-6005



Y-connectors, equal legs

for 1.6 mm ID
Y410-6005



for 2.4 mm ID
Y420-6005

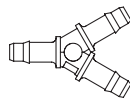

for 4.8 mm ID
Y450-6005

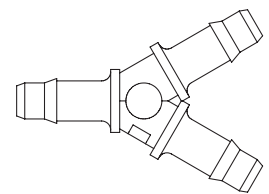

for 3.2 mm ID
Y430-6005

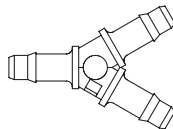

for 6.4 mm ID
Y460-6005

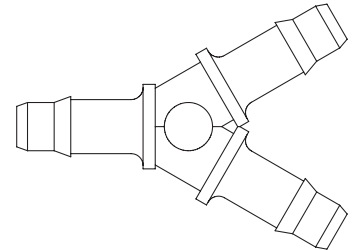

Elbow connectors, equal legs

for 1.6 mm ID
L410-6005



for 2.4 mm ID
L420-6005



for 3.2 mm ID
L430-6005

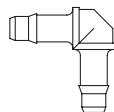

Tube to tube connectors

For semi-rigid tubing

T-connectors, equal legs

for 2.4 mm ID
T420-6005

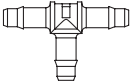

for 3.2 mm ID
T430-6005

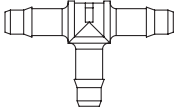

T-connectors, reductions

One 2.4 mm ID to two 1.6 mm ID legs
T410/420-6005

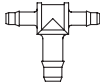

One 3.2 mm ID to two 1.6 mm ID legs
T410/430-6005

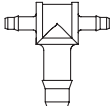

Luer Taper Standards

All luers are made to ANSI/HIMA and ISO Standards MD70-1-1983, ISO 594-1-2 and may be connected to other luers which meet these standards. Please test your application to verify performance of your interconnection.

All Male Luers connect to all Females

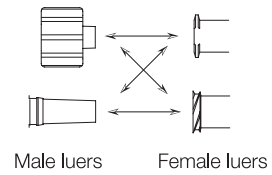

Luer connectors

For flexible tubing

Male Luer, integral fixed lock ring

for 1.6 mm ID
MTLL004-6005

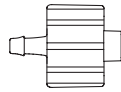

for 2.4 mm ID
MTLL007-6005

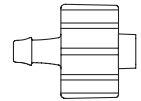

for 3.2 mm ID
MTLL013-6005

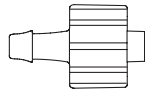

for 4.0 mm ID
MTLL025-6005

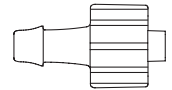

for 4.8 mm ID
MTLL035-6005

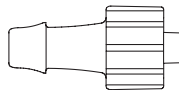

for 6.4 mm ID
MTLL055-6005

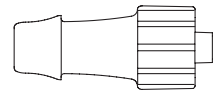

Male Luer for separate rotating lock ring (Lock ring FSLLR is sold separately)

for 1.6 mm ID
MLRL004-6005

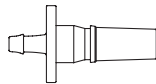

for 2.4 mm ID
MLRL007-6005

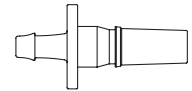

for 3.2 mm ID
MLRL013-6005

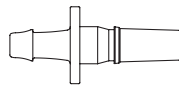

for 4.0 mm ID
MLRL025-6005

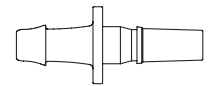

for 4.8 mm ID
MLRL035-6005

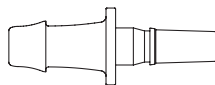

Luer connectors

For flexible tubing

Male Luer rotating lock ring

Lock ring (colour coded)
FSLLR-6005



Female Luer

for 1.6 mm ID
FTLL004-6005

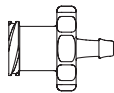

for 2.4 mm ID
FTLL007-6005

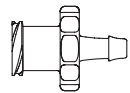

for 3.2 mm ID
FTLL013-6005

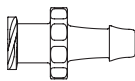

for 4.0 mm ID
FTLL025-6005

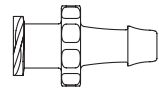

for 4.8 mm ID
FTLL035-6005

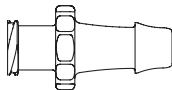

for 6.4 mm ID
FTLL055-6005

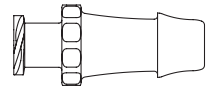

Luer to Luer connectors and Plugs

For flexible tubing

Male to Male Coupler*
MLRLC-6005

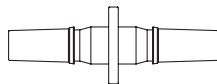

Female Elbow
FTLLE-6005

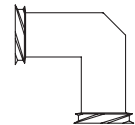

Female T
FTLT-6005

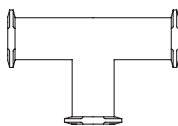

Female to Female Coupler
FTLLC-6005

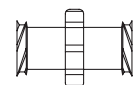

Male to Female Elbow*
LE87-6005

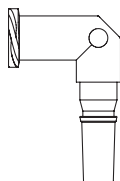

Male (2ea) to Female T*
LT787-6005

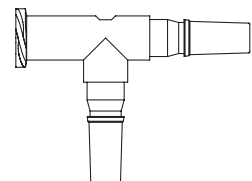

Female (2ea) to Male T*
LT878-6005

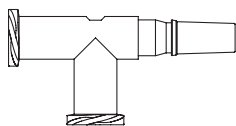

Male Luer Plug
LP4-6005



Female Luer Plug
FTLLP-6005



Male/female Luer Plug
LP34-6005



* May be used with separate rotating lock ring

Luer to thread connectors

For flexible tubing

Male Luer

to 1/4-18 NPT, Integral Lock Ring
14MTLL-6005

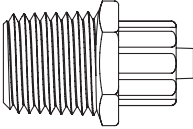

* May be used with separate rotating lock ring FSLLR.

Female Luer

to 1/4-28 UNF
SFTLL-6005

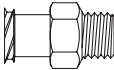

to 10-32 tapered
XFTLL-6005

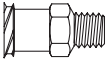

to 1/8-27 NPT
18FTLL-6005

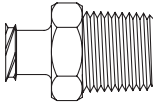

Elbow to 1/8-27 NPT
18LFTLL-6005

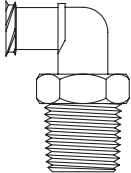

**See Thread section for thread specifications.
Also see the Panel Mount section for further Luer options.**

Luer connectors

For semi-rigid tubing

Male Luer, integral fixed lock ring

for 2.4 mm ID

MTLL420-6005

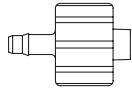

for 3.2 mm ID

MTLL430-6005

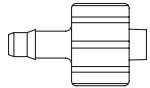

Female Luer

for 1.6 mm ID

FTLL410-6005

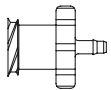

Panel mount fittings

Panel mount M5 mm (10-32 UNF thread)

Connector for 2.4 mm ID flexible tubing
PMK220-6005

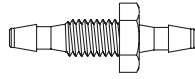

Lock nut, stainless steel, Hex 3/8" (10 mm)
PMKN-X0



Panel mount M6.5 mm (1/4-28 UNF thread)

Female Luer to 1.6 mm ID flexible tubing
FTLLB210-6005

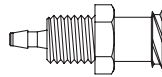

Connector for 3.2 mm ID flexible tubing
PMS230-6005

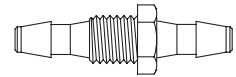

Female Luer to 3.2 mm ID flexible tubing
FTLLB230-6005

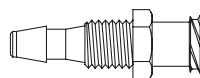

Lock nut, stainless steel, Hex 7/16" (11 mm)
PMSN-X0



Lock nut
LNS-1



Non-Threaded Panel Openings

Use any one of the three panel patterns shown below with a CCLR lock ring and LNS lock nut. For PMK-series the center hole diameter may be reduced to Ø 5 mm. Together, the panel opening and CCLR prevent the bulkhead fitting from rotating. Tighten LNS snug plus 1/4 turn only.

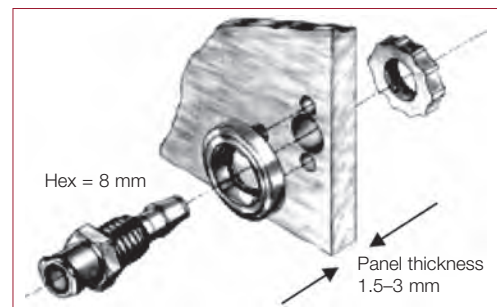

Panel mount luer shown with CCLR color coding ring, and LNS lock nut.

Threaded Panel Openings

Tap the panel with 1/4-28 UNF or 10-32 UNF thread and use a CCR color coded ring. In this case, the fitting tightened into panel prevents fitting rotation. Use an LNS lock but for additional security; tighten snug plus 1/4 turn only.

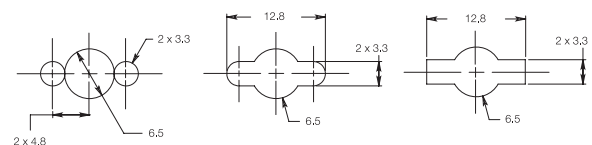

Dimensions in mm (for inch, multiply by 0.0394).

Threaded Fittings



M530.8



M631



10-32 UNF



10-32 Tapered



1/4"-28 UNF

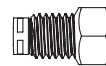

1/4"-28 UNF Bottom Sealed (rotating thread)

Port Design for secure and leak-free connection

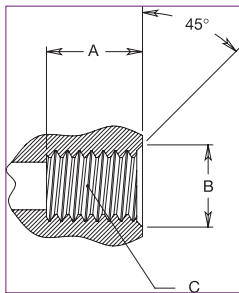

Fitting thread series	Dim. A Minimum full thread length	Dim. B Countersink diameter	C Internal screw thread
10-32 Taper	6.4 mm	5.3–5.8 mm	10-32 UNF 2B
10-32	5.1 mm	5.3–5.8 mm	10-32 UNF 2B
1/4-28 UNF	6.4 mm	6.8–7.3 mm	1/4-28 UNF 2B
M530.8	6.4 mm ¹	5.3–5.8 mm	M530.8
M631.0	9.6 mm ¹	6.8–7.3 mm	M631.0

¹ This depth provides clearance needed to provide chamfer seal.



1/16" NPT

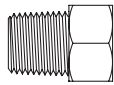

1/8" NPT

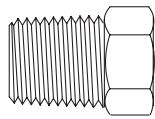

1/4" NPT

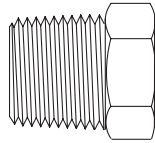

3/8" NPT

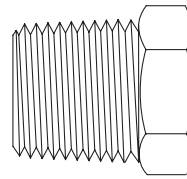

1/2" NPT

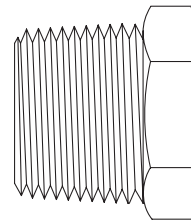

3/4" NPT

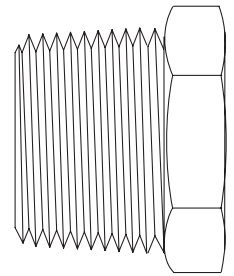

1" NPT



1/16" BSPT

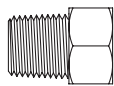

1/8" BSPT

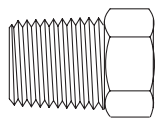

1/4" BSPT

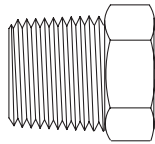

3/8" BSPT

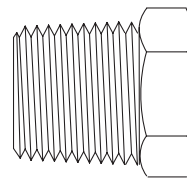

1/2" BSPT

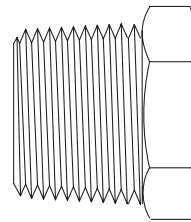

3/4" BSPT

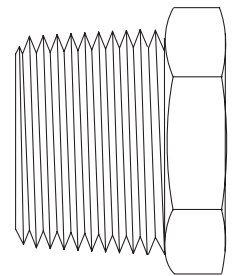

1" BSPT

Thread	M5	M6	10-32 UNF	10-32 Special Tapered	1/4"-18 NPT	1/16" NPT	1/8" NPT	1/8" BSPT	1/4" NPT
/ inch			32	32	28	27	27	28	18
Hex [mm]	6.5	8	6.5	6.5	8	8	11–12	11–12	15
								R 1/8"	

Thread	1/4" BSPT	3/8" NPT	3/8" BSPT	1/2" NPT	1/2" BSPT	3/4" NPT	3/4" BSPT	1" NPT	1" BSPT
/ inch	19	18	19	14	14	14	14	11.5	11
Hex [mm]	15	18	18	23	23	29	29	35	35
	R 1/4"		R 3/8"		R 1/2"		R 3/4"		R 1"

Threaded connectors

For flexible tubing

Straight connectors, thread to 1.6 mm ID

10-32 tapered
X210-6005
 1/4"-28 UNF Bottom Sealed
ABR004-6005-1

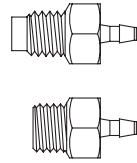

Straight connectors, thread to 2.4 mm ID

M6
M6220-6005

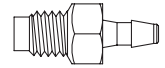

10-32 tapered
X220-6005
 1/4"-28 UNF
S220-6005
 1/4"-28 UNF Bottom Sealed
ABR007-6005-1

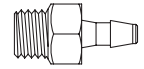

Straight connectors, thread to 3.2 mm ID

M6
M6230-6005

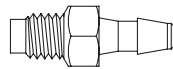

1/4"-28 UNF
S230-6005
 1/4"-28 UNF Bottom Sealed
ABR013-6005-1
 1/16"-27 NPT
16230-6005
 1/8"-27 NPT
18230-6005
 1/8" BSPT
A2B-2WP
 1/4" BSPT
A4B-2WP

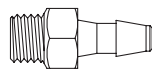

Straight connectors, thread to 4 mm ID

1/4"-28 UNF
S240-6005

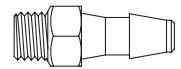

1/8"-27 NPT
18240-6005
 1/8" BSPT
A2B-2.5WP
 1/4" BSPT
A4B-2.5WP

Straight connectors, thread to 4.8 mm ID

1/4"-18 NPT
A4-3WP
 1/4" BSPT
A4B-3WP

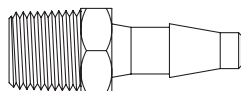

Straight connectors, thread to 6.4 mm ID

M1/4"-18 NPT
A4-4WP
 3/8"-18 NPT
A6-4WP
 1/2"-14 NPT
A8-4WP
 3/4"-14 NPT
A12-4WP
 1/8" BSPT
A2B-4WP
 1/4" BSPT
A4B-4WP
 3/8" BSPT
A6B-4WP

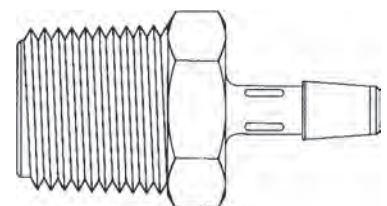
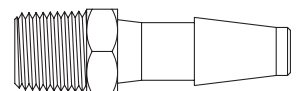

Threaded connectors

For flexible tubing

Straight connectors, thread to 8 mm ID

- 1/4"-18 NPT
- A4-5WP**
- 1/8"-27 NPT
- A2-5WP**
- 3/8"-18 NPT
- A6-5WP**
- 1/4" BSPT
- A4B-5WP**
- 3/8" BSPT
- A6B-5WP**

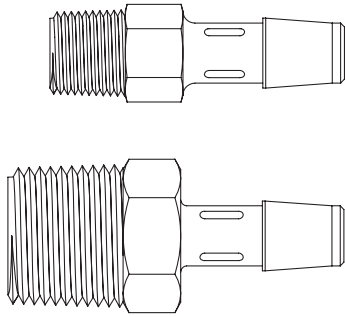

Straight connectors, thread to 9.6 mm ID

- 1/4"-18 NPT
- A4-6WP**
- 1/8"-27 NPT
- A2-6WP**
- 3/8"-18 NPT
- A6-6WP**
- 1/2"-14 NPT
- A8-6WP**
- 3/4"-14 NPT
- A12-6WP**
- 1/8" BSPT
- A2B-6WP**
- 1/4" BSPT
- A4B-6WP**
- 3/8" BSPT
- A6B-6WP**

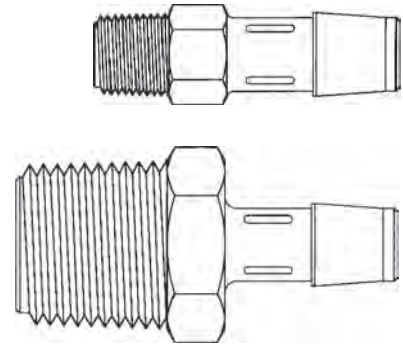

Straight connectors, thread to 12.7 mm ID

- 1/4"-18 NPT
- A4-8WP**
- 3/8"-18 NPT
- A6-8WP**
- 1/2"-14 NPT
- A8-8WP**
- 3/4"-14 NPT
- A12-8WP**
- 1/4" BSPT
- A4B-8WP**
- 3/8" BSPT
- A6B-8WP**

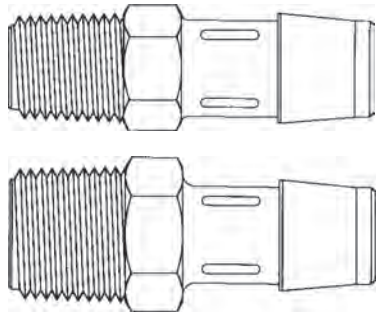

Straight connectors, thread to 16 mm ID

- 1/2"-14 NPT
- A8-10WP**
- 3/4"-14 NPT
- A12-10WP**

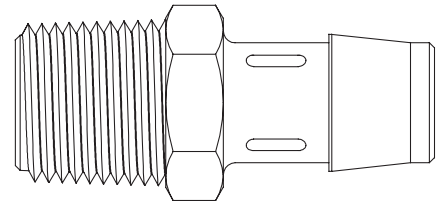

Straight connectors, thread to 19 mm ID

- 1/2"-14 NPT
- A8-12WP**
- 3/4"-14 NPT
- A12-12WP**

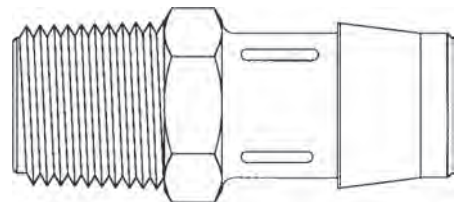

Straight connectors, thread to 25.4 mm ID

- 3/4"-14 NPT
- A12-16WP**
- 1"-11/2 NPT
- A16-16WP**

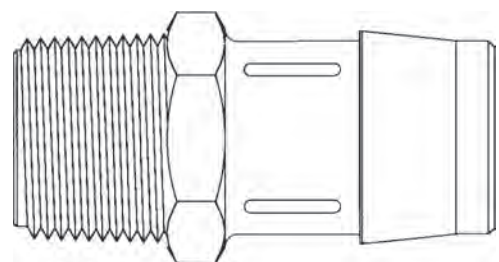

Threaded connectors

For flexible tubing

Elbow, thread to 1.6 mm ID

10-32 UNF
KL210-1
 10-32 tapered
XL210-6005



Elbow, thread to 3.2 mm ID

10-32 UNF
KL230-1
 1/8"-27 NPT
18L230-6005
 1/4"-18 NPT
L4-2WP
 1/8" BSPT
L2B-2WP
 1/4" BSPT
L4B-2WP

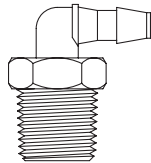

Elbow, thread to 4.8 mm ID

1/8"-27 NPT
18L250-6005
 1/4"-18 NPT
L4-3WP
 1/4" BSPT
L4B-3WP

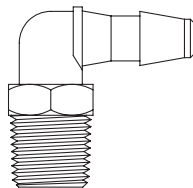

Elbow, thread to 8 mm ID

1/8"-27 NPT
L2-5WP
 1/4"-18 NPT
L4-5WP
 3/8"-18 NPT
L6-5WP
 1/8" BSPT
L2B-5WP
 1/4" BSPT
L4B-5WP
 3/8" BSPT
L6B-5WP

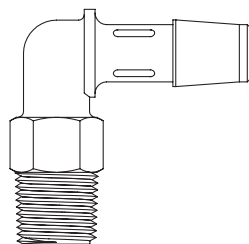

Elbow, thread to 4 mm ID

1/8"-27 NPT
L2-2.5WP
 1/4"-18 NPT
L4-2.5WP
 1/8" BSPT
L2B-2.5WP
 1/4" BSPT
L4B-2.5WP

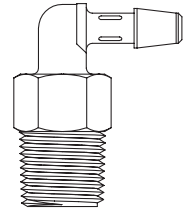

Elbow, thread to 6.4 mm ID

1/8"-27 NPT
18L260-6005
 1/4"-18 NPT
L4-4WP
 1/2"-14 NPT
L8-4WP
 3/4"-14 NPT
L12-4WP
 1/8" BSPT
L2B-4WP
 1/4" BSPT
L4B-4WP
 3/8" BSPT
L6B-4WP

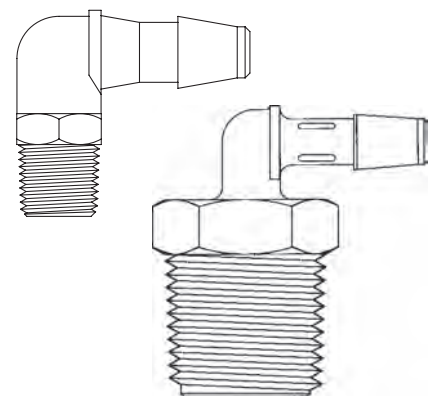

Elbow, thread to 9.6 mm ID

1/8"-27 NPT
L2-6WP
 1/4"-18 NPT
L4-6WP
 3/8"-18 NPT
L6-6WP
 1/2"-14 NPT
L8-6WP
 3/4"-14 NPT
L12-6WP
 1/8" BSPT
L2B-6WP
 1/4" BSPT
L4B-6WP
 3/8" BSPT
L6B-6WP

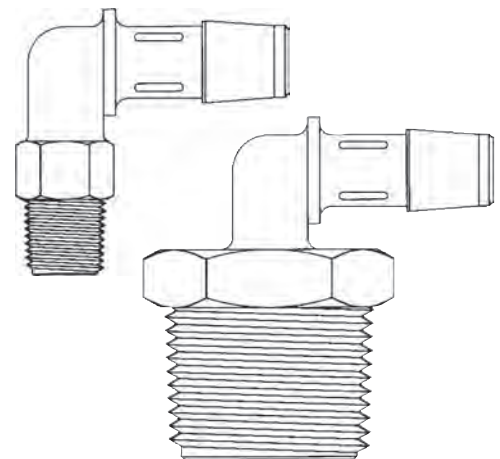

Threaded connectors

For flexible tubing

Elbow, thread to 12.7 mm ID

1/4"-18 NPT

L4-8WP

3/8"-18 NPT

L6-8WP

1/2"-14 NPT

L8-8WP

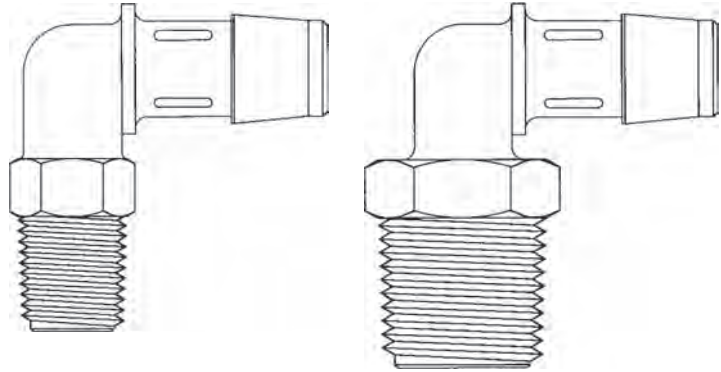

Elbow, thread to 16 mm ID

1/2"-14 NPT

L8-10WP

3/4"-14 NPT

L12-10WP

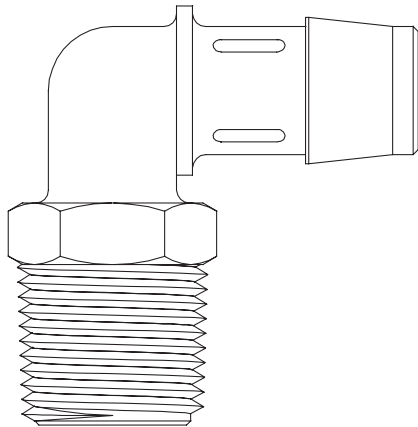

Elbow, thread to 19 mm ID

1/2"-14 NPT

L8-12WP

3/4"-14 NPT

L12-12WP

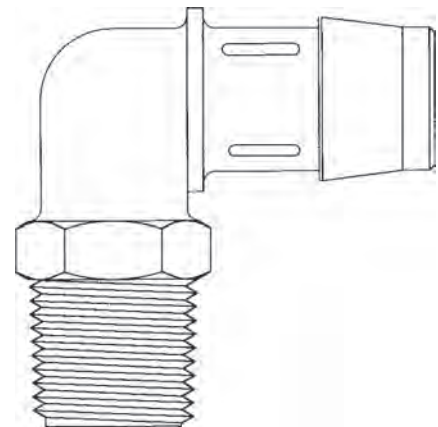

Elbow, thread to 25.4 mm ID

3/4"-14 NPT

L12-16WP

1"-1 1/2" NPT

L16-16WP

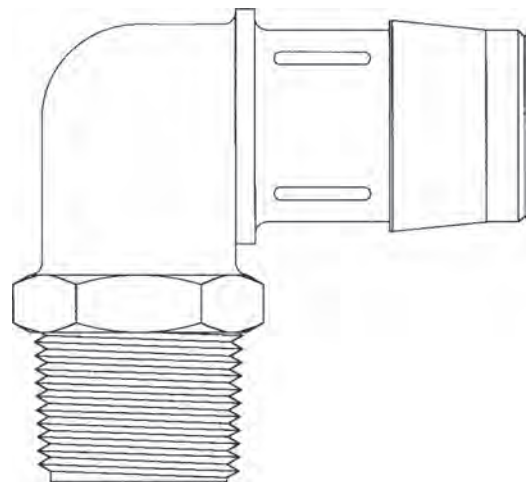

Threaded connectors

For flexible tubing

T-connector, thread to 4.8 mm ID

1/4"-18 NPT

T4-3WP

1/4" BSPT

T4B-3WP

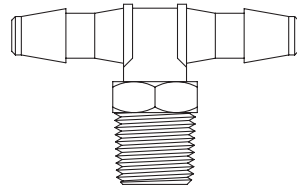

T-connector, thread to 6.4 mm ID

1/4"-18 NPT

T4-4WP

3/8"-18 NPT

T6-4WP

1/2"-14 NPT

T8-4WP

3/4"-14 NPT

T12-4WP

1/8" BSPT

T2B-4WP

1/4" BSPT

T4B-4WP

3/4" BSPT

T6B-4WP

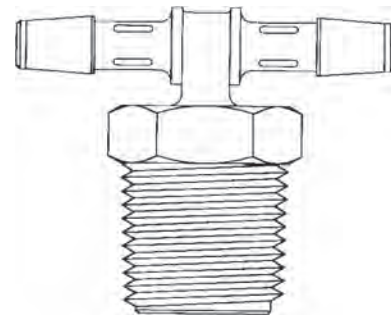
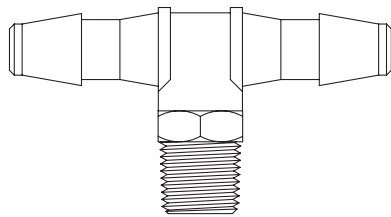

Threaded connectors

For flexible tubing

T-connector, thread to 8.0 mm ID

- 1/4"-18 NPT
T4-5WP
- 3/8"-18 NPT
T6-5WP
- 1/4" BSPT
T4B-5WP
- 3/8" BSPT
T6B-5WP

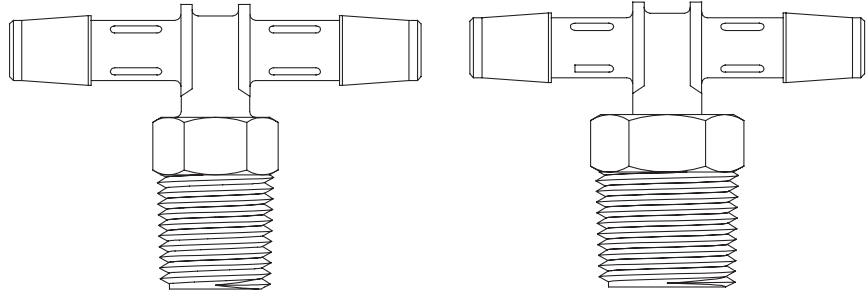

T-connector, thread to 9.6 mm ID

- 1/8"-27 NPT
T2-6WP
- 1/4"-18 NPT
T4-6WP
- 3/8"-18 NPT
T6-6WP
- 1/2"-14 NPT
T8-6WP
- 3/4"-14 NPT
T12-6WP
- 1/8" BSPT
T2B-6WP
- 1/4" BSPT
T4B-6WP
- 3/8" BSPT
T6B-6WP

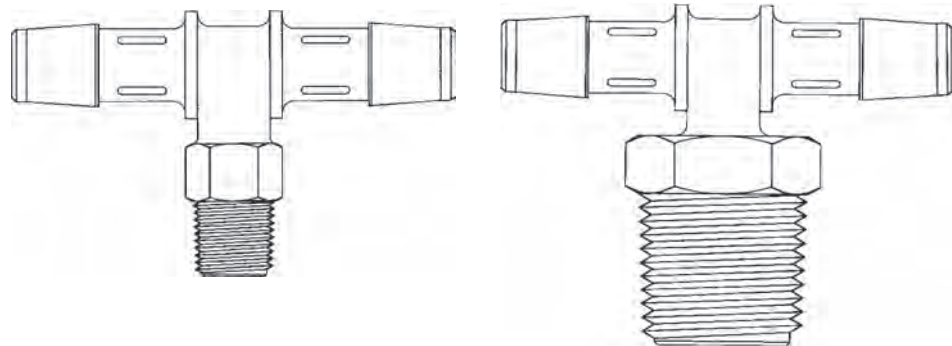

T-connector, thread to 12.7 mm ID

- 1/4"-18 NPT
T4-8WP
- 3/8"-18 NPT
T6-8WP
- 1/2"-14 NPT
T8-8WP
- 3/4"-14 NPT
T12-8WP
- 1/4" BSPT
T4B-8WP
- 3/8" BSPT
T6B-8WP

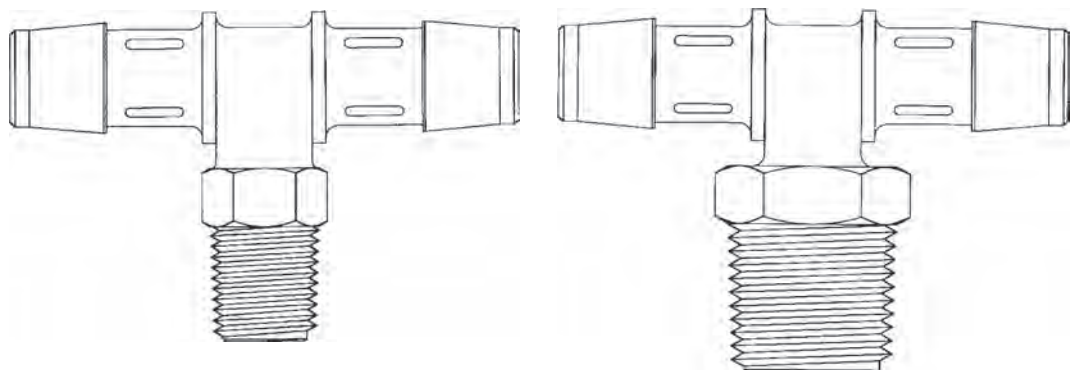

Threaded connectors

For flexible tubing

T-connector, thread to 19.2 mm ID

1/4"-18 NPT
T8-12WP
3/4"-14 NPT
T12-12WP

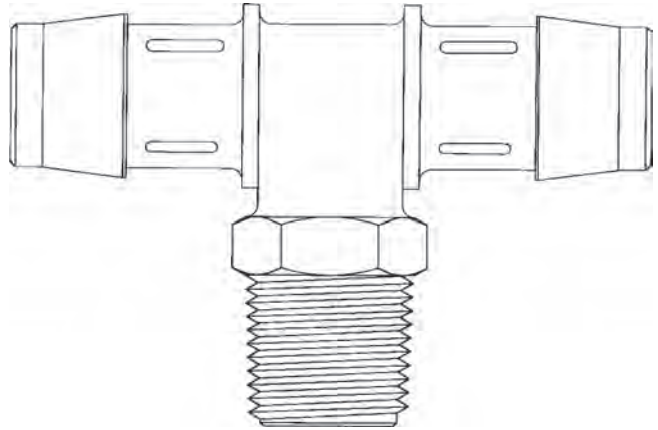

T-connector, thread to 25.4 mm ID

3/4"-14 NPT
T12-16WP
1"-11 1/2" NPT
T16-16WP

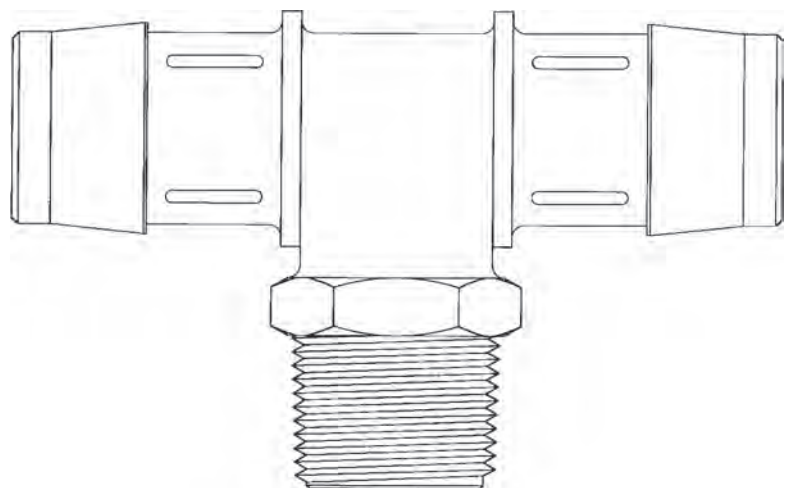

Threaded Plugs

1/4"-28 UNF
SP-6005

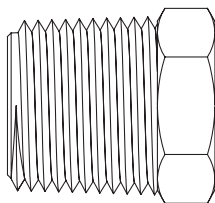

Threaded connectors

For semi-rigid tubing

Straight connector, thread to 2.4 mm ID

10-32 UNF
K420-6005

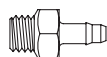

Barb design

Each barb is designed to combine minimum flow restriction, pressure capability, hold and ease of assembly for a given range of tube sizes and tube materials. Together with the recommendations below the fitting range of this catalogue provides solutions to most applications.

However, if your requirements can not be met with the range in this catalogue it is likely that we can offer a similar fitting with an alternate barb design.

Pressure Capability

The single-barb design enables the tubing to relax behind the barb creating a perfect seal with minimal risk for leakage. The tube is extended over the barb – higher extension is required for more flexible tubing and for handling higher pressure. For the smaller tube bore fittings an over size fitting can be considered to improve the pressure capability. For larger tube bores a clamp can be necessary, see picture below.

Hold

For example in a peristaltic pump or whenever tension is applied to the tube it has to be prevented from slipping off the fitting. For the smaller tube bore fittings an over size fitting can be considered. For larger tube bores a clamp can be necessary, see picture below.

Alternatively, a simple plastic cable tie can be used.

Ease of Assembly

Standard barbs for semi rigid tubing expand the tubing 25% above its nominal inner diameter and barbs for flexible tubing expand 40-60%. Barb for semi-rigid tubing can be used also for flexible tubing when tensile/pressure properties are not highly critical but ease of assembly is.

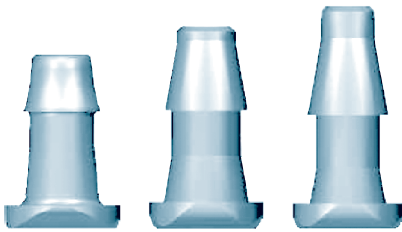

Barb styles for Flexible tubing



...and for Semi-Rigid

Proper clamp placement for barbed fittings

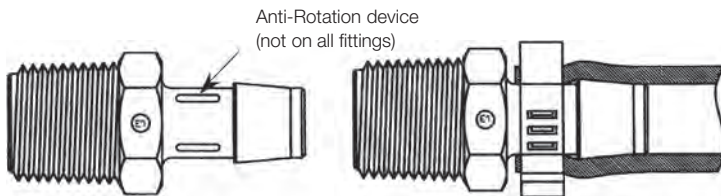

Never place a clamp over the large diameter of the barb. Clamps work best when tightened into the recess behind the barb. For best results place the clamp behind the barb and over the anti-rotation devices.

Benefits with single barb design

Single-barb

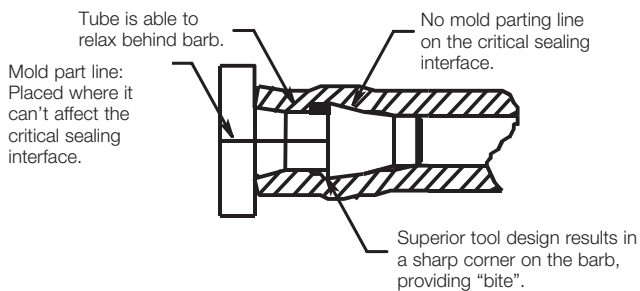

Multi-barb

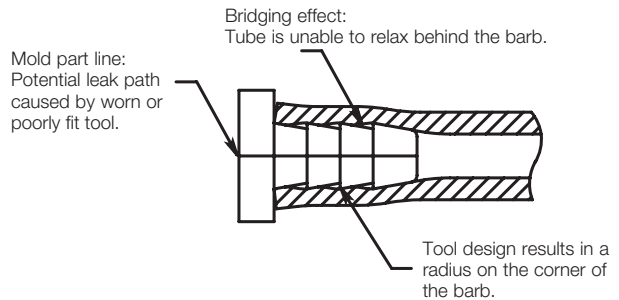

Fitting materials

Guideline information about chemical compatibility and sterilization resistance for common resins.

Kynar®

Poly Vinylidene Fluoride or PVDF, is physically strong, damage resistant, and resistant to multiple radiation autoclave sterilization cycles. In spite of its initially higher cost in comparison with many other materials, its durability and long-term use potential under harsh conditions makes it cost-effective.

Nylon

Poly Amide, PA, combines strength, moderate stiffness, high service temperature, and toughness. Nylon resist fuels, lubricants and many chemicals, but are attacked by phenols, strong acids and oxidizing agents. Acceptable sterilization methods include Ethylene Oxide or Autoclave, see sterilization chart for details. Nylon is available in different colours.

Polypropylene

PP, is highly resistant to solvents and chemicals. It has outstanding resistance to water and other inorganic environments. It resists most strong mineral acids and bases, but, like other polyolefins, it is subject to attack by oxidizing agents. Polypropylene has excellent resistance to environmental stress-cracking. Acceptable sterilization methods include Gamma Radiation and Ethylene Oxide, see sterilization chart for details.

Polycarbonate

PC, is a clear and colourless resin. Outstanding properties include impact strength and scratch resistance. Polycarbonate resists weak acids, animal and vegetable oils and greases but is attacked by oxidizing agents and hot water. Acceptable sterilization methods are gamma radiation and ethylene oxide.

ABS

Acrylonitrile Butadiene Styrene, has good mechanical properties even at low temperatures. ABS is chemically resistant to many acids and bases. Acceptable sterilization methods are gamma radiation and ethylene oxide, see sterilization chart for details.

Fitting materials

Sterilization

	GAMMA RADIATION	ETHYLENE OXIDE	AUTOCLAVE
Kynar®	Highly compatible, but will discolor to brownish hue. Physical Properties typically improve.	Excellent	Excellent
Polycarbonate	Compatible to 10 M-Rad dose with little loss of physical properties. Will discolor to light yellow-green hue.	Highly compatible with 100% EtO; may stress crack if sterilized in EtO/ CFC mix, due to molding stresses.	Not recommended. May craze or stress crack due to molding stresses.
Radiation Stable Polycarbonate	Excellent up to 10 M-Rad dose with little loss of physical properties. Light violet hue turns clear upon sterilization.	Highly compatible. Withstands normal EtO sterilization conditions, but multiple exposures can reduce tensile elongation properties.	Not recommended.
Polypropylene	Excellent up to commonly used sterilization doses (approximately 6 M-Rad).	Fair; may stress crack in EtO/ CFC mix due to molding stresses.	Poor. Parts may distort due to low heat deflection temperature.
Nylon and Glass Filled Nylon	Physically compatible with commonly used sterilization doses, but may discolor to brownish hue.	Very Good. Some susceptibility to oxidizing agents.	Very Good. Components may swell slightly due to water absorption.
ABS	Compatible to 10 M-Rad dose with some loss of impact strength, but increased tensile strength. Some discoloration to slight brownish hue.	Excellent retention of properties for at least 5 sterilization cycles.	Poor. Parts may distort due to low heat deflection temperature.

Mechanical Properties

	E-Modulus, GPa	Elongation at break, %	Tensile yield strength, MPa	Izod Impact Notched, J/m	Water % _{24h} absorption,	Density, kg/dm ³
Test Method	DIN 53 457	DIN 53 452	DIN 53 455	ASTM D256	ASTM D510	
ABS	2.1	25	45	85	0.4	1.05
Kynar®	0.8		40	166	0.015	1.76
Nylon	2	200	80	53	1.2	1.14
Polycarbonate	2.3	100	70	> 800	0.15	1.2
Polypropylene	1.5	500	37	69	0	0.9

The data presented in this section is for reference only. It was compiled primarily by the resin manufacturers to provide customers with a means of comparing the characteristics of resins used at the time of publication. The particular conditions of your use and application of our products are beyond our control. Thus, it is imperative that you test our products in your specific application to determine their suitability. All information is provided without implied or expressed warranty or guarantee by W-M Alitea AB, or the resin manufacturers. None of the information provided constitutes a recommendation or endorsement of any kind by W-M Alitea AB. In critical applications please contact W-M Alitea for more information and product certifications. Note, all fittings are not available in all materials. Kynar® is a registered trademark of Atochem North America, Inc.

Resin Regulatory Status

The last 1–4 characters of the product code tell the specific resin of the fitting.

Description	Product code ending with:	Resin regulatory status
ABS, White	8012	USP Classification VI, ISO10993 P.1
Kynar (PVDF), Natural*	J2A	USP Classification VI, FDA 21 CFR 177.2510/177.1520
Kynar (PVDF), Natural*	NK7	USP Classification VI, NSF Standards 61, FDA 21 CFR 177.2510
Nylon, Black	2	FDA 21 CFR 177.1500
Nylon, Black	BN	
Nylon, Black, Glass Filled	GFBN	
Nylon, Blue	5	FDA 21 CFR 177.1500
Nylon, Green	4	FDA 21 CFR 177.1500
Nylon, Natural	NN	FDA 21 CFR 177.1550
Nylon, Natural	0	FDA 21 CFR 177.1500
Nylon, Orange	06	FDA 21 CFR 177.1500
Nylon, Red	3	FDA 21 CFR 177.1500
Nylon, White	1	FDA 21 CFR 177.1500
Nylon, White	WN	
Nylon, Yellow	07	FDA 21 CFR 177.1500
Polycarbonate	9	USP Classification VI, FDA 21 CFR 177.1580, ISO 10993
Polycarbonate, Rad. Stable	9002	USP Classification VI, ISO 10993
Polyethylene, High Density	HDPE	FDA 21 CFR 177.1520
Polypropylene, Black	62	
Polypropylene, Natural*	6005	USP Classification VI, FDA 21 CFR 177.1520
Polypropylene, Natural*	PP	USP Classification VI, FDA 21 CFR 177.1520
Polypropylene, White	WP	
Stainless Steel	X0	

*Animal Derivative Free

Product Certification

For classified products, Product Certification documents are provided upon request, free of charge. The Product Certification document references all relevant purchase order, customer order and material lot information. Natural Kynar and Natural Polypropylene materials are Animal Derivative Free.

All resins are RoHs compliant. All resins except white polypropylene are also DEHP free. White polypropylene may contain small amounts of phalates.

The list of SVHC's is updated regularly. The status of SVHC and REACH is available from your distributor.

Chemical compatibility chart

Price index*			0.9	2 – 4	0.9	1.1	1
Chemical	Concent.	Temp °C	ABS	Kynar®	Nylon	Polycarb.	Polyprop.
Acetic Acid	5%	23 °C	Excellent	Excellent	Satisfactory	Satisfactory	Excellent
Acetone	100%	50 °C	Satisfactory	Unsatisfactory	Satisfactory	Unsatisfactory	Excellent
Acetophenone	100%	24 °C	Satisfactory	Unsatisfactory	Excellent	Satisfactory	
Acetylene	100%	24 °C		Excellent	Excellent		
Air	100%	82 °C	Excellent	Excellent	Excellent		
Ammonia, Liquid	100%	24 °C	Satisfactory	Unsatisfactory	Satisfactory	Unsatisfactory	Excellent
Ammonium Hydroxide	10%	23 °C	Satisfactory	Excellent	Excellent	Unsatisfactory	Excellent
Ammonium Hydroxide	10%	70 °C	Unsatisfactory	Excellent	Unsatisfactory	Unsatisfactory	Excellent
Barium Sulfide	100%	24 °C	Excellent	Excellent	Satisfactory		Excellent
Benzene	100%	23 °C	Satisfactory	Excellent	Excellent	Unsatisfactory	Satisfactory
Bleach	100%	23 °C	Satisfactory	Excellent	Satisfactory	Unsatisfactory	Satisfactory
Boric Acid	7%	35 °C	Excellent	Excellent	Unsatisfactory	Excellent	Excellent
Calcium Carbonate	Sat. sol.	24 °C	Excellent	Excellent			Excellent
Carbon Dioxide	100%	50 °C	Satisfactory	Excellent	Excellent		Excellent
Carbon Monoxide	100%	50 °C	Satisfactory	Excellent	Excellent		Excellent
Carbon Tetrachloride	100%	50 °C	Unsatisfactory	Excellent	Excellent	Unsatisfactory	Unsatisfactory
Chlorine Water	Dilute	23 °C	Unsatisfactory	Excellent	Satisfactory	Unsatisfactory	Unsatisfactory
Chlorine Water	Concent.	23 °C	Unsatisfactory	Excellent	Unsatisfactory	Unsatisfactory	Unsatisfactory
Chlorobenzene	100%	23 °C	Satisfactory	Excellent	Excellent	Unsatisfactory	Unsatisfactory
Chlorofluorocarbon 11	100%	24 °C		Excellent	Excellent	Satisfactory	
Chloroform	100%	23 °C	Unsatisfactory	Excellent	Satisfactory	Unsatisfactory	Unsatisfactory
Cyclohexanone	100%	24 °C	Satisfactory	Excellent	Excellent	Unsatisfactory	Satisfactory
Dichlorethylene	100%	23 °C		Excellent	Satisfactory		Excellent
Ethanol	95%	50 °C	Satisfactory	Excellent	Excellent	Satisfactory	Excellent
Ethyl Acetate	95%	50 °C	Satisfactory	Unsatisfactory	Excellent	Unsatisfactory	Satisfactory
Ethylene Glycol	100%	23 °C	Excellent	Excellent	Excellent	Satisfactory	Excellent
Ethylene Oxide	100%	24 °C	Unsatisfactory	Excellent	Satisfactory	Satisfactory	Satisfactory
Ethylene Oxide	100%	79 °C	Unsatisfactory	Excellent	Unsatisfactory	Satisfactory	Unsatisfactory
Fatty Acids	-			Excellent			Excellent
Fluorine	100%	23 °C	Unsatisfactory	Excellent	Unsatisfactory		
Formaldehyde	37%	24 °C	Unsatisfactory	Excellent		Unsatisfactory	Excellent
Gasoline	100%	85 °C	Excellent	Excellent	Excellent	Unsatisfactory	Satisfactory
Glucose	Concent.	24 °C	Excellent	Excellent			Excellent
Glycerin	100%	24 °C	Excellent	Excellent		Excellent	Excellent
Hydrochloric Acid	2%	23 °C	Excellent	Excellent	Excellent	Excellent	Excellent
Hydrochloric Acid	10%	25 °C	Excellent	Excellent	Unsatisfactory	Excellent	Excellent
Hydrochloric Acid	10%	23 °C	Satisfactory	Excellent	Unsatisfactory		Excellent
Hydrogen Peroxide	1%	24 °C	Excellent	Excellent	Satisfactory	Excellent	Excellent
Hydrogen Peroxide	5%	43 °C	Satisfactory	Excellent	Unsatisfactory	Excellent	Satisfactory
Isopropanol	100%	23 °C	Excellent	Excellent	Excellent	Excellent	Excellent
Kerosene	100%	85 °C	Satisfactory	Excellent	Excellent	Satisfactory	Satisfactory
Methanol	100%	23 °C	Unsatisfactory	Excellent	Excellent	Satisfactory	Excellent
Methyl Ethyl Ketone	100%	50 °C	Satisfactory	Unsatisfactory	Excellent	Unsatisfactory	Satisfactory
Methylene Chloride	100%	23 °C	Unsatisfactory	Excellent	Satisfactory	Unsatisfactory	Excellent
Nitric Acid	10%	23 °C	Satisfactory	Excellent	Unsatisfactory	Unsatisfactory	Excellent
Oxygen	100%	24 °C		Excellent	Satisfactory		
Ozone	100%	43 °C	Satisfactory	Excellent	Unsatisfactory	Unsatisfactory	
Phenol	90%	23 °C	Unsatisfactory	Excellent	Unsatisfactory		Excellent
Phosphoric Acid	5%	98 °C	Satisfactory	Excellent	Unsatisfactory	Unsatisfactory	Excellent
Propane	100%	23 °C	Satisfactory	Excellent	Excellent		
Sodium Bicarbonate	Concent.	24 °C	Excellent	Excellent	Excellent		Excellent
Sodium Chloride	10%	23 °C	Excellent	Excellent	Excellent		Excellent
Sodium Chloride	Sat. sol.	24 °C	Excellent	Excellent	Excellent		Excellent
Sodium Hydroxide	10%	70 °C	Satisfactory	Excellent	Satisfactory		Excellent
Steam	-	120 °C	Unsatisfactory	Excellent	Unsatisfactory	Unsatisfactory	Satisfactory
Sulfuric Acid	30%	23 °C	Satisfactory	Excellent	Unsatisfactory	Excellent	Excellent
Tetrahydrofuran	100%	23 °C	Satisfactory	Unsatisfactory	Excellent		Unsatisfactory
Toluene	100%	50 °C	Satisfactory	Excellent	Excellent	Unsatisfactory	Unsatisfactory
Trichloroethylene	100%	23 °C	Satisfactory	Excellent	Satisfactory	Unsatisfactory	Unsatisfactory
Water	100%	79 °C	Excellent	Excellent	Excellent	Unsatisfactory	Excellent

The data presented here is for reference only. It was compiled primarily by the resin manufacturers to provide our customers with a means of comparing the characteristics of resins used. The particular conditions of your use and application of our products are beyond our control. Thus, it is imperative that you test our products in your specific application to determine their suitability. All information is provided without implied or expressed warranty or guarantee by W-M Alitea AB. None of the information provided constitutes a recommendation or endorsement of any kind by W-M Alitea AB.

* Price index should only be seen as a guidance. Prices will differ for different products. Note, all fittings are not available in all materials.



Fluid
Technology
Solutions

BIOTECHNOLOGY AND PHARMACEUTICAL SOLUTIONS



Watson-Marlow Fluid Technology Solutions

Watson-Marlow Fluid Technology Solutions supports its customers locally through an extensive global network of direct sales operations and distributors

wmfts.com/global

