

504Du



Contents

Declarations	3
Three year warranty	3
Information for returning pumps	3
Recommended operating procedures	3
Installation	4
Rear panel recess	4
Reduced voltage operation	5
Troubleshooting	5
User interfacing	5
Manual operation	5
Auto	6
Calibration procedure	7
Setup	7
Remote control	8
Care and maintenance	9
Specification	10
501RL pumphead	10
Flow rates	10
501RL installation	10
Tube loading	11
Roller adjustment	11
501RL Pumphead spares	12
Drive spares	13
Outline dimensions 504Du/RL	14
Technical data	15
Product Use and Decontamination Certificate	30

Declarations

Declaration of conformity 	When this pump unit is used as a stand alone pump it complies with: Machinery Directive 89/392/EEC EN60204-1, Low Voltage Directive 73/23/EEC EN61010-1, EMC Directive 89/336/EEC EN50081-1/EN50082-1.
---	---

Declaration of Incorporation	When this pump unit is to be installed into a machine or is to be assembled with other machines for installations, it must not be put into service until the relevant machinery has been declared in conformity with the Machinery Directive 89/392/EEC EN60204-1.
-------------------------------------	---

Responsible person: Dr R Woods, Managing Director, Watson-Marlow Limited, Falmouth, Cornwall TR11 4RU, England.
Telephone 01326 370370 Fax 01326 376009.



Three year warranty

Watson-Marlow Limited warrants, subject to the conditions below, through either Watson-Marlow Limited, its subsidiaries, or its authorised distributors, to repair or replace free of charge, including labour, any part of this product which fails within three years of delivery of the product to the end user. Such failure must have occurred because of defect in material or workmanship and not as a result of operation of the product other than in accordance with the instructions given in this manual.

Conditions of and specific exceptions to the above warranty are:

- Consumable items such as tubing and rollers are excluded.
- Products must be returned by pre-arrangement carriage paid to Watson-Marlow Limited, its subsidiaries, or its authorised distributor.
- All repairs or modifications must have been made by Watson-Marlow Limited, its subsidiaries, or its authorised distributors or with the express permission of Watson-Marlow Limited, its subsidiaries, or its authorised distributors.
- Products which have been abused, misused, or subjected to malicious or accidental damage or electrical surge are excluded.

Warranties purporting to be on behalf of Watson-Marlow Limited made by any person, including representatives of Watson-Marlow Limited, its subsidiaries, or its distributors, which do not accord with the terms of this warranty shall not be binding upon Watson-Marlow Limited unless expressly approved in writing by a Director or Manager of Watson-Marlow Limited.

Information for returning pumps

Equipment which has been contaminated with, or exposed to, body fluids, toxic chemicals or any other substance hazardous to health must be decontaminated before it is returned to Watson-Marlow or its distributor.



A certificate included at the rear of these operating instructions, or signed statement, must be attached to the outside of the shipping carton.

This certificate is required even if the pump is unused. If the pump has been used, the fluids that have been in contact with the pump and the cleaning procedure must be specified along with a statement that the equipment has been decontaminated.

Safety

In the interests of safety, this pump and the tubing selected should only be used by competent, suitably trained personnel after they have read and understood this manual, and considered any hazard involved.

Any person who is involved in the installation or maintenance of this equipment should be fully competent to carry out the work. In the UK this person should also be familiar with the Health and Safety at Work Act 1974.

 	There are dangerous voltages (at mains potential) inside the pump. If access is required, isolate the pump from the mains before removing the cover.
--	---

Recommended operating procedures

- DO** keep delivery and suction lines as short as possible using a minimum number of swept bends.
- DO** use suction and delivery pipelines with a bore equal to or larger than the bore of the tube fitted in the pumphead. When pumping **viscous** fluids, the losses caused by increased friction can be overcome by using pipe runs with a cross sectional area several times greater than the pumping element.

DO run at a slow speed when pumping viscous fluids. When using the 501RL pumphead, a 4.8 or 6.4mm bore tube with a 1.6mm wall will give best results. Tube diameter smaller than this will generate a high-friction pressure loss, so reducing the flow. Tube with a larger bore will not have sufficient strength to resist. Flooded suction will enhance pumping performance in all cases, particularly for materials of a viscous nature. Silicone, Marprene and Neoprene tubing is available with a 2.4mm wall thickness for speeds up to 200rpm. (The rotor will require re-setting to a roller/track gap of 3.8mm).

DO fit an extra length of pump tube in the system to enable tube transfer. This will extend tube life and minimise the downtime of the pumping circuit.

DO keep the track and rollers clean.

The self-priming nature of peristaltic pumps means valves are not required. Any valves fitted must cause no restriction to flow in the pumping circuit.

When using Marprene tubing, after the first 30 minutes of running, re-tension the tube in the pumphead by releasing the tube clamp on the delivery side a little and pulling the tube tight. This is to counteract the normal stretching that occurs with Marprene which can go unnoticed and result in poor tube life.

Tube selection The chemical compatibility list published in the Watson- Marlow catalogue is only a guide. If in doubt about the compatibility of a tube material and the duty fluid, request a tube sample card for immersion trials.

Installation

The 504Du is suitable for single phase mains electricity supplies only.

To ensure correct lubrication of the gearbox the pump should be run only while its feet are standing on a horizontal surface. The pump should be positioned to allow a free flow of air around it.

- Remove the small transparent plate on the rear panel to gain access to the voltage selector and terminal block.
- Set the voltage selector to either 120V for 100-120V 50/60Hz single phase AC supplies or 240V for 220-240V 50/60Hz single phase AC supplies.
- Route the mains supply cable through the entry point to the right of the recess, and couple the cable to the terminal block as shown on the rear panel.
- There are two alternative connectors. One accepts 20mm rigid or flexible conduit, and the other accepts three core 0.75 square millimetre PVC sheathed mains cable (via the screwed adaptor supplied) so that a mains lead can be used.
- Ensure that the mains lead is securely retained in the strain relief gland so that IP55 ingress protection is maintained.
- Securely replace the transparent plate and the gasket over the recess.

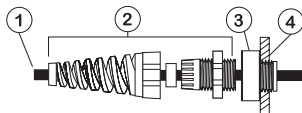

- 1 Strain relief gland SL 0020
- 2 Adaptor MR0678T
- 3 Washer GR 0019
- 4 M20 Conduit thread for direct conduit connection, through back panel



Ingress protection standard will be compromised if the transparent plate is not replaced.

Rear panel recess

The pump rear panel recess houses the following:

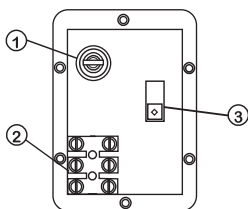

- 1 Fuse holder
- 2 Terminal block
- 3 Voltage selection switch

Reduced voltage operation

In areas where voltage is below that specified above, modifications can be made to the pump unit to allow operation under the following minimum voltage levels:

- 180V when using the 220-240V setting
- 90V when using the 100-120V setting

The modification requires the connector J18 on the **Control PCB** to be reversed. To locate the terminal, isolate the mains supply then remove the pump cover. **State A** shows the standard voltage setting, whilst **State B** shows the reduced voltage setting. Any damage caused to the pump in the process of carrying out this modification will not be covered by warranty.

Control PCB

State A

State B

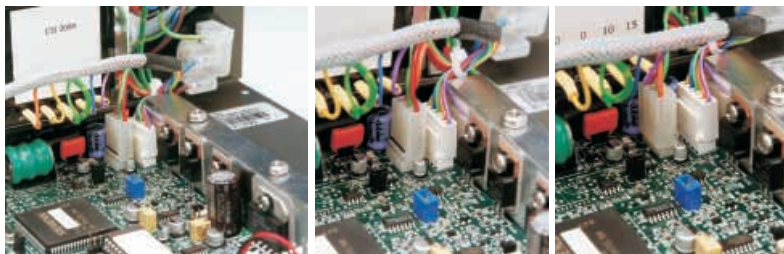

Refer servicing to qualified personnel only.

Troubleshooting

Should the pump fail to operate, make the following checks to determine whether or not servicing is required.

- Check that the power switch is on.
- Check the mains supply is available at the pump.
- Check the voltage selector switch is in the correct position.
- Check the fuse in the mains socket.
- Check that the pump is not stalled by incorrect fitting of tubing.
- Check that the keypad lock is not switched on.

User interfacing

When powering up the pump the user will be taken into the main menu.

Use the **Step** key to move between menu options. Use the **Enter** key to confirm settings. Use the number keys to enter in settings. Use the **▲** or **▼** key to increase or decrease set values in the pump software i.e. ramp settings, date, rpm etc.

Manual allows continuous transfer/fluid metering via keypad control.

Auto enables analogue (process signal speed control) or RS232 control.

Calib allows the pump to be calibrated for accurate dosing.

Set-up displays and controls the user and factory settings for the correct operation of the pump.

The speed/volume flow rate of the drive is governed by the pumphead and tubing selected. Factory default is for a 501RL using 8.0mm bore tubing which means the max rpm/volume flow rate of the pump is 220 rpm/2200ml/min.

Manual operation

- Switch power on (drive rear panel).
- Change the set speed by pressing the **▲** or **▼** key. The 504Du speed control ratio is 220:1. This will give a minimum speed of 1rpm for the 220rpm drive and 0.5 rpm for the 55rpm drive.
- Change direction by pressing the **CW/CCW** key. Check the flashing **CW/CCW** symbol for actual direction setting. (**CW**: clockwise **CCW**: counterclockwise).

- Select the maximum speed: press the **▲** key and the **Max** key together. Select the minimum speed: press the **▼** key and the **Max** key together.
- The keypad has a locking facility to avoid resetting or tampering. If the pump is stopped, press **Stop** until the padlock symbol illuminates. If the pump is running, press **Start** until the padlock symbol illuminates. All keys will be disabled except for **Start** and **Stop**. Press these keys until the padlock symbol extinguishes to unlock the keypad.
- The pump can be set to automatically restart in its operating state set prior to interruption, or set so that after power is reconnected the pump will remain stopped. To invoke the Auto-restart facility switch off power to the pump at the mains supply. Press the **Start** key down when the mains supply is switched back on until the **!** symbol illuminates. Now press **Start** to start the pump. This facility can be cancelled by turning the mains supply off and then pressing the **Stop** key whilst turning the mains supply back on. The **!** symbol will not be illuminated.
- Press **Start** to start the pump. Press **Stop** to stop the pump.

Auto

The pump will accept external control signals through the 25 pin terminal strip on the back panel. Remove the cover plate ensuring that the gasket is not damaged. Feed the control wires through the cable glands and connect via the spring cage clamps.

Analogue

This function enables the pump speed to be controlled via an external analogue process signal. Pressing Enter at analogue will call a confirmation of the analogue control signal settings. These can be reset under Setup (see section covering pump setup).

RS232

This facility gives full pump functionality under RS232 closed loop control via the 4 pin terminal strip. Up to 16 pumps can be linked whilst still retaining individual pump control by using lead PR 0024. A network kit is available from Watson-Marlow which includes Pumpnet 2, a DOS compatible control program and leads.

Step to Network in the Main menu and press **Enter**. The pump will now be under RS232 control. The keypad **Stop** key will act as an emergency stop and disable RS232 settings if pressed.



Connections for RS232 signals, 1 = GND, 2= RX, 3 = TX, 4 = CTS

RS232 cabling shown for CTR handshake

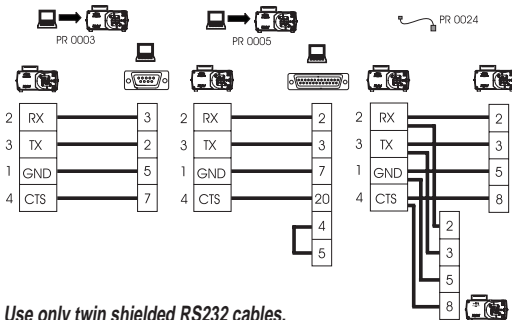

Use only twin shielded RS232 cables.

RS232 settings

Baud = 9600 ; Stop bits = 2 ; Data bits = 8 ; Parity = None ; Handshake = CTR or None ; Auto echo = On

The following codes may be used to operate the 504Du under RS232C control. They must be directed to the pump from a computer serial port (or equivalent). Always terminate each command with a RETURN (ASCII CHR13).

nSPxxx	Load speed setting xxx to pump number n
nSI	Increment speed by 1rpm for pump n
nSD	Decrement speed by 1rpm for pump n
nGO	Start pump number n

nST	Stop pump number n
nRC	Change rotation direction for pump n
nRR	Set clockwise direction for pump n
nRL	Set anti-clockwise direction for pump n
nDOxxxxx,yyy	Set dose for pump number n in tachometer pulses (note 3)
nRS	Show status for pump number n (note 4)
nZY	Show status if pump n STARTed 1 or STOPped 0
nTC	Clear tachometer counter
nRT	Read tachometer counter

For writing to pump number n display

nCA	Clear existing display; followed by:
nCH	"Home" cursor; followed by;
nW{text line 1}~{text line 2}@	(@ = terminator)

Notes on control codes

- 1 n = pump number set in **Setup**. For the command to operate on all networked pumps simultaneously, use # before the command.
- 2 There are 1280 tacho pulse per revolution on the 220rpm version and 3200 tacho pulse per revolution on the 55rpm version.
- 3 nDOxxxxxxx where xxxxxxxx is any integer and is the target dose in tacho pulses. This can be extended to nDOxxxxxxx,yyy where yyy is a "kick back" in tacho pulses with a limit of 255 (about 1/12 of a revolution on a 55rpm drive or a 1/5 of a revolution on the 220rpm drive).
- 4 A show status command will prompt the 504Du to return a text string of the following layout:
 [pump type] [ml/rev] [pumphead] [tube size] [speed] [cw/ccw] [P/N] [pump number] [tacho count as a single integer] [stopped/running, 0/1] [! = delimiter]
 eg 504Du 0.7 505l 1.6mm 53.5 CW P/N 1 157810 1 !
- 5 All networked pumps with the same n will respond to the same command.
- 6 There should be at least 10mS between consecutive commands
- 7 When using the # to address all pumps, ensure that it will not generate a *reply*, eg nSS, the result will be unpredictable.

This is a typical short program for pump number 2:

```
OPEN "COM1:9600,N,8,2,CDO,CSO,DSO,OP10000" FOR RANDOM AS #1
PRINT #1, "2SP220" + CHR$(13)
DELAY (command depends on language being used)
PRINT #1, "2GO" + CHR$(13)
DELAY 5000
PRINT #1, "2ST" + CHR$(13)
CLOSE #1.
```

Calibration procedure

Calibration of the 504Du is based on informing the pump under Set-up of the pumphead and tubing which are to be used. Alternatively a calibration dose can be used. The calibration dose will run for a maximum of 4 minutes, but can be stopped at any time up to 4 minutes. The longer the calibration dose the more accurate the calibration. Entering into the pump the physical volume (ml) or mass (sg) to complete the procedure and will allow the pump to take into account ambient conditions and also the viscosity of the fluid.

Setup

Press **Step** to move between options. Further options are signified by either < or > at the extreme right of the display. Press **Enter** to confirm settings.

ROM - provides user with software identification.

Beep - Audible signal on/off.

Lang - English, French or German

Signal - Step to the desired process signal for analogue control and press **Enter**. Options available are 4-20mA, 0-10mA, 0-20mA, 0-5V, 0-10V. These signal ranges correspond to 0-200rpm speed control. A confirmation screen will verify settings chosen. If the signal type required is not shown then use the "PROGRAM" option. The pump is controllable by an analogue process signal of up to 30V or 32mA. The pump will provide an increasing flow rate for a rising control signal (non-inverted response) or an increasing flow rate for a falling control signal (inverted response).

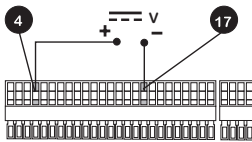

For voltage modes, a stable, variable DC voltage source can be used in conjunction with a DC voltmeter, (max 30V DC). (Refer to the 25 pin terminal strip wiring detail as an example of control circuitry). Circuit impedance 100k Ω . Polarity set for non-inverted response. Reverse polarity for inverted response.

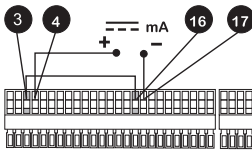

For current modes the same DC source can be used in conjunction with a DC milliampere meter, (maximum 32mA). (See 25 pin terminal strip detail). Circuit impedance 250 Ω . Polarity set for non-inverted response. Reverse polarity for inverted response.

Pump - When under RS232 control each individual pump must be identified. Select a number from 1-16.

Baud - Speed of signal transmission. Default setting 9600, range of setting include 1200, 2400, 4800, 9600.

Trim - This function will match the pumps signal conditioner to the analogue process control signal if they do not fully coincide. The user will be asked to apply zero, 20% and the maximum voltage or current that is required to be the control signal. Press enter after adjusting the process signal to each input level.



Never apply mains voltage across pins on the 25 pin terminal strip. Up to 5V TTL may be applied to pins 7 and 5, but do not apply voltage across any other pins. Failure to comply could cause permanent damage not covered by warranty. Do not use the mains power switch to control the pump for a high repetition of stop.starts. The auto-control facility should be used.

Autostart - If set to **On** when in **Manual** mode only, Autostart will allow the pump to restart pumping automatically after power-up following a mains supply interruption. If set to off the pump will restart and return to the Main Menu.

Remote Stop - Provides the option for keypad over-ride of remote stop.

Strobe - Monitor the pump dosing or motor state/direction of rotation using 2 high (5V) /low (0V) auxiliary signals outputted via the pumps 25 pin terminal strip. Auxiliary signals can be used, for example, to command a turntable or conveyor to move when a dose has been completed.

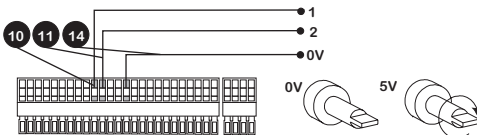

Line 1 can be set to change state every time the motor runs, or only when the motor runs to dispense a dose. The signal can be set high or low when the motor runs. **Line 2** changes state when the pump direction is changed. The screens allow the signal to be set high or low when the output shaft rotates clockwise.

Default - Press **Enter** at "Y55" to restore factory defaults.

Remote control



Never apply mains voltage across pins on the 25 pin terminal strip. Up to 5V TTL may be applied to pins 7 and 5, but do not apply voltage across any other pins. Failure to comply could cause permanent damage not covered by warranty. Do not use the mains power switch to control the pump for a high repetition of stop.starts. The auto-control facility should be used.

Pause dose

This function will pause a dose on for as long as a remote switch remains closed then allows the dose to continue when the switch is opened. Under Manual mode it will also act as a remote stop/start. Connect remote switch as in the Stop/Start diagram. Open to run pump, close to pause or stop pump.

Stop/Start

Connect remote switch between pins 7 and 16 of the 25D connector. A TTL compatible logic input (Low 0V, High 5V) may be applied to pin 7. Low input stops the pump, high input runs the pump. With no connection, the pump will default to running.



Direction

Connect remote switch between pins 5 and 16 and disable the front panel reversing control by linking pins 6 and 18 of the 25D connector. Open switch for clockwise rotation, close for counter-clockwise. Alternatively a TTL compatible logic input (Low 0, High 5V) may be applied to pin 5. Low input will run the pump in a counter-clockwise direction, High input in a clockwise rotation. No connection; the pump will default to clockwise rotation.

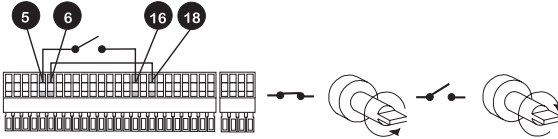

Speed

A remote potentiometer with a nominal value of between 1kΩ and 2kΩ with a minimum of 0.25W should be wired as shown. When using a remote potentiometer, do not apply a voltage/current control input signal at the same time. The speed control signal will require calibration relative to the minimum and maximum settings of the potentiometer. Use the offset and range potentiometers as described under calibration.

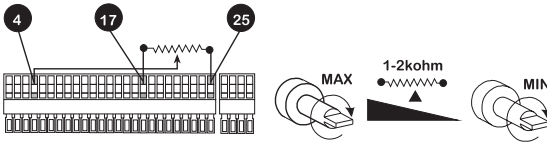

Tachometer

This facility can be used to indicate motor speed or total the number of motor revolutions. When using the square wave, the output is: 1179 cycles per output shaft revolution on the 220rpm drive. 733 cycles per output shaft revolution on the 55rpm drive.

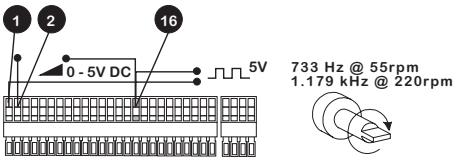

Care and maintenance

The only scheduled maintenance required on the 504Du/RL is to inspect the motor brushes and to replace them before their length is less than 6mm 1/4". The life of the brushes will depend on the duty of the pump, which is expected to be at least 10,000 hours at maximum speed. When the pump needs cleaning, remove the pumphead and use a mild solution of detergent in water. Do not use strong solvents.

If the gearbox is rebuilt you should use 15 ml of the recommended lubricant, which is RD105, this is a SAE 30 mineral oil loaded with molybdenum disulphide to form a soft fluid grease.

Specification

Maximum rotor speeds	55rpm, 220rpm
Voltage/frequency	100-120/220-240V 50/60Hz
Control range	220:1
Power consumption	100VA
Shaft torque	2.2Nm
Operating temperature range	5 to 40C
Storage temperature range	-40C to 70C
Weight 504Du/RL	9.4kg
Noise	<70dBA at 1m
Standards	IEC 335-1, EN60529 (IP55) Machinery Directive 89/392/EEC EN60204- 1 Low Voltage Directive 73/23/EEC EN61010- 1 EMC Directive:89/336/EEC EN50081-1 / EN50082-1

Specific drive performance details such as loaded drive speed variation against mains supply voltage fluctuation and drive stability from a cold start to normal operating temperature are available on request. For further information please contact Watson-Marlow Technical Support Department.

501RL pumphead

The 501RL pumphead has two spring-loaded working rollers, which automatically compensate for minor variations in tubing wall thickness, giving extended tube life. The 501RL is set during manufacture to accept tubing with wall thicknesses of between 1.6mm and 2.0mm, and internal diameters of up to 8.0mm. It is equipped with a “tool lockable” guard for increased safety. This should be locked shut whilst the pump is in use.

The pumphead can be run clockwise for extended tube life, or anti-clockwise to operate against higher pressures.

Flow rates

Flow rates for the 504Du/RL were obtained using silicone tubing with the pumphead rotating clockwise, pumping water at 20C with zero suction and delivery pressures. For critical applications determine flow rates under operating conditions.

501RL installation

Fit the track in any one of three orientations, over the drive shaft and locating boss. Secure the track with the locating screw. Ensure the drive shaft is degreased before locating the rotor onto the shaft via the split collet. Tighten the rotor screw to a torque of 3Nm to prevent the collet slipping during operation.

To reposition the track, swing out the crank handle to expose the rotor retaining screw. Turn the screw anticlockwise one turn to release the collet, and withdraw the rotor from the shaft. Loosen the track locating screw, and pull the track clear. Rotate the track to its new position and tighten the track locating screw. Use this method of removal and fitting in case cleaning is required.

Tube loading

Isolate pump from mains supply. Unlock and open the hinged guard and swing out the rotor crank handle until it locks into position. Select the length of tubing required, noting that approximately 240mm is required for the pumphead.

Fit one end of the tubing into one of the spring loaded clamps, and then, whilst rotating the rotor with the crank handle, feed the tubing between the rollers and the track, aligning it within the rotor tube guides. The tubing must lie naturally against the track and must not be twisted or stretched.



Fit the other end of the tubing into the second spring loaded clamp, ensuring that the tubing is not slack in the pumphead, since this can reduce tube life.

Close the crank handle and shut and lock the guard.

After the pump has been started, open the downstream clamp for a short time, so that the tube can find its natural length.

The 501RL pumphead is fitted with four-position tube clamps, to accommodate various tube diameters, which can be adjusted by pushing in or pulling out the bars at the top of the upper clamp and the bottom of the lower clamp. Set the clamps so that the minimum necessary pressure is applied to the tubing.



Roller adjustment

The 501RL has a factory set gap of 2.6mm between the rollers and the track and is suitable for tubing having wall thicknesses of between 1.6 and 2.0mm. Adjustment of the gap will be required if tubing having a wall thickness of less than 1.6mm is required. There is an adjusting screw on each of the two roller arms, and each of these screws will require adjustment. The correct gap is twice the wall thickness less twenty percent. Correct adjustment is important: over occlusion will reduce tube life; under occlusion will reduce pumping efficiency.

To change the gap setting, turn each adjusting screw clockwise to increase the gap, or anticlockwise to decrease the gap. A full turn changes the gap by 0.8mm.

To restore the original settings of 2.6mm, turn the adjusting screws until both rollers are just touching the track, then tighten each screw by three and a quarter turns. The 501RL2 has a factory set gap of 3.8mm between the wall and the track and is suitable for tubing having wall thickness of between 2.1 and 2.5mm.

Check moving parts of the rotor from time to time for freedom of movement. Lubricate pivot points and rollers occasionally with Teflon lubricating oil.

501RL Pumphead spares

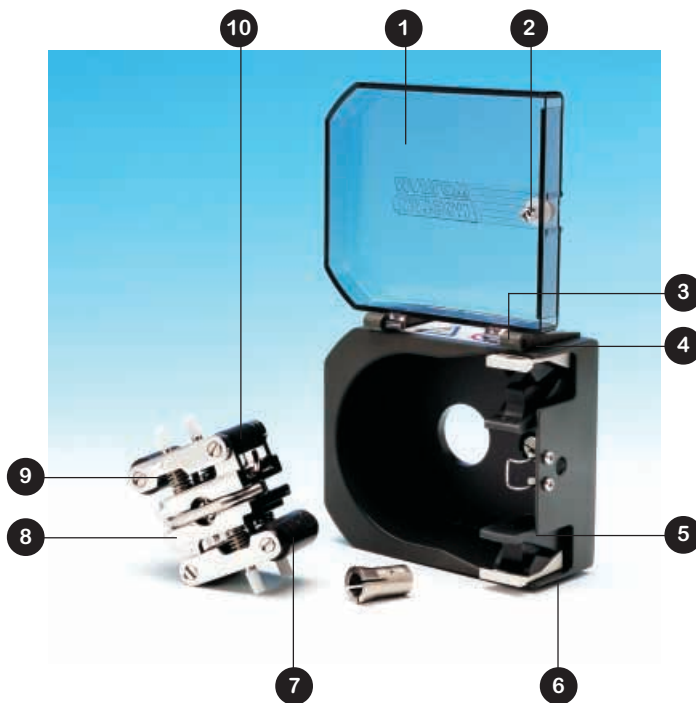

Number	Spare	Description
1	MN 0377M	Lockable guard
2	FN 4502	Lock
3	FN 2341	Hinge screw
4	MN 0266M	Hinge grey
5	MNA0114A	Tube clamp assembly
6	FN 2332	Screw
7	MN 0011T	Main roller
8	MNA0143A	501RL rotor assembly
9	SG 0001/SG 0002	Springs standard/hard
10	MN 0012T	Follower roller
	XX 0095	Teflon lubricant

Drive spares

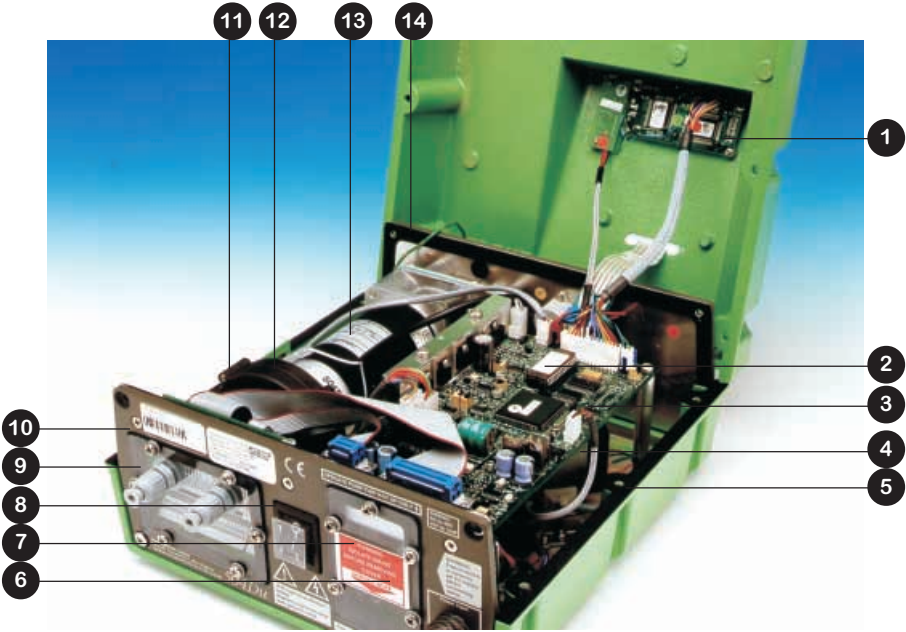





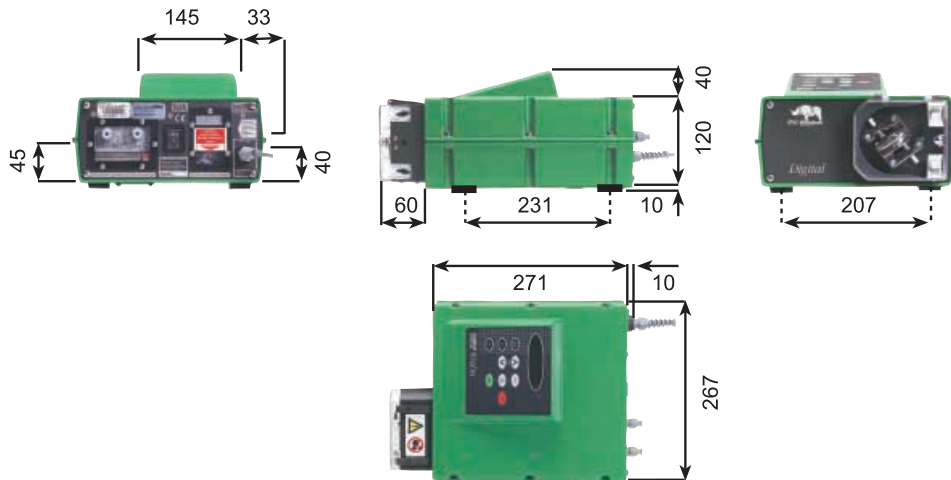







Number	Spare	Description
1	MN 1094B	Switch panel membrane
2	MNA0582A	ROM
3	MNA0655A	Speed control PCB (excluding ROM)
4	TR 0031	Transformer
5	MN 0487S	Top/bottom case gasket
6	FS 0003	Fuse 1.0 amp T type
7	MR 0669S	Recess cover
8	MR 0771S	Recess gasket
9	MN 1086S	Terminal strip recess window
10	MN 1087S	Window gasket
11	MN 0787M	Tacho disc
12	BM 0014 (x 2)	Motor brush
13	MNA0396A	Motor 55rpm
	MNA0388A	Motor 220rpm
14	MN 0488S	Front/rear panel gasket

Outline dimensions 504Du/RL



Technical data

						
English	User decision	Pump screen display	Terminal	Operation	Flow connector	Manual input
Italiano	Decisione dell'utente	Schermo della pompa	Terminale	Funzionamento	Raccordo flusso	Digitazione manuale
Svenska	Användarval	Display för pump	Terminal	Drift	Flödesanslutare	Manuell ingång
Deutsch	Benutzerentscheidung	Display der Pumpe	Terminal	Betrieb	Verbindungsstück	Manuelle Eingabe
Español	Selección del usuario	Pantalla bomba	Terminal	Operación	Conector de flujo	Introducción manual
Nederlands	Beslissing van de gebruiker	Pompdisplay	Aansluitblok	Operatie	Flowconnector	Invoer met de hand
Français	Décision utilisateur	Affichage de l'écran de la pompe	Terminal	Fonctionnement	Raccord de schema	Entrée manuelle
Português	Decisão do utilizador	Visor do ecrã da bomba	Terminal	Operação	Conector do caudal	Entrada manual
Suomi	Käyttäjän päätös	Pumpun ruutunäyttö	Pääte	Toiminta	Virtausliitin	Käsinsyöttö
Norsk	Brukeravgjørelse	Tegnute på pumpe	Terminal	Betjening	Strømnings-kobling	Manuelt inntak
Dansk	Bruger beslutning	Pumpens display (skærbilled) visning	Begyndelse (start)	Funktionsbeskrivelse	Funktionsforbindelse	Manuel funktion (tast ind)

							
English	Instruction reference	Keypad function	Keypad function	Keypad function	Keypad function	Keypad function	Keypad function
Italiano	Riferimento istruzioni	Funzione tastiera	Funzione tastiera	Funzione tastiera	Funzione tastiera	Funzione tastiera	Funzione tastiera
Svenska	Instruktionsreferens	Tangentbordsfunktion	Tangentbordsfunktion	Tangentbordsfunktion	Tangentbordsfunktion	Tangentbordsfunktion	Tangentbordsfunktion
Deutsch	Instruktionsverweis	Tastaturfunktion	Tastaturfunktion	Tastaturfunktion	Tastaturfunktion	Tastaturfunktion	Tastaturfunktion
Español	Referencia de instrucciones	Función teclado numérico	Función teclado numérico	Función teclado numérico	Función teclado numérico	Función teclado numérico	Función teclado numérico
Nederlands	Referentie naar instructie	Funcie op toetsenbord	Funcie op toetsenbord	Funcie op toetsenbord	Funcie op toetsenbord	Funcie op toetsenbord	Funcie op toetsenbord
Français	Référence instruction	Fonction clavier	Fonction clavier	Fonction clavier	Fonction clavier	Fonction clavier	Fonction clavier
Português	Referência de instrução	Função de teclado	Função de teclado	Função de teclado	Função de teclado	Função de teclado	Função de teclado
Suomi	Ohjeviite	Näppäimistötoiminto	Näppäimistötoiminto	Näppäimistötoiminto	Näppäimistötoiminto	Näppäimistötoiminto	Näppäimistötoiminto
Norsk	Instruksjonsreferanse	Tastaturfunksjon	Tastaturfunksjon	Tastaturfunksjon	Tastaturfunksjon	Tastaturfunksjon	Tastaturfunksjon
Dansk	Instruktionsreference	Tastaturfunktion	Tastaturfunktion	Tastaturfunktion	Tastaturfunktion	Tastaturfunktion	Tastaturfunktion

English

- A. Switch on power to drive
- B. User decision to calibrate
- C. Indication of head and tubing to which pump is currently calibrated
- D. Indication of default set up. Press enter if OK, press Step enter to change set up.
- E. Decision to change setup.
- F. Calibration option by pumphead and tubing or by calibration dose.
- G. Reference Calibration flow chart.
- H. After selecting calibration setting return to Main Menu.
- I. Set direction and speed. Start to run pump.

Italiano

- A. Accendere per azionare
- B. Decisione dell'utilizzatore di tarare
- C. Indicazione di testina e tubi rispetto ai quali la pompa è attualmente tarata
- D. Indicazione di impostazione dei valori predefiniti. Premere Enter se in ordine, premere Step per modificare l'impostazione.
- E. Decisione di modificare l'impostazione.
- F. Opzione di taratura per mezzo di testina pompante e tubi o per mezzo di dose di taratura. G - Diagramma schematico taratura di riferimento
- G. Dopo aver selezionato la regolazione della taratura, ritornare al Menu principale
- H. Regolare la direzione e la velocità. Avviare la pompa.

Svenska

- A. Slå på strömmen för drift.
- B. Val för att kalibrera.
- C. Indikering, på till vilket pumphuvud och vilken slang, pumpen för närvarande är kalibrerad
- D. Indikering på standardinställning. Tryck Enter om OK, tryck Step Enter för att ändra inställningen.
- E. Val att ändra inställning.
- F. Kalibreringstillval för pumphuvud och slang eller av kalibrering av dosering.
- G. Referens flödesschema för kalibrering.
- H. Efter att ha utfört kalibreringen, återvänd till huvudmenyn.
- I. Ställ in rotationsriktningen och hastigheten. Starta för att köra pumpen.

Deutsch

- A. Stromversorgung zum Antrieb einschalten
- B. Benutzer wählt Kalibrierung
- C. Anzeige des Kopfes und Schlauches, für den die Pumpe derzeit kalibriert ist
- D. Anzeige der Voreinstellung. Bei Akzeptierung Enter drücken, zur Änderung der Einrichtung Step Enter drücken.
- E. Einrichtung (Setup) wird geändert.
- F. Kalibrierungsoption nach Pumpenkopf und Schlauch oder Kalibrierungsdosierung
- G. Referenzkalibrierungs-Diagramm
- H. Nach der Wahl der Kalibrierungseinstellung zum Hauptmenü zurückkehren
- I. Richtung und Drehzahl einstellen. Start zum Pumpenbetrieb.

Español

- A. Poner en marcha
- B. Decisión del usuario de calibrar
- C. Indicación del cabezal y tubo según los cuales está calibrada la bomba actualmente.
- D. Indicación de configuración por defecto. Pulse OK si es correcta, pulse Step y Enter para cambiar la configuración.
- E. Decisión de modificar la configuración.
- F. Opción de calibración mediante el cabezal y, los tubos de la bomba o mediante la dosis de calibración.
- G. Diagrama de flujo de Calibración de Referencia.
- H. Después de seleccionar la configuración de calibración, regrese al Menú Principal.
- I. Fije la dirección y la velocidad. Ponga la bomba en marcha.

Nederlands

- A. Schakel aandrijving in.
- B. Beslissing gebruiker om te kalibreren.
- C. Indicatie van kop en slang waarvoor pomp momenteel is gekalibreerd.
- D. Indicatie van standaardinstellingen. Druk op Enter indien akkoord, druk op Step om instelling te veranderen.
- E. Beslissing om instelling te veranderen.
- F. Kalibratie-optie: via pompkop en slang of via kalibratiedosering.
- G. Referentie Kalibratie flowchart.
- H. Keer na kiezen van kalibratie-instelling terug naar Hoofdmenu.
- I. Stel draairichting en snelheid in. Start draaien van de pomp.

Français

- A. Mettre le moteur sous tension.
- B. Étalonnage décidé par l'utilisateur.
- C. Indication de la tête et de la tubulure pour lesquelles la pompe est actuellement calibrée.
- D. Indication de la configuration par défaut. Appuyer sur Enter pour confirmer, appuyer sur Step pour modifier la configuration.
- E. Décision de modifier la configuration.
- F. Option d'étalonnage par tête de pompe et tubulure ou par dose d'étalonnage.
- G. Tableau d'étalonnage de référence.
- H. Après la sélection du paramètre d'étalonnage, retourner au menu principal.
- I. Définir le sens et la vitesse. Démarrage de la pompe.

Português

- A. Ligar para pôr em marcha
- B. Decisão de calibrar, tomada pelo utilizador
- C. Indicação da cabeça e da tubagem para que a bomba está calibrada actualmente.
- D. Indicação de configuração por defeito. Prime Enter, caso esteja correcta; prima Step e Enter para alterar a configuração.
- E. Decisão de modificar a configuração.
- F. Opção de calibragem por meio da cabeça e tubagens da bomba ou mediante a dose de calibragem.
- G. Diagrama de fluxo de Calibragem de Referência.
- H. Depois de seleccionar a configuração de calibragem, regresse ao Menu Principal.
- I. Determine a direcção e a velocidade. Ponha a bomba em marcha.

Suomi

- A. Kytke virta käyttölaitteeseen
- B. Käyttäjän päätös kalibroida
- C. Pää ja letkut, joihin pumppu on nyt kalibroitu
- D. Oletusasetus. Paina enter, jos OK, paina Step enter, jos haluat muuttaa asetusta.
- E. Päätös muuttaa asetusta.
- F. Kalibroitinvaihtoehto pumppauspään ja letkujen mukaan tai kalibroitinnoksen mukaan.
- G. Referenssikalibroinnin vuokaavio.
- H. Kun olet valinnut kalibroitinasetuksen, palaa päävalikkoon.
- I. Aseta suunta ja nopeus. Paina Start, kun haluat käyttää pumppua.

Norsk

- A. Slå på strøm for drift
- B. Operatør avgjør kalibrering
- C. Indikasjon om hode og rør for pumpe som kalibreres for øyeblikket
- D. Indikasjon om oppsett av standardinnstilling. Trykk 'Enter' hvis OK, trykk på 'Step enter' for å forandre oppsett.
- E. Avgjørelse om å forandre oppsett.
- F. Kalibreringsoppsjon ved pumpehode og rør eller ved kalibreringsdose.
- G. Referanse for strømningsskjema til kalibrering.
- H. Etter valg av kalibreringsinnstilling gå tilbake til hovedmeny.
- I. Innstill retning og hastighet. Start for å sette i gang pumpen.

Dansk

- A. Tænd for motorens strømforsyning.
- B. Operatøren foretager den nødvendige kalibrering.
- C. Det aktuelle pumpehoved samt slangelysning vises, med mulighed for at recalibrere.
- D. Standard indstillingerne vises. Tryk på ENTER for at acceptere endstillingerne eller tryk på STEP/ENTER for at ændre indstillingerne.
- E. Foretag de nødvendige ændringer.
- F. Mulighed for at kalibrere, ved enten at vælge andet pumpehoved og/eller slangelysning eller ved hjælp af kalibreringsdosis..
- G. Se diagram for kalibrering.
- H. Gå tilbage til MAIN Menu, når de ønsker kalibreringsindstillinger er foretaget, eller operatøren ønsker at forlade kalibrering, uden at foretage yderligere.
- I. Indstil omdrejningsretning og -hastighed. Start pumpen.

English

- J. Prompt to set direction of rotation, speed
- K. Set direction and speed at keypad
- L. Press Start to start calibration dose
- M. Wait Press Stop when ready
- N. After 15 seconds prompt will change to Press stop
- O. Indication of current calibration settings.
- P. Enter actual volume/weight physically measured to allow for viscosity of fluid. Use Speed increment or decrement keys to increase or decrease the displayed volume/weight
- Q. Go to the flow chart outlining Start-up.

Italiano

- J. Messaggio per regolare la direzione di direzione, velocità
- K. Impostare la direzione e la velocità sul tastierino numerico
- L. Premere Start (avviamento) per avviare la dose di taratura
- M. Attendere Press Stop (premere arresto) quando pronti
- N. Dopo 15 secondi il messaggio diventa Press stop (premere arresto)
- O. Indicazione delle regolazioni della taratura attuali
- P. Immettere il volume/peso reali fisicamente misurati per tenere conto della viscosità del liquido. Usare i tasti di aumento o diminuzione della velocità per aumentare o diminuire il volume/peso visualizzati.
- Q. Passare al diagramma schematico che descrive l'avviamento.

Svenska

- J. Bekräfta val av rotationsriktning och hastighet.
- K. Ställ in rotationsriktning och hastighet vid tangentbordet
- L. Tryck Start för att starta kalibreringsdos.
- M. Vänta, tryck Stopp när den är klar.
- N. Efter 15 sekunder kommer prompten r att ändras till Tryck stopp.
- O. Indikering av nuvarande kalibreringsinställningar.
- P. Skriv in verklig volym/vikt, fysiskt mätt för att ta hänsyn till viskositeten. Använd hastighet öknings eller minsknings tangenterna för att öka eller minska den visade volymen/vikten.
- Q. Gå till flödesschemat som visar uppstarten.

Deutsch

- J. Aufforderung zur Einstellung der Drehrichtung, Drehzahl
- K. Richtung und Drehzahl an der Tastatur eingeben
- L. Zum Starten der Kalibrierungsdosierung START drücken
- M. Warten bei Bereitschaft Stop drücken
- N. Nach 15 Sekunden ändert sich die Aufforderung zu Stop drücken
- O. Anzeige der gegenwärtigen Kalibrierungseinstellungen
- P. Tatsächliches physikalisches gemessenes Volumen/Gewicht eingeben, um die Viskosität der Flüssigkeit mit einzuberechnen. Die Drehzahlsteigerungs- oder Reduzierungstasten zur Steigerung oder Reduzierung des angegebenen Volumens/Gewichtes verwenden.
- Q. Zum Diagramm übergehen, das Starten umschreibt.

Español

- J. Indicación para fijar la dirección y velocidad de rotación.
- K. Fije la dirección y la velocidad con el teclado numérico.
- L. Pulse Start (Inicio) para iniciar la dosis de calibración.
- M. Espere la señal de Press Stop (pulsar parada) cuando esté listo.
- N. Después de 15 segundos, la indicación cambiará a Press stop
- O. Indicación de las configuraciones de calibración actuales.
- P. Introduzca el volumen y peso real medidos físicamente para que se tenga en cuenta la viscosidad del fluido. Use las teclas de aumento y reducción de Speed (velocidad) para aumentar o disminuir el volumen/peso que aparecen en pantalla.
- Q. Desplácese al diagrama de flujo marcando Start-up (Arranque).

Nederlands

- J. Vraagt naar instelling van draairichting en snelheid.
- K. Stel draairichting en snelheid in met toetsenbord.
- L. Druk op Start om kalibratiedosering te starten.
- M. Wacht en druk op Stop indien gereed.
- N. Na 15 s zal display vragen om Stop in te drukken.
- O. Indicatie van huidige kalibratie-instellingen.
- P. Voer feitelijk volume of gewicht in dat fysiek is gemeten, als correctie voor viscositeit van de vloeistof. Gebruik de toetsen voor verhoging of verlaging van toerental om het weergegeven volume of gewicht te verhogen of te verlagen.
- Q. Ga naar Start-up van de flowchart.

Français

- J. Message pour la définition du sens et de la vitesse de rotation.
- K. Définir le sens et la vitesse au clavier.
- L. Appuyer sur Start pour lancer la dose d'étalonnage.
- M. Attendre Press Stop quand la pompe est prête.
- N. Au bout de 15 secondes le message est remplacé par Press Stop.
- O. Indication des paramètres d'étalonnages actuels.
- P. Saisir les valeurs réelles mesurées des poids/volume pour la viscosité du liquide. Utiliser les touches d'incrémentatation et de décrémentatation Speed pour augmenter ou diminuer les poids/volume affichés.
- Q. Aller au tableau présentant le démarrage.

Português

- J. Solicitação para determinar a direcção e velocidade de rotação.
- K. Determine a direcção e velocidade com o teclado numérico.
- L. Prima Start (Inicio) para iniciar a dose de calibragem.
- M. Espere pelo sinal de Press Stop (premir paragem) quando estiver concluída.
- N. Ao fim de 15 segundos, a indicação mudará para Press stop
- O. Indicação das configurações de calibragem actuais.
- P. Introduza o volume e peso real medidos fisicamente para que seja tomada em conta a viscosidade do fluido. Use as teclas de aumento e redução de Speed (velocidade) para aumentar ou diminuir o volume/peso que aparecem no ecrã.
- Q. Passe para o diagrama de fluxo marcando Start-up (Arranque).

Suomi

- J. Kehote asettaa pyörimissuunta, nopeus.
- K. Aseta suunta ja nopeus näppäimistöllä.
- L. Paina Start, kun haluat käynnistää kalibrointiannoksen.
- M. M - Odota ja paina Start, kun olet valmis.
- N. 15 sekunnin kuluttua kehote muuttuu arvoksi Paina stop.
- O. Nykyiset kalibrointiannokset.
- P. Syötä varsinainen määrä/paino, jotka on fyysisesti mitattu nesteen viskositeetin sallimiseksi. Käytä nopeuden lisäämis- tai vähennysnäppäimiä, kun haluat lisätä tai vähentää näytettyä määrää/painoa.
- Q. Siirry vuokaavioon, jossa on esitetty käynnistys.

Norsk

- J. Påminnelse om å innstille retning og rotasjon, og hastighet
- K. Innstill retning og hastighet på tastbordet
- L. Strykk på 'Start' for å starte kalibreringsdosering
- M. Vent, trykk på 'Stopp' (Press Stop) når klar
- N. Etter 15 sekunder vil påminnelse forandres til trykk på stopp (Press stop)
- O. Indikasjon på eksisterende kalibreringsinnstillinger.
- P. Sett inn aktuelt volum/vekt som er fysisk målt for å ta hensyn til væskens viskositet. Bruk tastene for hastighetsøkning eller minskning for å øke eller minske vist volum/vekt
- Q. Gå til strømningsskjema som oppgir oppstart (Start-up).

Dansk

- J. Indstil omdrejnings retning og hastighed.
- K. Indstil omdrejningsretning og –hastighed ved hjælp af tastaturet.
- L. Tryk på Start for at starte kalibreringsjusteringen.
- M. Vent, og tryk på Stop, når du er klar.
- N. Efter 15 sekunder ændres displayvisningen. Tryk på Stop.
- O. De aktuelle kalibreringsindstillinger vises.
- P. Indtast den faktiske, målte fysiske volumen/vægt for væskeviskositet. Brug ∇ eller \blacktriangle ("Pil op" eller "Pil Ned") til at justere den viste volumen/vægt.
- Q. Gå til diagrammet for opstartsprocedure.

English

- R. Move between the pumphead or tubing options using the Step key. Press Enter to select pumphead type or tubing size. An option will be given at this stage to use a calibration dose. This will over-ride the head and tubing calibration. Press No to return to Main Menu or Yes to override and use a calibration dose.

Italiano

- R. Spostarsi tra le opzioni della testina pompante o dei tubi usando il tasto Step. Immettere il tipo di testina pompante o la misura dei tubi prescelti. A questo punto viene offerta l'opzione di usare una dose di taratura. Se la si sceglie, si salta la taratura della testina e dei tubi. Premere No per tornare al Menu principale o Si per saltarla e usare una dose di taratura.

Svenska

- R. Flyttning mellan pumphuvud eller slang tillval, genom att använda Step tangenten. Tryck Enter för att välja pumphuvuds typ eller slangstorlek. Ett tillval kommer att anges vid detta steg för att använda en kalibrerad dosering. Detta kommer att förregla pumphuvudets och slangens kalibreringen. Tryck Nej för att återvända till huvudmenyn eller Ja för att förregla och använda en kalibrerad dosering.

Deutsch

- R. Zwischen Pumpenkopf- und Schlauchoptionen mit Hilfe der Step-Taste überwechseln. Zur Wahl eines Pumpenkopftyps oder einer Rohrgröße Enter drücken. Es erscheint dann eine Option zur Verwendung einer Kalibrierungsdosis. Hierdurch wird die Kopf- und Rohrkalibrierung überschaltet. No (Nein) drücken, um zum Hauptmenü zurückzukehren, oder Yes (Ja) drücken, um eine Kalibrierungsdosierung zu verwenden.

Español

- R. Desplácese entre las opciones de cabezal o tubo de la bomba utilizando la tecla Step. Pulse Enter para seleccionar el tipo de cabeza de bomba o el tamaño de los tubos. En esta fase, aparecerá una opción para utilizar la dosis de calibración que anulará la calibración del cabezal y los tubos. Pulse No para volver al Main Menu (Menú principal) o Yes (Sí) para anular y utilizar una dosis de calibración.

Nederlands

- R. Loop tussen de opties voor de pompkop en de slang met behulp van de Step-toets. Druk op Enter om het type pompkop en de grootte van de slang te kiezen. In deze fase zal een optie worden gegeven om een kalibratiedosering te gebruiken. Deze zal de kalibratie van de kop en de slang overschrijven. Druk op No om terug te keren naar het hoofdmenu of op Yes om te overschrijven en een kalibratiedosering te gebruiken.

Français

- R. Passer de l'option tête de pompe à l'option tubulure au moyen de la touche Step. Appuyer sur Enter pour sélectionner le type de tête de pompe ou la taille de la tubulure. Une option est proposée à ce stade pour utiliser la dose d'étalonnage. Cette action a priorité sur l'étalonnage de la tubulure. Appuyer sur No pour retourner au menu principal, ou sur Yes pour utiliser en priorité la dose d'étalonnage.

Português

- R. Desloque-se entre as opções de cabeça ou tubagem da bomba utilizando a tecla Step. Prima Enter para seleccionar o tipo de cabeça ou o a dimensão dos tubos. Nesta fase, aparecerá uma opção para utilizar a dose de calibragem que anulará a calibragem da cabeça e da tubagem. Prima No (Não) para regressar ao Main Menu (Menu principal) ou Yes (Sim) para anular e utilizar uma dose de calibragem.

Suomi

- R. Siirry pumpauspään ja letkujen vaihtoehtojen välillä käyttämällä Step-näppäintä. Paina Enter, kun haluat valita pumpauspään tyyppiä tai letkujen koon. Tässä vaiheessa käyttäjälle annetaan mahdollisuus käyttää kalibrointiannosta. Tämä ohittaa pään ja letkujen kalibroinnin. Paina No, jos haluat palata päävalikkoon tai Yes, jos haluat ohittaa ja käyttää kalibrointiannosta.

Norsk

- R. Flytt mellom pumpehodet eller røropsjoner ved å bruke Step-tasten. Trykk på 'Enter' for å velge type pumpehode eller rørstørrelse. En opsjon blir gitt på dette tidspunktet om å bruke kalibreringsdosering. Dette vil oppheve hodet og rørkalibreringen. Trykk på 'No' (nei) for å gå tilbake til hovedmenyen (Main Menu) eller Ja (Yes) for overstyring og bruk av en kalibreringsdosering.

Dansk

- R. Brug Step for at springe imellem mulighederne, brug Enter for at foretage valg. For at komme tilbage til Kalibrations side; der trykkes Enter når man har Step pet til No for at gå til Main Menu.

Error Messages

The pump will retain data such as pumphead, tube size, calibration, rpm and direction of rotation. If the data has been corrupted, the following two screens will appear for 2 seconds each in a continuous cycle until **Stop** or **Enter** are pressed.

If the pump detects any other fault condition, the following two screens will appear in a continuous cycle until **Stop** or **Enter** are pressed.

This screen indicates that the motor has stalled or that a loss of tachometer pulses has been selected. Clear the cause of stalling and power the pump off and on. If the error persists seek qualified assistance.

Messaggi di errore

La pompa conserva determinati dati tipo la misura dei tubi, la taratura, i giri/minuto e la direzione di rotazione. Se i dati si sono corrotti, appariranno continuamente, per 2 secondi ciascuna, le due schermate riprodotte di seguito fino a quando viene premuto **Stop** o **Enter**.

Se la pompa rileva qualsiasi altra condizione di guasto, appariranno continuamente, per 2 secondi, le due schermate riprodotte di seguito fino a quando viene premuto **Stop** o **Enter**.

Questa schermata indica che il motore si è spento oppure che è stata selezionata la perdita di impulsi del contagiri. Eliminare la causa dello spegnimento e accendere e spegnere la pompa. Se l'errore persiste, rivolgersi ad un centro di assistenza qualificato.

Fel meddelanden

Pumpen kommer att bibehålla data, så som pump huvud, slangstorlek, kalibrering, varvtal och rotationsriktning. Om datan har blivit fel, kommer följande två skärmbilder att visas i 2 sekunder båda i en kontinuerlig följd tills **Stop** eller **Enter** trycks ner.

Om pumpen upptäcker några andra fel, kommer följande två skärmar att dyka upp i en kontinuerlig följd tills **Stop** eller **Enter** trycks ner.

Denna skärm indikerar att motorn har stannat eller en minskning av pulserna. Åtgärda orsaken och slå av och på pumpen. Om felet fortsätter kontakta servicepersonal.

Fehlermeldungen

Die Pumpe speichert Daten wie beispielsweise Pumpenkopf, Schlauchgröße, Kalibrierung, Upm und Drehrichtung. Falls die Daten verfälscht wurden, erscheinen die folgenden beiden Bildschirmseiten jeweils 2 Sekunden lang in einem ständigen Zyklus, bis Stop oder Enter gedrückt wird.

Falls die Pumpe jegliche anderen Fehlfunktionszustände erfährt, erscheinen die folgenden zwei Bildschirmseiten in einem ständigen Zyklus, bis Stop oder Enter gedrückt wird.

Diese Bildschirmseite zeigt an, daß der Motor festgefahren ist oder daß ein Verlust der Tachoimpulse gewählt wurde. Den Grund beheben, der zum Abwürgen des Motors führte und die Pumpe ein- und ausschalten. Falls die Fehlfunktion weiterhin auftritt, qualifizierte Hilfe ersuchen.

Mensajes de error

La bomba memorizará datos tales como el cabezal de la bomba, el tamaño de los tubos, la calibración, rpm y dirección de rotación. Si los datos están dañados, aparecerán las dos pantallas siguientes durante 2 segundos cada una en un ciclo continuo hasta que pulse **Stop** o **Enter**.

Si la bomba detecta algún otro error, las dos pantallas siguientes aparecerán en un ciclo continuo hasta que pulse **Stop** o **Enter**.

Esta pantalla indica que el motor se ha parado o se ha seleccionado una pérdida de pulsaciones de tacómetro. Averigüe la causa de la parada y apague y encienda la bomba. Si persistiera el error, consulte a una persona cualificada.

Foutmeldingen

De pomp zal gegevens vasthouden zoals pompkop, slanggrootte, kalibratie, toerental en draairichting. Als de gegevens zijn verstoord zullen in een continue cyclus de volgende twee schermen elk steeds 2 s verschijnen, totdat op Stop of Enter wordt gedrukt.

Als in de pomp enige andere foutconditie optreedt, zullen de volgende twee schermen in een continue cyclus verschijnen, totdat op Stop of Enter wordt gedrukt.

Dit scherm geeft aan dat de motor tot stilstand is gekomen of dat een verlies van tachometerpulsen is opgetreden. Neem de oorzaak van de stilstand weg en schakel de pomp uit en aan. Als de fout blijft bestaan, schakel dan hulp van een deskundige in.

Messages d'erreur

La pompe conserve les données telles que la tête de pompe, la taille du tube, étalonnage, tr/min, et sens de la rotation. Si les données ont été détériorées, les deux écrans apparaissent pendant 2 secondes selon un cycle continu jusqu'à ce qu'on appuie sur Stop ou sur Enter.

Si la pompe détecte d'autre condition d'erreur, les deux écrans apparaissent pendant 2 secondes selon un cycle continu jusqu'à ce qu'on appuie sur Stop ou sur Enter.

Cet écran indique que le moteur a calé ou qu'une perte d'impulsions du tachymètre a été détectée. Remédier à la cause de l'arrêt, puis éteindre et rallumer la pompe. Si l'erreur persiste, demander une assistance qualifiée.

Mensagens de erro

A bomba memorizará dados como a cabeça da bomba, as dimensões dos tubos, a calibragem, rpm e sentido de rotação. Se os dados apresentarem danos, aparecerão os dois ecrãs seguintes, cada um num ciclo contínuo, até premir **Stop** ou **Enter**.

Se a bomba detectar mais algum erro, os dois ecrãs seguintes aparecerão num ciclo contínuo até premir **Stop** ou **Enter**.

Este ecrã indica que o motor parou ou que foi seleccionada uma perda de impulsos do taquímetro. Averigüe a causa desta paragem e desligue e ligue a bomba. Caso o erro persista, procure assistência qualificada.

Mensagens de erro

A bomba memorizará dados como a cabeça da bomba, as dimensões dos tubos, a calibragem, rpm e sentido de rotação. Se os dados apresentarem danos, aparecerão os dois ecrãs seguintes, cada um num ciclo contínuo, até premir **Stop** ou **Enter**.

Se a bomba detectar mais algum erro, os dois ecrãs seguintes aparecerão num ciclo contínuo até premir **Stop** ou **Enter**.

Este ecrã indica que o motor parou ou que foi seleccionada uma perda de impulsos do taquímetro. Averigüe a causa desta paragem e desligue e ligue a bomba. Caso o erro persista, procure assistência qualificada.

Virheilmoitukset

Pumpussa tallennetaan sellaiset tiedot kuten pumppauspää, kalibrointi, rpm ja pyörimissuunta. Jos tiedot ovat korruptoituneet, seuraavat kaksi näyttöä ilmestyvät näkyviin 2 sekunnin ajaksi kumpikin jatkuvasti, kunnes painetaan Stop tai Enter.

Jos pumpussa havaitaan joku muu virhetila, seuraavat kaksi näyttöä ilmestyvät näkyviin jatkuvasti, kunnes painetaan Stop tai Enter.

Tämä näyttö ilmaisee, että moottori on pysähtynyt tai että on valittu kierrospulssien loppuminen. Selvitä pysähdyksen syy, ja kytke pumpun virta pois päältä ja päälle. Jos virhe ei poistu, ota yhteys huoltoliikkeeseen.

Feilmeldinger

Pumpen vil beholde data slik som pumpehode, rørstørrelse, kalibrering, omdr.min. og rotasjonsretning. Hvis datakorupsjon forekommer, vil de følgende to skjermbildene vises i 2 sekunder, hver i en kontinuerlig syklus inntil Stop eller Enter trykkes.

Hvis pumpen oppdager noen andre feiltilstander, vil de følgende to skjermbildene vises inntil Stop eller Enter trykkes.

Dette skjermbildet indikerer at motoren har stoppet, eller at tap av takometerpulser er oppdaget. Slett årsaken til stopp og sett pumpen AV og PÅ. Hvis feilen fortsetter, få tak i kyndig hjelp.

Fejlmeddelelser

Pumpen indsamler data såsom pumpehoved, slangelysning kalibrering, omdr./min. og rotationsretning. Hvis dataene er beskadiget, vises følgende to display i 2 sekunder skiftevist, indtil der trykkes på **Stop** eller **Enter**.





Hvis pumpen finder en anden fejl i systemet, vises følgende to display skiftevist, indtil der trykkes på **Stop** eller **Enter**.

Displayet viser, at der er sket et motorstop, eller at der er mangler en tacho pals. Fejlen skal udbedres, hvorefter strømmen skal afbrydes og tændes igen. Hvis fejlen genopstår, skal man søge kvalificeret hjælp.







	#			
English	Tube number	Tube bore	Stop	rpm
Italiano	Numero tubo	Diametro tubo	Arresto	giri/ minuto
Svenska	Slangnummer	Slanginner-diameter	Stopp	vpm
Deutsch	Schlauch-Nr	Schlauch ID	Stop	Upm
Español	Número de tubo	Diámetro interior del tubo	Parada	rpm
Nederlands	Slangnummer	Slangdoorlaat	Stoppen	omw/min
Français	Numéro de tuyau flexible	Diamètre Intérieur de tuyau flexible	Arrêt	tr/mn
Português	Número do tubo	Diâmetro interno do tubo	Paragem	rpm
Suomi	Slangennummer	Slangediameter	Pysäytys	rpm
Norsk	Letkun numero	Letkun sisähalkaisija	Stopp	omd/min
Dansk	Slange nummer	Slange lysning	Stop	omdr/min

English	Pressure (+)	Suction	Clockwise (rpm)	Anticlockwise (rpm)
Italiano	Pressione (+)	Aspirazione	Senso di rotazione orario (giri/ minuto)	Senso di rotazione antiorario (giri/ minuto)
Svenska	Tryck (+)	Sugförmåga	Medurs (rpm)	Moturs (rpm)
Deutsch	Druck (+)	Saugseitiger Unterdruck	Drehung im den Uhrzeigersinn (Upm)	Drehung gegen den Uhrzeigersinn (Upm)
Español	Presión (+)	Aspiración	Rotación sentido reloj (rpm)	Rotación contrasentido reloj (rpm)
Nederlands	Druk (+)	Onderdruk zuigzijde	Draairichting rechtsom (omw/min)	Draairichting linksom (omw/min)
Français	Refolement (+)	Aspiration	Sens horaire (tr/mn)	Sens anti-horaire (tr/mn)
Português	Pressão (+)	Sucção	Rotação no sentido dos ponteiros do relógio (rpm)	Rotação inversa à dos ponteiros do relógio (rpm)
Suomi	Paine (+)	Imykyky	Pyörintäsuunta myötäpäivään (rpm)	Pyörintäsuunta vastapäivään (rpm)
Norsk	Tryck (+)	Sugehøyde	Med klokken (omd/min)	Mot klokken (omd/min)
Dansk	Tryk (+)	Sugehøjde	Omdrejningsretning med uret (omdr/min)	Omdrejningsretning imod uret (omdr/min)

501RL, 501RL2 (ml/min)











Flow rates. Portate. Flödesområde. Fördermengen. Caudales. Flowbereiken. Débits. Caudais. Virtausmäärät. Leveringsmengder. Flow mængder								
	#	112	13	14	16	25	17	18
	mm	0.5	0.8	1.6	3.2	4.8	6.4	8.0
	"	1/50	1/32	1/16	1/8	3/16	1/4	5/16
	55	2.3	6.7	24	100	220	350	550
	220	9.2	27	94	410	890	1400	2200

313/314 (ml/min)

















Flow rates. Portate. Flödesområde. Fördermengen. Caudales. Flowbereiken. Débits. Caudais. Virtausmäärät. Leveringsmengder. Flow mængder								
	#	112	13	14	16	25	17	18
	mm	0.5	0.8	1.6	3.2	4.8	6.4	8.0
	"	1/50	1/32	1/16	1/8	3/16	1/4	5/16
313								
	55	1.5	3.9	15	55	121	198	275
	220	6.6	15	60	220	484	792	1100
314								
	55	1.5	3.3	13	46	104	165	220
	220	6.6	13	55	186	418	660	880

313





Maximum number of pumpheads. Numero massimo di testine. Max antal pumphus. Max. Anzahl der Pumpenköpfe. Máximo número de cabezales. Maximum aantal pompkoppen. Nombre maximum de têtes de pompe. Numero máximo de cabeças de bombas. Pumpauspáiden maks lukumäärä. Maksimum annall pumpehoder. Maximum antal pumpehoveder

313/314 Peroxide/ Platinum Silicone								
(0 ≤ bar ≤ 0.5)								
(0.5 ≤ bar ≤ 2.0)								
	#	112	13	14	16	25	17	18
	mm	0.5	0.8	1.6	3.2	4.8	6.4	8.0
	"	1/50	1/32	1/16	1/8	3/16	1/4	5/16
	55	6	6	6	6	6	4	3
	220	6	6	6	6	6	4	3
313/314 Marprene, Tygon, Neoprene, Viton								
(0 ≤ bar ≤ 0.5)								
(0.5 ≤ bar ≤ 2.0)								
	#	112	13	14	16	25	17	18
	mm	0.5	0.8	1.6	3.2	4.8	6.4	8.0
	"	1/50	1/32	1/16	1/8	3/16	1/4	5/16
	55	6	6	6	6	5	3	3
	220	6	6	6	6	5	3	3

505CA (ml/min)

Flow rates. Portate. Flödesområde. Fördermengen. Caudales. Flow bereiken. Débits. Caudais. Virtausmäärät. Leveringsmengder. Flow mængder								
 mm	0.13	0.19	0.25	0.38	0.50	0.63	0.76	
 "	0.005	0.007	0.01	0.015	0.02	0.025	0.03	
 55	0.0006	0.0009	0.0013	0.0036	0.0056	0.0083	0.011	48
 170	0.19	0.29	0.44	1.22	1.90	2.82	3.81	
 mm	0.88	1.02	1.14	1.29	1.42	1.52	1.65	
 "	0.035	0.04	0.045	0.05	0.055	0.06		
 55	0.016	0.021	0.026	0.033	0.04	0.043	0.051	48
 170	5.51	7.11	8.84	11.2	13.6	14.5	17.4	
 mm	1.85	2.05	2.38	2.54	2.79			
 "	0.07	0.08	0.09	0.1	0.11			
 55	0.063	0.076	0.092	0.107	0.12			48
 170	21.4	26.0	31.2	36.5	42.0			
  : < 170								

501RL2

 (2.4mm) Product codes. Codici prodotto. Produktkod. Produkt Code. Códigos de producto. Bestelnummers. Références produits. Códigos de Produto. Tuotetunnukset. Produktkoder. Produktkoder					
 mm	 "	 #	Peroxide Silicone	Platinum Silicone	Marprene
1.6	1/16	119	910.0016.024	913.0016.024	902.0016.024
3.2	1/8	120	910.0032.024	913.0032.024	902.0032.024
4.8	3/16	15	910.0048.024	913.0048.024	902.0048.024
6.4	1/4	24	910.0064.024	913.0064.024	902.0064.024
8.0	5/16	121	910.0080.024	913.0080.024	902.0080.024
9.6	3/8	122	910.0096.024	913.0096.024	902.0096.024

501RL, 313

Product codes. Codici prodotto. Produktkod. Produkt Code. Códigos de producto. Bestelnummers. Références produits. Códigos de Produto. Tuotetunnukset. Produktkoder. Produktkoder

						
mm	"	#	Marpene	Bioprene	Peroxide Silicone	Platinum Silicone
0.5	1/50	112	902.0005.016	903.0005.016	910.0005.016	913.0005.016
0.8	1/32	13	902.0008.016	903.0008.016	910.0008.016	913.0008.016
1.6	1/16	14	902.0016.016	903.0016.016	910.0016.016	913.0016.016
3.2	1/8	16	902.0032.016	903.0032.016	910.0032.016	913.0032.016
4.8	3/16	25	902.0048.016	903.0048.016	910.0048.016	913.0048.016
6.4	1/4	17	902.0064.016	903.0064.016	910.0064.016	913.0064.016
8.0	5/16	18	902.0080.016	903.0080.016	910.0080.016	913.0080.016

						
mm	"	#	Butyl *	Tygon	Fluorel	Neoprene
0.8	1/32	13				920.0008.016
1.6	1/16	14	930.0016.016	950.0016.016	970.0016.016	920.0016.016
3.2	1/8	16	930.0032.016	950.0032.016	970.0032.016	920.0032.016
4.8	3/16	25	930.0048.016	950.0048.016	970.0048.016	920.0048.016
6.4	1/4	17	930.0064.016	950.0064.016	970.0064.016	920.0064.016
8.0	5/16	18	930.0080.016	950.0080.016	970.0080.016	920.0080.016

* Not suitable for use with 313 pumpheads. Non idoneo per essere usato con la testina 313. Ej lämplig för användning med 313 pumphus. Nicht geeignet für pumpenkopf 313. No es adecuado para su uso en cabezas 313. Niet geschikt in combinatie met de 313 pompkop. Pas utilisable avec tête de pompe 313. Inadequado para uso com cabeças de bomba 313. Ei sovi käytettäväksi 313 pumppupään kanssa. Egner ikke å bruke med 313 pumpehode. Ikke egnet til brug i 313 pumpehoveder.

501RL

Flow rates. Portate. Flödesområde. Fördermengen. Caudales. Flow bereiken. Débits. Caudais. Virtausmäärät. Leveringsmængder. Flow mængder

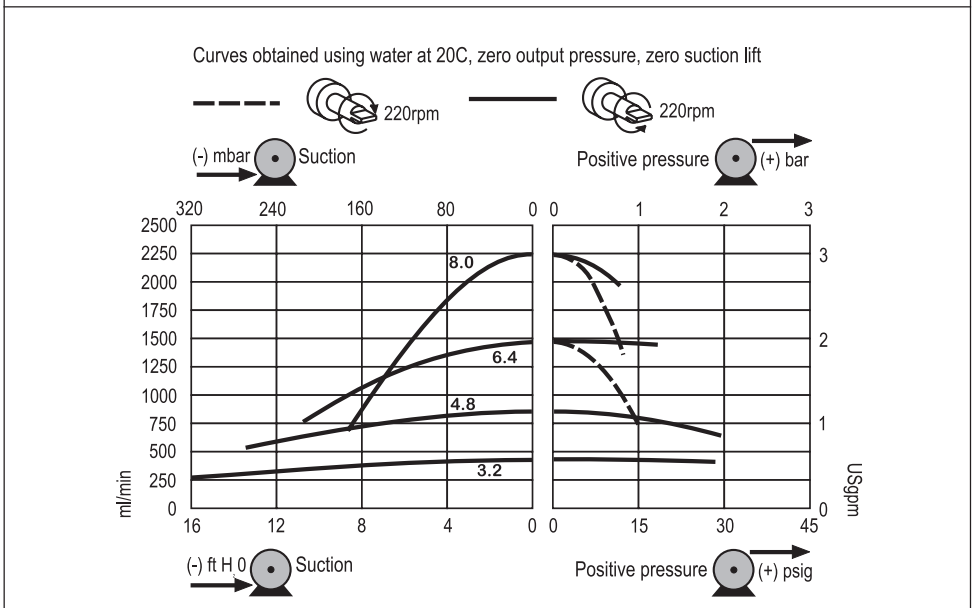

Watson-Marlow, Bioprene and Marprene are trademarks of **Watson-Marlow Limited**.

Tygon is a trademark of the **Norton Company**.

Warning, These products are not designed for use in, and should not be used for patient connected applications.

The information contained in this document is believed to be correct but **Watson-Marlow Limited** accepts no liability for any errors it contains, and reserves the right to alter specifications without notice.

Watson Marlow, Bioprene e Marprene sono marchi registrati della **Watson-Marlow Limited**.

Tygon è un marchio registrato della **Norton Company**

Attenzione, Questi prodotti non sono stati costruiti non devono essere usati per applicazioni in cui si debbano collegare a pazienti umani.

Riteniamo che tutte le informazioni fornite nel presente catalogo siano corrette tuttavia la **Watson-Marlow** non accetta alcuna responsabilità per eventuali errori, e si riserva il diritto di modificare senza alcun preavviso le caratteristiche indicate.

Watson-Marlow, Bioprene och Marprene utgör av **Watson-Marlow Limited** inregistrerade varumärken.

Tygon utgör ett av **Norton** företaget inregistrerat varumärke

Varning, Dessa produkter är inte avsedda för användning i samband med apparatur som ansluts till patienter.

Den information som ingår i detta dokument anses vara riktig, men **Watson-Marlow Ltd** påtar sig inte någon ansvarsskyldighet för eventuella felaktigheter däri, och förbehåller sig rätten att ändra specifikationerna utan meddelande på förhand.

Watson-Marlow, Bioprene und Marprene sind eingetragene Markennamen von **Watson-Marlow Limited**.

Tygon ist eingetragener Markenname der **Norton Company**

Achtung! Diese Produkte sind nicht konzipiert für den Gebrauch am Patienten und dürfen auch nicht für Anwendungen verwendet werden, die mit Patienten direkt verbunden sind.

Die in diesem Katalog enthaltenen Informationen sind korrekt. **Watson-Marlow Limited** übernimmt jedoch keinerlei Haftung für irgendwelche Fehler, die darin enthalten sind und behält sich das Recht vor, Spezifikationen zu ändern ohne darauf hinzuweisen.

Watson-Marlow, Bioprene y Marprene son marcas registradas de **Watson-Marlow Limited**.

Tygon es una marca registrada de **Norton Company**

Advertencia, Estos productos no están diseñados para uso en aplicaciones conectadas a pacientes y no deben ser utilizados para estos usos.

La información contenida en este documento está creada para ser correcta pero **Watson-Marlow Limited** no acepta ninguna Responsabilidad por cualquier error que contenga, y reservan el derecho para alterar especificaciones sin advertencia previa.

Watson-Marlow, Bioprene en Marprene zijn gedeponeerde handelsmerken van **Watson-Marlow Limited**.

Tygon is een handelsmerk van de **Norton Company**

Waarschuwing, Deze producten zijn niet bedoeld voor gebruik in, en behoren niet te worden gebruikt voor, patient gerelateerde toepassingen.

Watson-Marlow Limited is niet aansprakelijk voor eventuele fouten in de tekst en behoudt zich het recht voor om specificaties zonder kennisgeving vooraf te wijzigen.

Watson-Marlow, Le Marprene et le Bioprene sont des marques de fabrique **Watson-Marlow Limited**

Tygon est une marque de fabrique de la **Société Norton**

Attention, Ces produits ne sont pas étudiés pour un usage interne et ne doivent pas être utilisés pour des applications en liaison directe avec les malades.

Les descriptions et caractéristiques figurant sur ce document sont données à titre d'information et non d'engagement contractuel. **Watson-Marlow Limited** se réserve le droit d'effectuer sans préavis, toute modification.

Watson-Marlow, Bioprene e Marprene são marcas comerciais da **Watson-Marlow Limited**.

Tygon é uma marca comercial de empresa **Norton**

Estes produtos não são concebidos para utilização, e não devem ser utilizados, em aplicações destinadas a doentes.

A informação que consta deste documento é, segundo cremos, correcta, mas a **Watson-Marlow** não se responsabiliza por quaisquer erros que ele possa conter e reserva-se o direito de alterar as especificações sem aviso prévio.

Watson-Marlow, Bioprene ja **Marprene** ovat **Watson-Marlow Limited** -yhtiön tavaramerkkejä.

Tygon on **Norton Company** -yhtiön tavaramerkki

Varoitus, Näitä tuotteita ei ole suunniteltu käytettäväksi eikä niitä saa käyttää sovellutuksissa, jotka on liitetty potilaaseen.

Tämän julkaisun sisältämien tietojen oletetaan olevan oikeita, mutta Watson-Marlow Ltd ei ota minkäänlaista vastuuta sen mahdollisesti sisältämistä virheistä, ja yhtiö pidättää oikeuden muutosten tekemiseen niistä etukäteen ilmoittamatta.

Watson-Marlow, Bioprene og **Marprene** er registrerte varemerker som tilhører **Watson-Marlow Limited**.

Tygon er et varemerke som tilhører selskapet **Norton**

Disse produktene må ikke brukes i forbindelse med pasientforhold, da de ikke er beregnet til den slags bruk.

Alle opplysningene i dette dokumentet menes å være korrekte, men Watson-Marlow Limited kan ikke holdes ansvarlig for eventuelle feil, og forbeholder seg retten til å forandre spesifikasjonene uten nærmere meddelelse.

Watson-Marlow, Bioprene og **Marprene** er varemærker tilhørende **Watson-Marlow Limited**.

Tygon er et varemærke tilhørende **Norton Company**

Advarsel, Disse produkter er ikke konstrueret til brug i og må ikke anvendes til patientforbundne anvendelser.

Informationerne, som dette dokument indeholder, menes at være korrekte, men Watson-Marlow Ltd påtager sig intet ansvar for evt. fejl og forbeholder sig ret til at ændre specifikationerne uden varsel.

Product Use and Decontamination Certificate

In compliance with the **UK Health & Safety at Work Act** and the **Control of Substances Hazardous to Health Regulations** you, the user are required to declare the substances which have been in contact with the product(s) you are returning to Watson-Marlow or any of its subsidiaries or distributors. Failure to do so will cause delays in servicing the product. Therefore, **please complete this form** to ensure that we have the information **before** receipt of the product(s) being returned. **A FURTHER COPY MUST BE ATTACHED TO THE OUTSIDE OF THE PACKAGING CONTAINING THE PRODUCT(S).** You, the user, are responsible for cleaning and decontaminating the product(s) before returning them.

Please complete a separate Decontamination Certificate for each pump returned.

RGA No:

1. Company

Address

..... Postcode

Telephone Fax number

2. Product

2.1 Serial number

2.2 Has the product been used?

YES		NO	
-----	--	----	--

If yes, please complete all the following Sections. If no, please complete Section 5 only

3. Details of substances pumped

3.1 Chemical names

(a)

(b)

(c)

(d)

3.2 Precautions to be taken in handling these substances

(a)

(b)

(c)

(d)

3.3 Action to be taken in the event of human contact

(a)

(b)

(c)

(d)

3.4 Cleaning fluid to be used if residue of chemical is found during servicing

(a)

(b)

(c)

(d)

Note: Please describe current faults

.....

.....

.....

4. I hereby confirm that the only substances(s) that the equipment specified has pumped or come into contact with are those named, that the information given is correct, and the carrier has been informed if the consignment is of a hazardous nature.

5. Signed

Name

Position

Date