

Watson-Marlow Alitea 114 pumpheads



Contents

1	Declaration of incorporation	2	6	Torque requirement	8
2	Safety notes	3	7	Tube holder positioning	9
3	Product specifications	4	7.1	Tube holder repositioning	10
	3.1 Dimensions	4	8	Tube loading	11
4	Good pump installation practice	5	9	Flow rates and pressure capabilities	12
	4.1 General recommendations	5	10	Tubing part numbers	14
	4.2 Do's and do not's	6	11	Trademarks	15
	4.3 Troubleshooting	6	12	Patient-connected use: warning	15
5	Pumphead mounting	7	13	Publication history	15

1 Declaration of incorporation



When this unit is to be installed into a machine or is to be assembled with other machines for installations, it must not be put into service until the relevant machinery has been declared in conformity with the Machinery Directive 2006/42/EC.

A handwritten signature in blue ink, which appears to read 'Lars Eriksson'.

September 2014

Responsible person: Lars Eriksson, General Manager, Watson-Marlow Alitea AB, Hammarby Fabriksvag 29-31, 120 33 Stockholm, Sweden.

Telephone +46 8 556 556 00. Fax +46 8 556 556 25.

The information in this user guide is believed to be correct at the time of publication. However, Watson-Marlow Alitea accepts no liability for errors or omissions. Watson-Marlow Alitea has a policy of continuous product improvement, and reserves the right to alter specifications without notice. This manual is intended for use only with the pump it was issued with. Earlier or later models may differ. The most up-to-date manuals appear on the Watson-Marlow Pumps Group website: <http://www.watson-marlow.com>

2 Safety notes

In the interests of safety, this pumphead and the tubing selected should only be used by competent, suitably trained personnel after they have read and understood this manual, and considered any hazard involved. If the product is used in a manner not specified by Watson-Marlow Ltd, the protection provided by the product may be impaired.

Any person who is involved in the installation or maintenance of this equipment should be fully competent to carry out the work. In the UK this person should also be familiar with the Health and Safety at Work Act 1974.

There are moving parts inside the pumphead. Before opening the flip top, ensure that the following safety directions are followed.

- Ensure that the pump is isolated from the mains power.
- Ensure that there is no pressure in the pipeline.
- If a tube failure has occurred, ensure that any fluid in the pumphead has been allowed to drain to a suitable vessel, container or drain.
- Protective clothing and eye protection must be worn if hazardous fluids are pumped.
- Primary operator protection from rotating parts of the pump is provided by the pumphead track.

This pump must be used only for its intended purpose.



This symbol, used on the pump or in this manual, means: Caution, refer to accompanying documents.



This symbol, used on the pump or in this manual, means: Do not allow fingers to contact moving parts.

114DV, 114DVP

3 Product specifications

114 pumpheads

This compact pumphead allows automatic tube positioning and tension in seconds, with no need for operator adjustment to achieve high accuracy and repeated precision dosing.

- For continuous tubing, 1.6mm wall
- Recommended for continuous duty
- Four-roller pumphead
- Max speed: 400 rpm continuous and 600 rpm intermittent
- Up to 340 ml/min continuous flow and up to 510 ml/min intermittent flow
- Two tube-holder positions to accept tube in bore sizes from 0.5mm to 4.8mm
- Models with occlusion settings for standard or high-pressure operation
- Universal drive connection for shafts from 6mm diameter to 10mm diameter
- Operating temp: -10° to 45°C

114D, 114DP

This manual describes the visible rotation pumpheads, 114DV and 114DVP. For versions without visible rotation: 114D—refer to 114DV; 114DP—refer to 114DVP.

114DV, 114DVP



This product does not comply with the ATEX directive and must not be used in explosive atmospheres.

3.1 Dimensions

114 pumphead

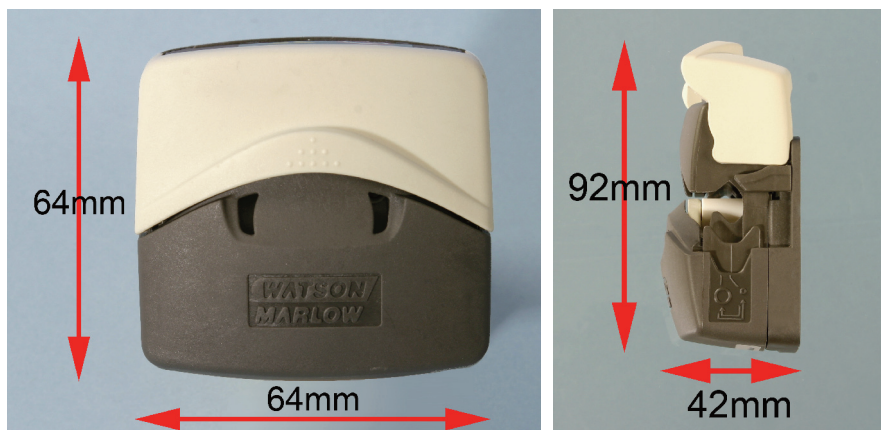

Unit weight

0.1kg

4 Good pump installation practice

114DV, 114DVP

4.1 General recommendations

A correctly engineered installation will promote long tube life.

The pump may be set up so that the direction of rotor rotation is clockwise or counter-clockwise, whichever is convenient. Please note, however, that tube life will be greater if the rotor rotates clockwise; and that performance against pressure will be maximised if the rotor rotates counter-clockwise.

Peristaltic pumps are self-priming and self-sealing against backflow. No valves are required in inlet or discharge lines, except as described below. Valves in the process flow must be opened before the pump operates. Users are advised to fit a pressure relief device between the pump and any valve on the discharge side of the pump to protect against damage caused by accidental operation with the discharge valve closed.

4.2 Do's and do not's

Do not build a pump into a tight location without adequate airflow around the pump.

Do keep delivery and suction tubes as short and direct as possible - though ideally not shorter than 0.5m - and follow the straightest route. Use bends of large radius: at least four times the tubing diameter. Ensure that connecting pipework and fittings are suitably rated to handle the predicted pipeline pressure. Try to avoid pipe reducers and lengths of smaller bore tubing than the pumphead section, **particularly in pipelines on the suction side**. Any valves in the pipeline (not usually needed with a self-priming peristaltic pump) must not restrict the flow. Any valves in the flow line must be open when the pump is running.

Do use suction and delivery pipes equal to or larger than the bore of the tube in the pumphead. When pumping viscous fluids use pipe runs with a bore several times larger than the pump tube.

Do ensure that on longer tube runs at least 0.5m of smooth bore flexible tubing is connected to the inlet and discharge port of the pumphead to help to minimise impulse losses and pulsation in the pipeline. This is especially important with viscous fluids and when connecting to rigid pipework.

Do site the pump at or just below the level of the fluid to be pumped if possible. This will ensure flooded suction and maximum pumping efficiency.

Do keep the pumphead track and all moving parts clean and free from contamination and debris.

Do run at slow speed when pumping viscous fluids. Flooded suction will enhance pumping performance in all cases, particularly for materials of a viscous nature.

Do recalibrate after changing pump tubes, fluid, or any connecting pipework. It is also recommended that the pump is recalibrated periodically to maintain accuracy.

Tube selection: The chemical compatibility lists published in Watson-Marlow publications are guides. If in doubt about the compatibility of a tube material and the duty fluid, request a Watson-Marlow tube sample card for immersion trials.

4.3 Troubleshooting

If the pump runs but there is little or no flow, make the following checks:

- Check that the tube is in the pumphead.
- Check that fluid is supplied to the pump.
- Check that the tube is not split or burst.
- Check for any kinks or blockages in the lines.
- Check that any valves in the lines are open.
- Check that the correct wall-thickness tube is being used.
- Check direction of rotation.

5 Pumphead mounting

- Lift the flip top until fully open.
- Mount the pumphead on its supporting plate through the holes indicated below, using two Allen-key headed M4 screws, length equal to 5mm + the thickness of the mount. Tighten them to a maximum of 0.5Nm.

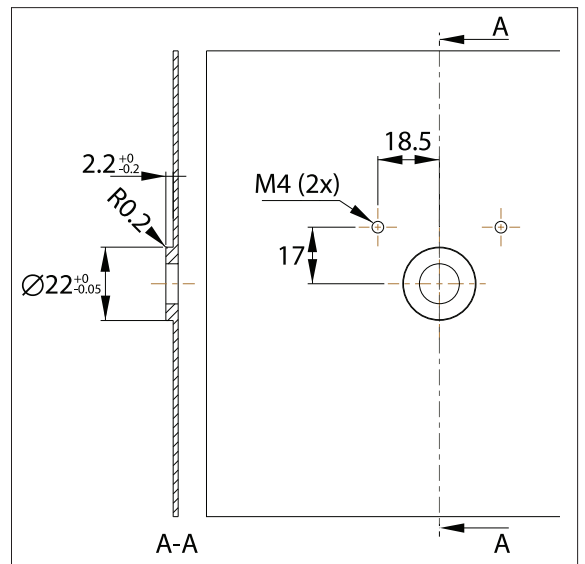
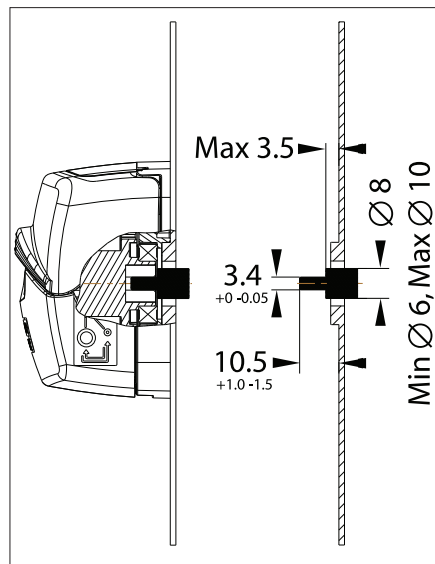
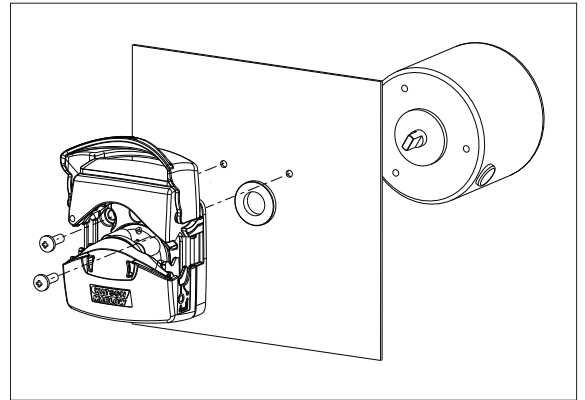
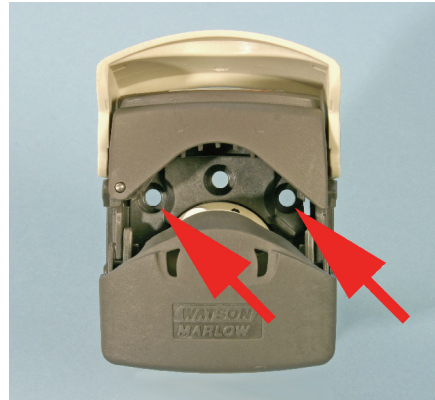

Drive shafts 8mm in diameter are recommended, but shafts from 6mm diameter to 10mm diameter are acceptable.

6 Torque requirement

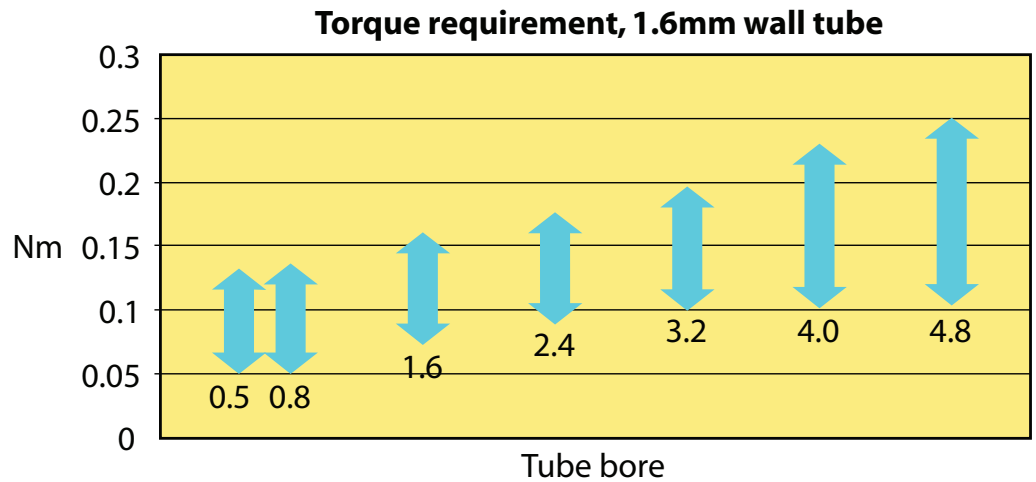

Required torque depends on many parameters. The chart above includes standard materials, direction, occlusion setting, pressure and running temperature.

Starting torques are approximately the above figures x 2.

Assess your application's torque requirement from the top of the arrows if all the parameters listed are those requiring more torque, as shown in the graph below, or to be sure to have sufficient torque for all conditions; use the bottom of the arrows if all the parameters listed are those requiring less torque, as shown in the graph below.

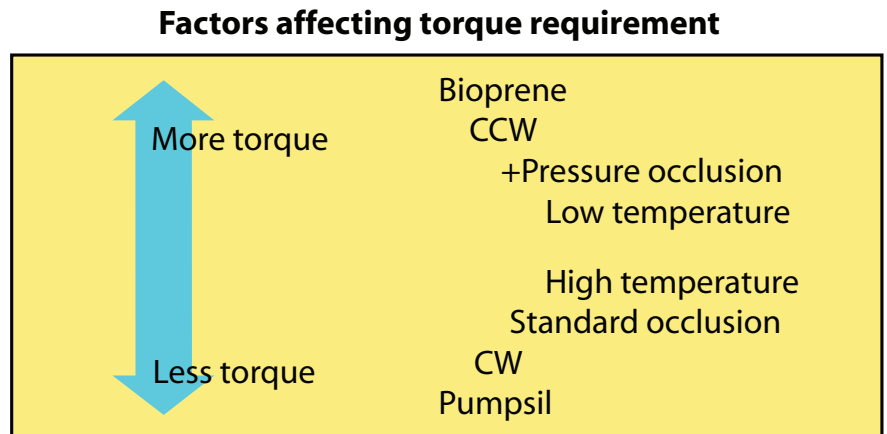

7 Tube holder positioning

The pumphead can be adjusted to accommodate 1.6mm wall tubing in sizes from 0.5mm bore to 4.8mm bore.

Tube holder position

Tube bore size	0.5mm	0.8mm	1.6mm	2.4mm	3.2mm	4.0mm	4.8mm
Inner 	✓	✓	✓	✓	✓	✗	✗
Outer 	✗	✗	✗	✓	✓	✓	✓

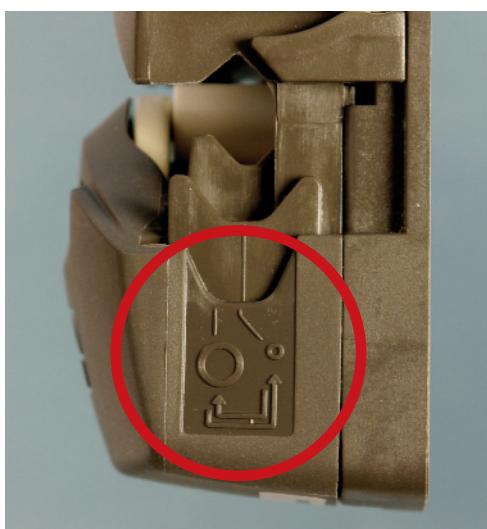

Inner position, for small tubing

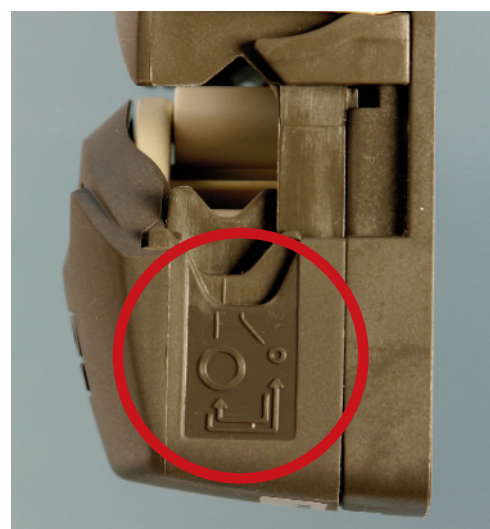

Outer position, for large tubing

With the smaller bore tubes of 0.5mm, 0.8mm and 1.6mm the inner position must be used to prevent the risk of tube slipping through the clamps and wandering across the rollers causing premature tube rupture.

With the larger bore tubes of 4.0mm and 4.8mm the outer position must be used to prevent the flow rate being excessively reduced.

For tubing bores of 2.4mm and 3.2mm either setting may be used, as appropriate for the application. The inner setting will clamp the tube harder, reducing tube slip but has the potential to marginally reduce flow rate. The outer setting will optimise flow rate but the risk of tube slip is increased.

7.1 Tube holder repositioning

○ → ● To change from the large tube to the small tube setting

Switch off the pump before changing the tube holder position. Use a pointed device such as a ball-point pen to reposition the lower tube holders **on both sides** of the pumphead.



- Lift the flip top until fully open.
- Place the pointed device pointing down into the small depression pictured here.

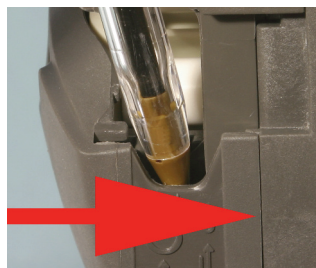
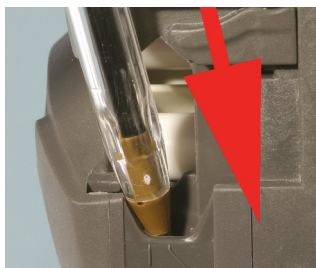

- Press down and slightly away from the front of the pumphead, as shown in the first picture above.
- Maintain the angled downward pressure and push away from the front of the pumphead. The jaw clicks into a new position.
- Release the pressure. The jaw rises into its correct alignment. If it does not rise, repeat the procedure, being sure to maintain downward pressure until release.
- Adjust the tube holder on the other side of the pumphead in the same way.

● → ○ To change from the small tube to the large tube setting

Carry out the procedure described above, but pushing towards the front of the pumphead.

Note: The pictures on the previous page show the tube holders' correct positions for small and large tubing. If a tube holder is not vertical relative to the body of the pumphead, it is wrongly positioned. Follow the instructions above to reposition it.

8 Tube loading



Switch off the pump before tube loading.

Check that the tube holders on both sides of the pumphead are correctly set for the size of tube you are using.

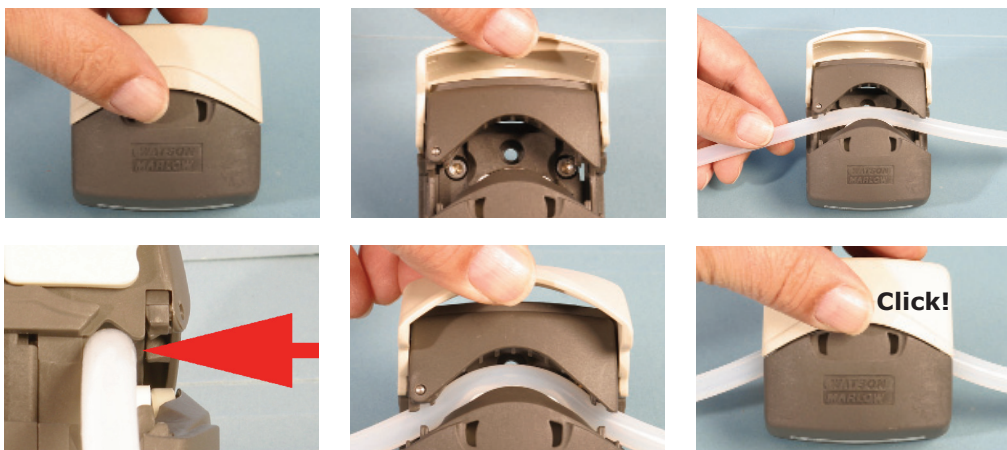

- Lift the flip top until fully open.
- Select enough tube length for the curve of the pump track. Place the tube between the rotor rollers and the track, pressed against the pumphead inner wall. The tube must not be twisted or stretched against the rollers.
- Lower the flip top until it clicks into its fully closed position. The track closes automatically and the tube is stretched correctly as it does so.

9 Flow rates and pressure capabilities

Pumping conditions

For precise and repeatable performance it is important to determine flow rates under operating conditions for each new piece of tubing.

114 pumpheads' flow rates are the same whether rotating clockwise (cw) or counter-clockwise (ccw). Their pressure capabilities vary depending on rotation sense.

114, cw and ccw rotation: Flow rates, ml/min							
Tube bore size	0.5mm	0.8mm	1.6mm	2.4mm	3.2mm	4.0mm	4.8mm
ml/rev	0.02	0.04	0.14	0.29	0.47	0.67	0.85
30 rpm	0.7	1.3	4.2	8.7	14	20	25.5
60 rpm	1.4	2.6	8.4	17.5	28.5	40.5	51
100 rpm	2.2	4.3	14	29	47.5	67	85
190 rpm	4.3	8.2	26.5	55	90.5	128	160
200 rpm	4.6	8.6	28	58	95	135	170
350 rpm	8.0	15	49	100	165	235	300
400 rpm	9.1	17	56	115	190	270	340
600 rpm	13.5	26	84	175	285	405	510

Flow rate tests were carried out using water at zero suction pressure and Bioprene tubing, with the pumphead rotating cw. Actual flow rates achieved may vary because of changes in temperature, viscosity, inlet and discharge pressures, system configuration and tubing performance against time. Flow rates may also vary due to normal manufacturing tolerances of the tubing.

Reduce the flow rates quoted by 10% if using Pumpsil tubing.

Recommended tubing

114DV

114DV: Bioprene, Marprene, Pumpsil, STA-PURE PCS and STA-PURE PFL (formerly CHEM-SURE).

114DVP

114DVP: Bioprene, Marprene, Pumpsil, STA-PURE PCS, STA-PURE PFL (formerly CHEM-SURE), PVC and Neoprene.

Pressure and flow performance curves

114DV

114DV, standard occlusion

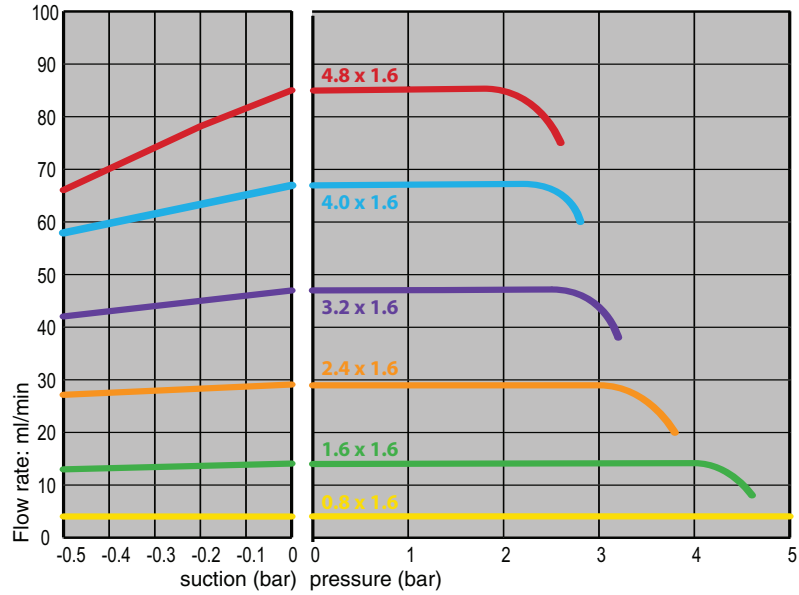

Marprene tubing, 1.6mm wall, 100 rpm, CCW rotation

114DVP

114DVP, +Pressure occlusion

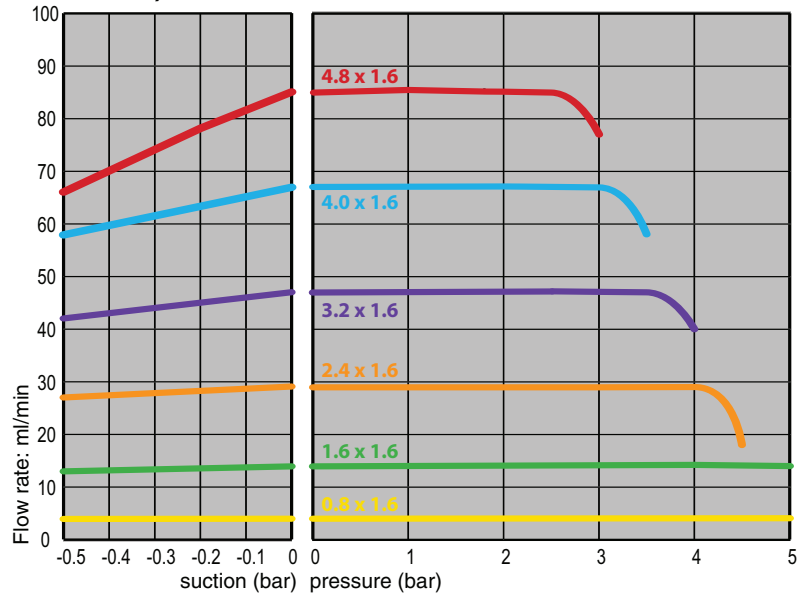

Marprene tubing, 1.6mm wall, 100 rpm, CCW rotation

114DV, 114DVP

Pressure tests were carried out using water at constant delivery pressure. Actual pressures achieved may vary because of actual tube dimensions, changes in temperature, viscosity, system configuration and tubing performance against time.

Direction of rotation

CCW: The pressure / flow curves above show performance in counter clockwise rotation. This direction is recommended for pressure applications.

CW: Clockwise rotation optimizes the pump performance regarding tube life and required torque. Clockwise rotation is recommended for low or no pressure applications. Suction performance and flow are the same as for CCW rotation.

10 Tubing part numbers

1.6mm wall tubing for 114 pumpheads

mm	#	Marprene	Bioprene	Pumpsil
0.5	112	902.0005.016	933.0005.016	913.A005.016
0.8	13	902.0008.016	933.0008.016	913.A008.016
1.6	14	902.0016.016	933.0016.016	913.A016.016
2.4		902.0024.016	933.0024.016	913.A024.016
3.2	16	902.0032.016	933.0032.016	913.A032.016
4.0			933.0040.016	
4.8	25	902.0048.016	933.0048.016	913.A048.016
mm	#	Tygon E3603*		Neoprene*
0.8	13			920.0008.016
1.6	14	E3603.016.16		920.0016.016
3.2	16	E3603.032.16		920.0032.016
4.0		E3603.040.16		
4.8	25	E3603.048.16		920.0048.016
mm	#	STA-PURE PCS	STA-PURE PFL	
1.6	14	960.0016.016	965.0016.016	
3.2	16	960.0032.016	965.0032.016	
4.8	25	960.0048.016	965.0048.016	

* Recommended for 114DVP +Pressure pumpheads only

114DV, 114DVP

11 Trademarks

Bioprene, LoadSure, Marprene, Pumpsil and **Watson-Marlow** are trademarks of Watson-Marlow Limited.

Tygon is a trademark of Saint Gobain Corporation

STA-PURE PFL and **STA-PURE PCS** are trademarks of W.L.Gore and Associates.

114DV, 114DVP

12 Warning not to use pumps in patient-connected applications

Warning These products are not designed for use in, and should not be used for patient-connected applications.

114DV, 114DVP

13 Publication history

m-114pumphead-gb-03.qxp: Watson-Marlow 114 pumphead.
Revised 09 14.