

Addition to the user manual for Certa pumps with ATEX certification



Contents

1 Addition to the user manual for Certa pumps with ATEX certification	2
1.1 Bearings maintenance	2
1.2 Safety signs	2
1.3 Device classification	2
1.4 Zonation	2
1.5 Classification of Ex-atmospheres	2
1.6 Ignition protection type	2
1.7 Temperature classes	2
1.8 Possible pump orientations	3
1.9 Technical data	3
1.10 Grounding of the pump	3
1.11 Flushing the seal system	4
1.12 Material properties	4
1.13 Pressure conditions	4
1.14 Temperature conditions	4
1.15 Maintenance and repair	4
1.16 Cleaning the pump	4
1.17 Products	4
1.18 Coupling	4
1.19 Drive	4
1.20 Oil change	5

1 Addition to the user manual for Certa pumps with ATEX certification

The Watson-Marlow MasoSine Certa pumps, which find their application in potentially explosive mixtures, are factory-equipped. The pump-specific ATEX designation can be found on the nameplate of the pump.

1.1 Bearings maintenance

Please refer to the intervals in hours specified in the operating instructions after which the bearings must be replaced.

1.2 Safety signs

The following ATEX symbols are given as an example only. The specific ATEX classification is indicated on the nameplate and the type examination certificate of the respective pump.

Example

 **II 2G Ex h IIA T4 Gb X / II 2G Ex h IIC T4 Gb X**

 **II 2G Ex h IIA T4 Gb X / II 2G Ex h IIIC T135°C Db X**



Grounding symbol

1.3 Device classification

The pumps are designed exclusively for use above ground, and are therefore related to device group II - application area "other dust. - or gas. - Ex areas "!

1.4 Zonation

The Watson-Marlow MasoSine Certa pumps can be used in Zone 1/21 of explosive areas. This corresponds to category 2G / D.



The use of the pump (s) in Zone 0 is therefore expressly prohibited!

1.5 Classification of Ex-atmospheres

Ex-atmospheres are differentiated into gas and dust. The designation abbreviates the atmosphere to G (gas) and D (dust).



The Watson-Marlow MasoSine Certa pumps are designed only for Ex-atmosphere G (gas) or D (dust)!

1.6 Ignition protection type

In accordance with the standard for "non-electrical equipment" for use in potentially explosive atmospheres" EN ISO 80079-37, the type of protection "c" for constructive safety applies to Watson-Marlow MasoSine Certa pumps.

1.7 Temperature classes

Watson-Marlow MasoSine Certa pumps with ATEX certification are only suitable for product temperatures up to **max. 94° / 201°F**:

Pump: Certa 100 **Gate-Material:** WRP, PA and MWR

 **II 2G Ex h IIC T4 Gb X / II 2G Ex h IIC T4 Gb X**

 **II 2G Ex h IIC T4 Gb X / II 2G Ex h IIIC T135°C Db X**

Pump: Certa 200 **Gate-Material:** WRP

 **II 2G Ex h IIB T4 Gb X / II 2G Ex h IIC T4 Gb X**

 **II 2G Ex h IIB T4 Gb X / II 2G Ex h IIIC T135°C Db X**

Pump: Certa 250, 300, 400, 500, 600 **Gate-Material:** WRP

 **II 2G Ex h IIA T4 Gb X / II 2G Ex h IIC T4 Gb X**

 **II 2G Ex h IIA T4 Gb X / II 2G Ex h IIIC T135°C Db X**

Pump: Certa 200, 250, 300, 400 **Gate-Material:** PA and MWR

 **II 2G Ex h IIB T4 Gb X / II 2G Ex h IIC T4 Gb X**

 **II 2G Ex h IIB T4 Gb X / II 2G Ex h IIIC T135°C Db X**

Pump: Certa 500, 600 **Gate-Material:** PA

 **II 2G Ex h IIA T4 Gb X / II 2G Ex h IIC T4 Gb X**

 **II 2G Ex h IIA T4 Gb X / II 2G Ex h IIIC T135°C Db X**

The specific ATEX classification is given on the type examination certificate and on the nameplate of the respective pump.

1.8 Possible pump orientations

With the possible nozzle positions 02-04 and 08-10, there is the possibility of creating an explosive atmosphere in the pump head, since the pump can be completely emptied.



A pump orientation in which the pump can completely empty itself should be avoided in Ex-atmospheres.

1.9 Technical data

The limit values of the pump (max speed, max pressure) are indicated on the nameplate. These limits must never be exceeded! This takes especially effect when using a frequency converter.

If the pump is supplied without a drive, the following values apply to the temperatures:

	C100	C200	C250	C300	C400	C500	C600
Max-Producttemperature *	94°C / 201 F	94°C / 201 F	94°C / 201 F	94°C / 201 F	94°C / 201 F	94°C / 201 F	94°C / 201 F
Ambient temperature	-12°C (10.4 F) to +40°C (104 F)	-12°C (10.4 F) to +40°C (104 F)	-12°C (10.4 F) to +40°C (104 F)	-12°C (10.4 F) to +40°C (104 F)	-12°C (10.4 F) to +40°C (104 F)	-12°C (10.4 F) to +40°C (104 F)	-12°C (10.4 F) to +40°C (104 F)

1.10 Grounding of the pump

Certa pumps for explosive atmospheres are equipped with a grounding screw. Ground the pump with a grounding wire that is fixed in place. In addition to grounding the pump, a grounding must also be made on the drive! Without grounding the drive, the entire pump set must not be put into operation. This is especially important in hazardous areas.

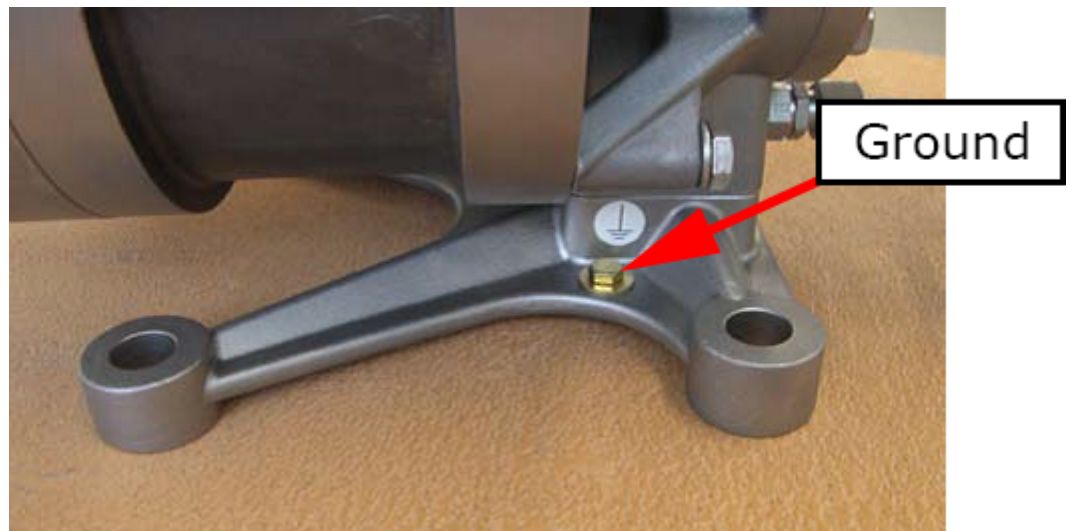

In addition to the pump, the drive and the baseplate must be grounded. If the drive and baseplate are not grounded, do not operate the pump.

1.11 Flushing the seal system

In order to prevent the formation of an explosive atmosphere in the flushing area behind the sealing system, a flush must be connected to the mechanical sealing system of the pump.

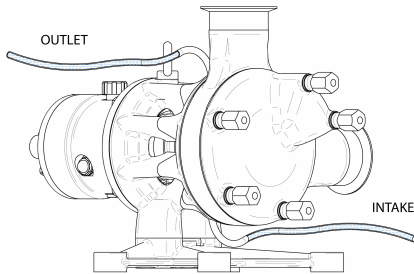

dynamic flushing



static flushing

It is possible to connect a dynamic or a static flush to the Watson-Marlow MasoSine Certa pumps. Further information can be found in the operating manual of the pump



In addition to the pump, the drive and the baseplate must be grounded. If the drive and baseplate are not grounded, do not operate the pump.

1.12 Material properties

Plastic parts installed in the pump are more sensitive to temperature changes than stainless steel parts. Therefore, the given max. product temperature (T_m) for which the pump is designed, must not be exceeded. At temperatures above 100 °C (e.g. steam sterilization) consult Watson-Marlow MasoSine.

1.13 Pressure conditions

Valves in the process flow must be opened before the pump operates. Users are advised to fit a pressure relief device between the pump and any valve on the discharge side of the pump to protect against damage caused by accidental operation with the discharge valve closed.

1.14 Temperature conditions

A temperature monitor on the discharge nozzle of the pump is to be installed to prevent a temperature increase over the temperature class, for example due to compression of the product.

1.15 Maintenance and repair

- For safety reasons, the pump may only be filled outside the Ex area. All tools must be ATEX-suitable.
- Keep the pump set dust-free to prevent dust from smoldering.
- Flushing channels in the bearing frame must always be free of blockages and cleaned if necessary.

1.16 Cleaning the pump



Use only cleaning agents suitable for the application to clean the pump, as this may result in an uncontrollable explosive atmosphere.

1.17 Products

Carbon disulfide compounds and chemicals with an ignition temperature below 120°C must not be pumped.

1.18 Coupling

If the pump is used in a potentially explosive atmosphere, only an elastic, interlocking coupling with ATEX approval must be used between the pump and the drive. Chains, gear belts, V-belts or similar devices that bring radial forces to the bearings must not be used.

1.19 Drive

Reduction gears in the drive chain and the control units must be ATEX certified. Internal combustion engines may under no circumstances be used.

Install frequency inverters outside potentially explosive atmospheres or with the appropriate ATEX certification. In any case, the frequency converter must have the characteristics required for operation in potentially explosive atmospheres: temperature monitoring, speed limiters, etc.

1.20 Oil change



The oil sight glass (B) on the bearing housing must be checked daily before using the pump for damage and sufficient oil in the bearing block. The oil should reach approximately to the middle of the sight glass.

- Make sure that the drain plug C is present and tightened.
- Unscrew the vent valve A and fill the support unit with suitable oil up to the mark (see note below).
- Close vent valve A.
- Check oil level at sight glass B. The oil level must not fall below the middle line of the sight glass.

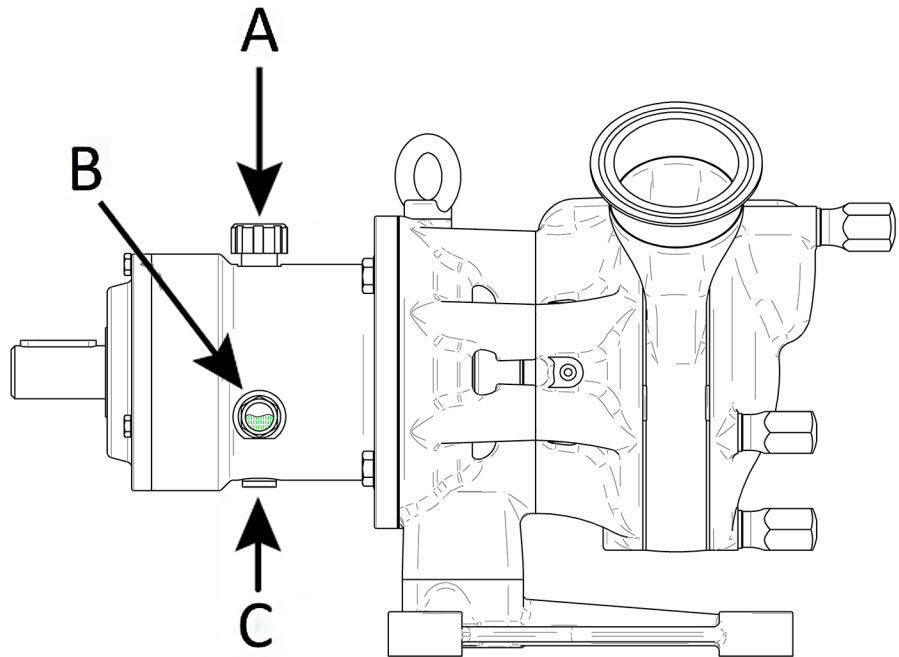

Note: If the pump is used under ATEX conditions, in place of the oil sight glass, a plug can be screwed in.

Note: New pumps are factory-filled with Klüberoil 4 UH 1- 220 N for the food and pharmaceutical industries, suitable for process temperatures between -30°C (-22F) and 120°C (248F).



If the pump is intended for use in an area to ATEX regulations, only this oil must be used.

For information on filling volumes of the pump, please refer to the operating instructions.

Note: Waste oil must be disposed of in accordance with local regulations.

Note: The oil must be changed at least once a year.