

Watson-Marlow 323E, 323S, 323U and 323Du pumps



Contents

1	Declaration of conformity	2	23.3	313D and 314D pumphead order codes	34
2	Declaration of incorporation	2	23.4	313D and 314D flow rates	35
3	Two-year warranty	3	23.5	313D and 314D: maximum number of pumpheads	36
4	When you unpack your pump	4	23.6	313D and 314D: tubing part numbers	37
5	Information for returning pumps	5	23.7	314MC and 318MC microcassette pumpheads	38
6	Peristaltic pumps: an overview	6	23.8	314MC and 318MC microcassette pumphead spares	40
7	Safety notes	7	23.9	314MC and 318MC flow rates	41
8	Pump specifications	9	23.10	314MC and 318MC tubing part numbers	42
8.1	Pump features	9	23.11	501RL pumphead	43
8.2	Dimensions	14	23.12	501RL and 501RL2 installation	43
9	Good pump installation practice	15	23.13	501RL and 501RL2 tube loading	43
9.1	General recommendations	15	23.14	501RL and 501RL2 rotor settings	44
9.2	Do's and do not's	16	23.15	501RL and 501RL2 pumphead spares	45
10	Connecting this product to a power supply	17	23.16	501RL and 501RL2 flow rates	46
11	Start-up check list	18	23.17	501RL and 501RL2 tubing part numbers	46
12	Switching the pump on	18	24	Trademarks	47
13	Auto-restart facility	19	25	Warning not to use pumps in patient-connected applications	47
14	Manual operation	20	26	Publication history	47
15	Keypad lock	21	27	Decontamination certificate	48
16	MemoDose	22			
17	Automatic operation with analogue signals, remote control or RS232 link	23			
17.1	Analogue signals and remote control	24			
17.2	RS232 serial link	24			
18	Care and maintenance	26			
19	Troubleshooting	28			
19.1	Error messages	28			
20	Drive maintenance	29			
21	Drive part numbers	30			
22	Drive spares	30			
23	Pumpheads	31			
23.1	Pumpheads: key safety information	32			
23.2	313D and 314D pumpheads	32			

E, S, U, Du

1 Declaration of conformity

Printed conformance documents are supplied within product packaging.

E, S, U, Du

2 Declaration of incorporation

Available on request

3 Two-year warranty

Watson-Marlow Limited ("Watson-Marlow") warrants, subject to the conditions and exceptions below, through either Watson-Marlow, its subsidiaries, or its authorised distributors, to repair or replace free of charge, any part of the product which fails within two years of the day of manufacture of the product. Such failure must have occurred because of defect in material or workmanship and not as a result of operation of the product other than in normal operation as defined in this pump manual.

Watson-Marlow shall not be liable for any loss, damage, or expense directly or indirectly related to or arising out of the use of its products, including damage or injury caused to other products, machinery, buildings, or property, and Watson-Marlow shall not be liable for consequential damages, including, without limitation, lost profits, loss of time, inconvenience, loss of product being pumped, and loss of production. This warranty does not obligate Watson-Marlow to bear any costs of removal, installation, transportation, or other charges which may arise in connection with a warranty claim.

Conditions of and specific exceptions to the above warranty are:

Conditions

- Products must be returned by pre-arrangement, carriage-paid, to Watson-Marlow, or a Watson-Marlow approved service centre.
- All repairs or modifications must have been made by Watson-Marlow Limited, or a Watson-Marlow approved service centre or with the express permission of Watson-Marlow.
- Warranties purporting to be on behalf of Watson-Marlow made by any person, including representatives of Watson-Marlow, its subsidiaries, or its distributors, which do not accord with the terms of this warranty shall not be binding upon Watson-Marlow unless expressly approved in writing by a Director or Manager of Watson-Marlow.

Exceptions

- The warranty shall not apply to repairs or service necessitated by normal wear and tear or for lack of reasonable and proper maintenance.
- All tubing and pumping elements as consumable items are excluded.
- Products which, in the judgment of Watson-Marlow, have been abused, misused, or subjected to malicious or accidental damage or neglect are excluded.
- Electrical surge as a cause of failure is excluded.
- Chemical attack is excluded
- All pumphead rollers are excluded.
- Pumpheads from the 313/314 retain their one-year standard pumphead warranty. The drive they are attached to is subject to the two-year warranty as set out here.
- Ancillaries such as leak detectors are excluded.

4 When you unpack your pump

Unpack all parts carefully, retaining the packaging until you are sure all components are present and in good order. Check against the components supplied list, below.

Packaging disposal

Dispose of packaging materials safely, and in accordance with regulations in your area. The outer carton is made of corrugated cardboard and can be recycled.

Inspection

Check that all components are present. Inspect components for damage in transit. If anything is missing or damaged, contact your distributor immediately.

Components supplied

Watson-Marlow 323E, 323S, 323U and 323Du pumps are supplied as:

- Dedicated 323E, 323S, 323U or 323Du pump drive unit fitted with one or more 313 or 314 pumpheads (see 8 *Pump specifications*).
- The designated mains power lead for your pump
- Compliance documentation
- Safety information documentation

Note: Some versions of this product will include components different from those listed above. Check against your purchase order.

Storage

This product has an extended shelf life. However, care should be taken after storage to ensure that all parts function correctly. Users should be aware that the pump contains a battery with an unused life of seven years. Long-term storage is not recommended for peristaltic pump tubing. Please observe the storage recommendations and use-by dates which apply to tubing you may wish to bring into service after storage.

5 Information for returning pumps

Equipment which has been contaminated with, or exposed to, body fluids, toxic chemicals or any other substance hazardous to health must be decontaminated before it is returned to Watson-Marlow or its distributor.

A certificate included at the rear of these operating instructions, or signed statement, must be attached to the outside of the shipping carton. This certificate is required even if the pump is unused. See 27 *Decontamination certificate*.

If the pump has been used, the fluids that have been in contact with the pump and the cleaning procedure must be specified along with a statement that the equipment has been decontaminated.

6 Peristaltic pumps - an overview

Peristaltic pumps are the simplest pump, with no valves, seals or glands to clog or corrode. The fluid contacts only the bore of a tube, eliminating the risk of the pump contaminating the fluid, or the fluid contaminating the pump. Peristaltic pumps can run dry.

How they work

A compressible tube is squeezed between a roller and a track on an arc of a circle, creating a seal at the point of contact. As the roller advances along the tube, the seal also advances. After the roller has passed, the tube returns to its original shape, creating a partial vacuum which is filled by fluid drawn from the inlet port.

Before the roller reaches the end of the track, a second roller compresses the tube at the start of the track, isolating a packet of fluid between the compression points. As the first roller leaves the track, the second continues to advance, expelling the packet of fluid through the pump's discharge port. At the same time, a new partial vacuum is created behind the second roller into which more fluid is drawn from the inlet port.

Backflow and siphoning do not occur, and the pump effectively seals the tube when it is inactive. No valves are needed.

The principle may be demonstrated by squeezing a soft tube between thumb and finger and sliding it along: fluid is expelled from one end of the tube while more is drawn in at the other.

Animal digestive tracts function in a similar way.

Suitable applications

Peristaltic pumping is ideal for most fluids, including viscous, shear-sensitive, corrosive and abrasive fluids, and those containing suspended solids. They are especially useful for pumping operations where hygiene is important.

Peristaltic pumps operate on the positive displacement principle. They are particularly suitable for metering, dosing and dispensing applications. Pumps are easy to install, simple to operate and inexpensive to maintain.

7 Safety notes

In the interests of safety, this pump and the tubing selected should only be used by competent, suitably trained personnel after they have read and understood this manual, and considered any hazard involved. If the pump is used in a manner not specified by Watson-Marlow Limited, the protection provided by the pump may be impaired.



This symbol, used on the pump and in this manual, means: Caution, refer to accompanying documents.



This symbol, used on the pump and in this manual, means: Do not allow fingers to contact moving parts.



This symbol, used on the pump and in this manual, means: Recycle this product under the terms of the EU Waste Electrical and Electronic Equipment (WEEE) Directive.



There is a user-replaceable type T1.0AH 250V fuse in the fuse drawer of the IEC mains connector at the back of the pump, which also contains a spare fuse. In some countries, the mains power plug contains an additional replaceable fuse. There are no user-serviceable fuses or parts inside this pump.



Fundamental work with regard to lifting, transportation, installation, starting-up, maintenance and repair should be performed by qualified personnel only. The unit must be isolated from mains power while work is being carried out.

Any person who is involved in the installation or periodic maintenance of this equipment should be suitably skilled or instructed and supervised using a safe system of work. In the UK this person should also be familiar with the Health and Safety at Work Act 1974.

There are moving parts inside the pumphead. Before opening the track, ensure that the following safety directions are followed.

- Ensure that the pump is isolated from the mains power.
- Ensure that there is no pressure in the pipeline.
- If a tube failure has occurred, ensure that any fluid in the pumphead has been allowed to drain to a suitable vessel, container or drain.
- Ensure that protective clothing and eye protection are worn if hazardous fluids are pumped.
- Primary operator protection from rotating parts of the pump is provided by the pumphead track. See 23 *Pumpheads*.



This product does not comply with the ATEX directive and must not be used in explosive atmospheres.

This pump must be used only for its intended purpose. The pump must be accessible at all times to facilitate operation and maintenance. Access points must not be obstructed or blocked. The pump's mains plug is the disconnecting device (for isolating the motor drive from the mains supply in an emergency). Do not position the pump so that it is difficult to disconnect the mains plug. Do not fit any devices to the drive unit other than those tested and approved by Watson-Marlow. Doing so could lead to injury to persons or damage to property for which no liability can be accepted.

If hazardous fluids are to be pumped, safety procedures specific to the particular fluid and application must be put in place to protect against injury to persons.

The exterior surfaces of the pump may get hot during operation. Do not take hold of the pump while it is running. Let it cool after use before handling it.

No attempt should be made to run the drive without a pumphead fitted.

8 Pump specifications

Labels fixed to the rear of the pump contain manufacturer and contact details, product reference number, serial number and model details.

8.1 Pump features

Features	323E	323S	323U	323Du
Manual control	•	•	•	•
Backlight	•	•	•	•
Beeper	•	•	•	•
Manual screen: rpm	•	•	•	•
15-400 rpm 27:1 speed control	•			
3-400 rpm 133:1 speed control		•	•	•
1.5-220 rpm 147:1 speed control		•	•	•
5 rpm scrolling increment	•			
1 rpm scrolling increment		•	•	•
Auto-restart		•	•	•
Keypad lock		•	•	•
MemoDose		•	•	•
Analogue input: 4-20mA, 0-10V			•	•
Remote stop/start control			•	•
Remote direction control			•	•
RS232 control				•
313D and 314D pumpheads	•	•	•	•
501RL and 501RL2 pumpheads		•	•	•
314MC and 318MC pumpheads		•	•	•
~100-120V/~220-240V operation	•	•	•	•
IP31 wipe-down case	•	•	•	•

Four models of 323 drives are documented in this manual: 323E, 323S, 323U and 323Du, with varying functionality, as described earlier in this section. The 323E is fitted with a short-nosed gearbox, offers 15-400 rpm, and can be fitted with a 313 or 314 pumphead. The 323S, 323U and 323Du are available with a choice of gearboxes: a short-nosed gearbox, which offers 3-400 rpm and can be fitted with a 313 or 314 pumphead, or a 314MC or a 318MC pumphead; and a long-nosed gearbox, which offers 1.5-220 rpm and can be fitted with a 501RL or a 501RL2 pumphead. See 23 *Pumpheads*.

323E	323S, 323U, 323Du		
15-400 rpm	3-400 rpm	1.5-220 rpm	
Short-nosed gearbox	Short-nosed gearbox	Long-nosed gearbox	
313D 313D2 313X 313X2 314D 314D2 314X 314X2	313D 313D2 313X 313X2 314MC 314MCX 318MC 318MCX	501RL 501RL2	
314MC, 318MC 501RL	501RL	314MC, 318MC 313D, 314D	
323E	323S	323U	323Du

IP (Ingress Protection) and NEMA definitions

IP		NEMA
1st Digit	2nd Digit	
3 Protected against ingress of solid objects with a diameter of more than 2.5mm. Tools, wires etc with a thickness of more than 2.5mm are prevented from approach	1 Protection against dripping water falling vertically. No harmful effect must be produced	2 Indoor use to provide a degree of protection against limited amounts of falling water and dirt
5 Protected against harmful dust deposits. Ingress of dust is not totally prevented but the dust must not enter in sufficient quantity to interfere with satisfactory operation of the equipment. Complete protection against contact	5 Protection against water projected from a nozzle against the equipment (enclosure) from any direction. There must be no harmful effect (water jet)	12 Indoor use to provide a degree of protection against dust, falling dirt and dripping, non-corrosive liquids
		13 Indoor use to provide a degree of protection against dust and spraying of water, oil and non-corrosive coolants
6 Protection against ingress of dust (dust-tight). Complete protection against contact	6 Protection against heavy seas or powerful water jets. Water must not enter the equipment (enclosure) in harmful quantities (splashing over)	4X Indoor or outdoor use* to provide a degree of protection against splashing water, wind-blown dust and rain, hose-directed water; undamaged by the formation of ice on the enclosure. (Resist corrosion: 200-hour salt spray)

* Protect from prolonged UV exposure.

Pump specifications

Supply voltage/frequency	100-120V/200-240V 50/60Hz 1ph
Maximum voltage fluctuation	±10% of nominal voltage. A well regulated electrical mains supply is required along with cable connections conforming to the best practice of noise immunity
Installation category (overvoltage category)	II
Power consumption	100VA
Full load current	<0.43A at 230V; <0.86A at 115V
Eprom version	Accessible through pump software
Enclosure rating	IP31
Environment	Indoor use only
Operating temperature range	4C to 40C, 40F to 104F
Storage temperature range	-40C to 70C, -40F to 158F
Maximum altitude	2,000m, 6,560ft
Humidity (non-condensing)	80% up to 31C, 88F, decreasing linearly to 50% at 40C, 104F
Weight	See 8.2 <i>Dimensions</i>
Noise	<70dB(A) at 1m

Standards

	Safety requirements for electrical equipment for measurement, control and laboratory use: BS EN 61010-1 incorporating A2 Category 2, Pollution degree 2
	Conducted emissions: BS EN 55011, Class A
	Radiated emissions: BS EN 55011, Class A
EC harmonised standards	Electrostatic discharge: BS EN 61000-4-2
	Radiated RF immunity: BS EN 61000-4-3
	Fast transient burst: BS EN 61000-4-4
	Surge immunity: BS EN 61000-4-5
	Conducted RF immunity: BS EN 61000-4-6
	Voltage dips and interruptions: BS EN 61000-4-11
	UL 61010A-1
Other standards	CAN/CSA-C22.2 No 61010-1
	Conducted emissions FCC 47CFR, Part 15.107
	Radiated emissions FCC 47CFR, Part 15

8.2 Dimensions in millimetres

323E/D, 323S/D, 323U/D, 323Du/D

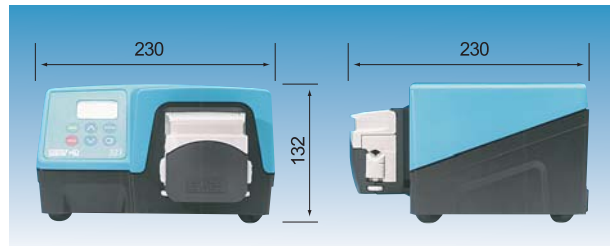

323S/MC, 323U/MC, 323Du/MC

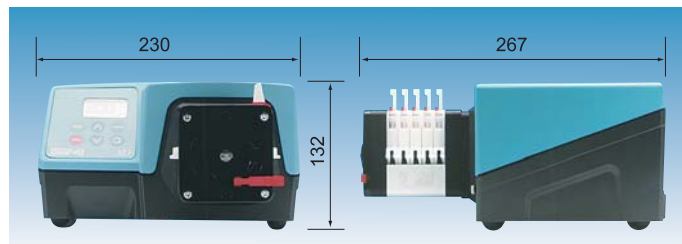

323S/RL, 323U/RL, 323Du/RL

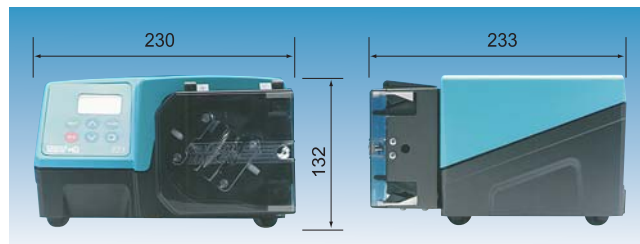

Unit weights

	Drive only	+ 313	+ 501RL
323	4.2kg, 9lb 4oz	4.5kg, 9lb 14oz	5.5kg, 12lb 2oz

9 Good pump installation practice

9.1 General recommendations

Position

A correctly engineered installation will promote long tube life. Site the pump on a flat, horizontal, rigid surface, free from excessive vibration. Allow a flow of air around the pump to ensure that heat can be dissipated. Ensure that the temperature around the pump does not exceed 40C.

Emergency disconnection

The pump's mains plug is the disconnecting device (for isolating the motor drive from the mains supply in an emergency). Do not position the pump so that it is difficult to disconnect the mains plug. The **STOP** key on the keypad will always stop the pump. However, it is recommended that a suitable local emergency stop device is fitted into the mains supply to the pump.

Valves

Peristaltic pumps are self-priming and self-sealing against backflow. No valves are required in inlet or discharge lines. Valves in the process flow must be opened before the pump operates. Users are advised to fit a pressure relief device between the pump and any valve on the discharge side of the pump to protect against damage caused by accidental operation with the discharge valve closed.

The pump may be set up so that the direction of rotor rotation is clockwise or counter-clockwise, whichever is convenient.

Tubing materials: run-in advice

Sta-Pure and Marprene tubing are hard to compress when new. When using tubing made of these materials, the first 30 seconds should be at a speed of 10 rpm or greater. If the pump is run slower, the safety system built into pump drive's software may cause it to stop and display an over-current error message.

9.2 Do's and do not's

Do observe suitable precautions for the reduction of electrostatic charge when operating/maintaining the pump, such as ESD protective workwear or conductive strapping.

Do operate the pump on a flat horizontal surface. The pump requires a free flow of air for cooling. Do not block the air vents beneath the pump or at the rear.

Do not stack pumps more than three high.

Do use only single phase mains electricity supplies.

Do keep delivery and suction tubes as short and direct as possible - though ideally not shorter than 1m - and follow the straightest route. Use bends of large radius: at least four times the tubing diameter. Ensure that connecting pipework and fittings are suitably rated to handle the predicted pipeline pressure. Avoid pipe reducers and lengths of smaller bore tubing than the pumphead section, particularly in pipelines on the suction side. When pumping viscous fluids use pipe runs with a bore several times larger than the pump tube. Any valves in the pipeline (not usually needed) must not restrict the flow. Any valves in the flow line must be open when the pump is running.

Do ensure that on longer tube runs at least 1m of smooth bore flexible tubing is connected to the inlet and discharge port of the pumphead to help to minimize impulse losses and pulsation in the pipeline. This is especially important with viscous fluids and when connecting to rigid pipework.

Do site the pump at or just below the level of the fluid to be pumped if possible. This will ensure flooded suction.

Do keep the pumphead track and all moving parts clean and free from contamination and debris.

Do run at slow speed when pumping viscous fluids. Flooded suction will enhance pumping performance in all cases, particularly for materials of a viscous nature.

Do recalibrate after changing pump tubes, fluid, or any connecting pipework. It is also recommended that the pump is recalibrated periodically to maintain accuracy.

When using Marprene or Bioprene continuous tubing, do re-tension the tube after the first 30 minutes of running.

Tube selection: The chemical compatibility lists published in Watson-Marlow publications are guides. If in doubt about the compatibility of a tube material and the duty fluid, request a Watson-Marlow tube sample card for immersion trials.

10 Connecting this product to a power supply

A well regulated electrical mains supply is required along with cable connections conforming to the best practice of noise immunity. It is not recommended to site these drives alongside "dirty" electrical mains supplies such as 3-phase contactors and inductive heaters without special attention being paid to unacceptable mains-borne noise.



The voltage selector is mounted in the switchplate at the rear of the pump. Set the voltage selector to 115V for 100-120V 50/60Hz supplies or 230V for 200-240V 50/60Hz supplies. Always check the voltage selector switch before connecting the mains supply. Make suitable connection to an earthed, single-phase mains electricity supply. To comply with Safety Standards, the mains plug must be a separable plug (not a locking type).



We recommend using commercially available supply voltage surge suppression where there is excessive electrical noise.

Input line fusing: type T1.0AH 250V 20mm time-delayed cartridge fuse, located in the combined mains IEC inlet socket and fuse drawer at the rear of the pump.

Note: A spare fuse is also provided in the drawer.

Conductor coding

	European	North American
live	brown	black
neutral	blue	white
ground	green/yellow	green

E, S, U, Du

11 Start-up check list

- Ensure that proper connections are achieved between the pump tube and suction and discharge piping.
- Ensure proper connection has been made to a suitable power supply.
- Ensure that the recommendations in section 9 Good pump installation practice are followed.
- Check the position of the voltage selector switch
- Check the mains power switch at the rear of the pump
- Check the fuse in the mains inlet socket at the rear of the pump
- Ensure that the mains IEC plug is correctly fitted in the mains IEC inlet socket

E, S, U, Du

12 Switching the pump on

- Switch on the power supply at the rear of the pump. The pump runs a power-on test to confirm proper functioning of the memory and hardware. If a fault is found, an error message is displayed. See 19 *Error messages*.
- If the pump starts running look for the ! symbol on the display. This ! symbol indicates that the pump is set for auto-restart. Press the **STOP** key if you need to stop the pump

First-time start-up defaults				
	323E	323S	323U	323Du
Direction	Clockwise	Clockwise	Clockwise	Clockwise
Pumphead, 400	313	313	313	313
Pumphead, 220		501RL	501RL	501RL
Keypad lock		Off	Off	Off
Auto-restart		Off	Off	Off
Pump status	Stopped	Stopped	Stopped	Stopped
Remote stop			Open=run	Open=run

The pump is now ready to operate according to the defaults listed above.

All operating parameters may be changed by means of key-presses. See 14 *Manual operation*.

13 Auto-restart facility

Auto-restart will restart the pump after mains power interruptions. The pump will return to its previous operating state. To install auto-restart:

- Mains power must be available to the pump to engage auto-restart.
- Stop the pump. Turn off the mains power switch at the rear of the pump.
- Hold down the **START** key and turn the mains power switch on. The ! symbol will show on the display.
- Start the pump. If the mains supply is interrupted the pump will automatically restart when the mains power returns.
- Auto-restart is retained while the pump is switched off.
- To remove auto-restart switch off the mains power at the rear of the pump. Hold down the **STOP** key and turn the mains power switch on. The ! symbol will go out.



Do not use auto-restart for more than 10 starts per hour. We recommend remote control where a high number of starts is required.

14 Manual operation

- You can adjust the speed on the display while the pump is stopped or running.
- Use the **UP** key to increase the set speed. Use the **DOWN** key to reduce the set speed. We recommend that the speed is reduced to a minimum before starting the pump.
- The 323E increments in steps of 5rpm. The 323S, 323U and 323Du increment in steps of 1rpm.
- Press the **DIRECTION** key to reverse the direction of rotation.
- The direction is shown by the rotation symbol. The direction may be changed while the pump is stopped or running.
- Start the pump with the **START** key.
- The rotation symbol will move to confirm that the pump is operating. The symbol is static when the pump is stopped.
- Stop the pump with the **STOP** key. The pump will stop immediately.
- The display will continue to show the previous speed and direction. The pump will return to this speed when the **START** key is pressed again.
- You can reduce the pump speed to 0 rpm with the **DOWN** key. The pump is still in the running state and the rotation symbol will continue to move. Press the **UP** key to return the pump to the minimum speed.

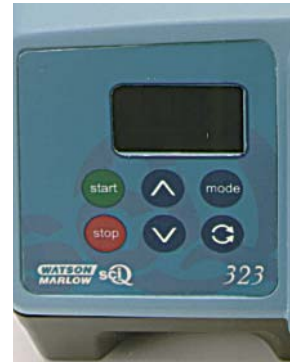

15 Keypad lock

- The keypad can be locked to prevent changes to pump speed or other settings, and make it possible only to start or stop the pump. The padlock symbol will show on the display.
- Set the pump running. Hold down the **START** key for more than 2 seconds to lock the keypad. The padlock symbol will show and only the **START** and **STOP** key will function.
- The keypad may also be locked while the pump is stopped. Hold down the **STOP** key for more than 2 seconds. The padlock symbol will show. The pump will start and stop but the speed and direction will be locked.
- To unlock the keypad while the pump is running hold down the **START** key for a further 2 seconds. The padlock symbol is removed. If the pump is stopped hold down the **STOP** key until the padlock symbol is removed.

16 MemoDose

The pump can dispense a set quantity or dose of fluid each time the key is pressed. This is the MemoDose facility.

Set the pump speed and direction. Place a suitable measuring container at the outlet and **START** the pump.



When the required volume of fluid has been dispensed, press the **STOP** key twice within half a second. This starts the MemoDose feature.

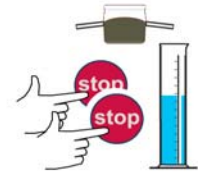

The pump has made a record of the fluid it has just dispensed. You may now repeat this dose or adjust the quantity as required. The display will show "dos" for 3 seconds. Then the display will change to show 100%.

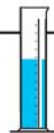
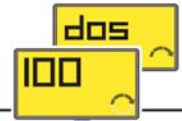

Measure the quantity of fluid which has been dispensed. If the quantity is correct press **START** to repeat the dose.

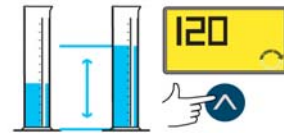
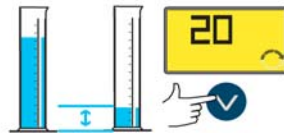

If the initial dose is larger than required use the **DOWN** key to reduce the volume % showing on the display. This will reduce the next dose to be dispensed by the pump.

If the initial dose was smaller than required use the **UP** key to increase the next dose to be dispensed by the pump.



Press **START**. The pump will dispense the new dose and the display will count down as this dose proceeds. The pump will stop when the new dose is complete.

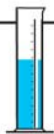

Measure the new dose. If it is correct you may now repeat this dose as often as required. The keypad lock can be used to prevent further changes.

Use the **UP** and **DOWN** keys to further adjust the dose until the correct quantity is obtained. You may adjust the dose size down to 1% or up to 999%



Press the **STOP** key twice within half a second to exit MemoDose and return to manual operation.

Notes

You must exit MemoDose to change pump speed and direction. But you may return to MemoDose and keep the present dose size. To retain the MemoDose value through a power interruption the pump must be in auto-restart.

- Press **STOP** twice to exit MemoDose and return to manual operation.
- Do not start the pump. Adjust the speed and direction showing on the display.
- Press **STOP** twice within half a second to return to MemoDose. The display will show the previous % dose size. The pump will dose at the new speed and direction.
- MemoDose doses can be triggered remotely. See 17.1 *Analogue signals and remote control*.

Always check the dose size when changing pump tubes, fluid, or any connecting pipework.

U, Du

17 Automatic operation with analogue signals, remote control, or RS232 link

The pump will normally revert to manual control when it is switched on and display the present pump speed.

Check that the pump is ready to run before selecting automatic operation. Remote control signals may start the pump without warning.

















Press the **MODE** key to select automatic operation. The pump will respond to the analogue and (323Du only) RS232 signal as soon as analogue is selected. The **UP** and **DOWN** keys will be disabled. Re-press the **MODE** key to return to manual control. The pump will return to the last set manual state, speed and direction.

In an emergency press the **STOP** key. The pump will return directly to manual control and stop.

Auto-restart will retain automatic operation while the pump is switched off.

E, S, U, Du

Mode keypress

323E, 323S	323U	323Du
 Manual speed control	 Manual speed control	 Manual speed control
		
	 Analogue control	 Analogue control
 Return to manual speed control		
 Return to manual speed control	 Return to manual speed control	 RS232 control
<p>Pressing the MODE key on 323E and 323S will display "man" for two seconds then return to current set speed</p>		
		 Return to manual speed control

17.1 Analogue signals and remote control

Pump starting and direction may be remotely controlled by switches, and speed by analogue signals, connected to the 25-way D connector at the rear of the pump. The analogue interface will accept either 0-10 VDC or 4-20 mA signals.

To select analogue operation press the **MODE** key until "ana" is showing in the display. The AUTO icon will show on the display.

Pump speed will increase with an increasing analogue signal. The pump will be stopped at 0V or 4mA. This interface is pre-calibrated at the factory and may not be altered. If the analogue signal is too high the pump will display an error message "**E21**" (Over signal). See 19 *Error messages*.

The remote stop/start input works with both manual and analogue control modes. The remote direction input works only with analogue control mode.



Never apply mains voltage to the 25-way D socket. Apply the correct signals to the pins shown below. Limit signals to the maximum values shown. Do not apply voltage across other pins. Permanent damage, not covered by warranty, may result.

Speed control

Analogue voltage signal pins 4 and 14
 Input impedance 200 kohms
 Maximum voltage signal 10V

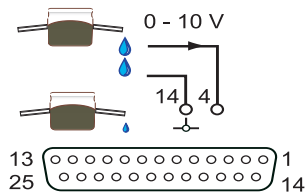

Analogue current signal pins 4 and 14
 link 3 and 15
 Input impedance 250 ohms
 Maximum current signal 20mA

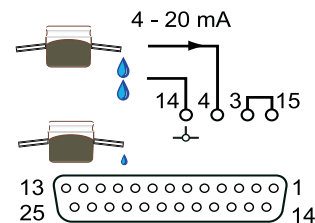

Stop/Start

A remote stop/start switch may be connected between pins 7 and 17 of the 25 pin socket. Or a TTL compatible logic signal may be applied to pin 7. (Low 0V High 5V maximum. Ground to pin 17). This is available in manual and analogue operation.

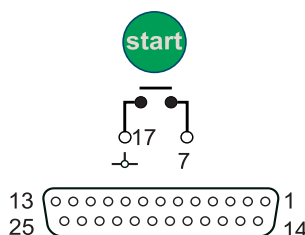

To invert the stop/start action of the switch or TTL compatible signal:

- Turn off the mains power switch at the rear of the pump.
- Hold down the **STOP** and **DIRECTION** keys. Turn on the mains power switch.
- The display will show the present signal setting; RS for factory default response or IRS for inverted signal response.
- Press the **UP** or **DOWN** key to reverse the present setting.
- Press the **START** key to set the signal response and return to manual operation.

Signal response	Switch	TTL compatible signals
Factory default (RS)	Open = start pump	High 5V = start pump
Inverted (IRS)	Open = stop pump	High 5V = stop pump

Manual operation with a remote stop/start switch

If you invert the operation of the remote stop/start switch you must connect a wire link from pin 7 to 17 to be able to start the pump from the keypad. This diagram shows the combined effects of the remote switch and the pump keypad.

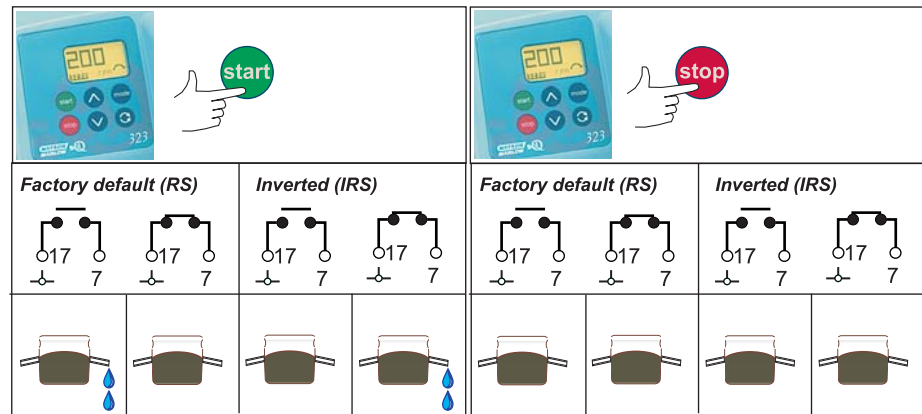

If **STOP** is pressed the remote stop/start switch will have no effect.

Direction input (analogue control mode only)

Connect remote direction switch between pins 5 and 17. Also link pins 6 and 18 to enable remote direction control. The **UP** and **DOWN** keys on the pump will be disabled. Open switch for clockwise rotation, close switch for counter-clockwise rotation. With no connection, the pump will default to clockwise rotation. Or a TTL compatible logic signal may be applied to pin 5. (Ground to pin 17). High (5V maximum) for clockwise rotation. Low (0V) for counter-clockwise rotation.

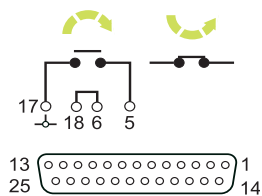

You cannot invert the remote direction signal.

Speed

A remote potentiometer may be connected to control the pump speed. Use a potentiometer of between 1K and 10KOhms, with a minimum power of 0.25W. Connect the potentiometer as shown. Set the pump to analogue control. Do not apply another voltage or current control signal while using a remote potentiometer.

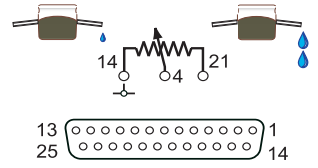

MemoDose

A Watson-Marlow remote control footswitch or handswitch may be used to start the dose. The dose will proceed once the switch is pressed. In an emergency press the **STOP** key to stop the dose. The switch should be connected as shown. Or a TTL compatible logic signal may be applied to pin 8. (Low 0V High 5V maximum. Ground to pin 9).

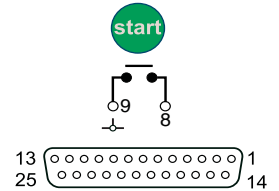

Du

17.2 RS232 serial link

The RS232 interface will give basic pump control by serial link to the 9-way D connector at the rear of the pump.

To select RS232 serial control, repeat **MODE** key press until "dig" is showing in the display. Any analogue signals, or remote control inputs, applied to the 25-way D connector will be ignored.

The 323Du version of the serial interface provides a direct link to a single pump. The pump has no unique address but the software requires a pump identification of 1.

Never apply mains voltage to the 9-way D connector. Only RS232 signals may be applied to pins 2,3,5 and 8. Do not apply voltage across other pins. Permanent damage, not covered by warranty, may result.

Connections for RS232 signals (viewed from inside the pump interface plug)

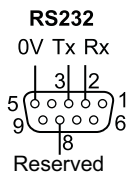

Use only twin shielded RS232 cables for interconnections.

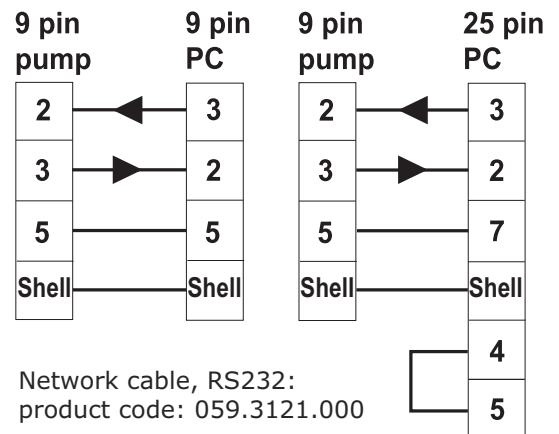

RS232 settings	
Baud	9600
Stop bits	2
Data bits	8
Parity	None
Flow control	None
Echo	On

Pump interface pin	Function
1	-
2	RX (Receive data)
3	TX (Transmit data)
4	-
5	GND (Ground)
6	-
7	-
8	Reserved
9	-

RS232 command modes

These are the codes to control the pump with the RS232 serial link. They must be sent to the pump from a computer serial port (or equivalent).

Com-mand	Function	Com-mand	Function
1SPxxx	Set pump speed to xxx	1RC	Reverse direction
1SI	Increase speed by 1rpm	1RR	Set clockwise direction
1SD	Reduce speed by 1rpm	1RL	Set counter-clockwise direction
1GO	Start pump	1RS	Show all pump information
1ST	Stop pump	1ZY	Show running status of the pump. STARTed 1 or STOPped 0

Always terminate each command with a RETURN (ASCII CHR13).

Notes on control codes

There should be at least 10mS between commands.

The command RS to show all pump information will return the following text string:

[pump type] [speed] [CW / CCW rotation] [stopped/running, 0 /1] [! delimiter]
 e.g. 323Du 110 CW 1 !

Note: both 9 and 25-way D shells are earthed.

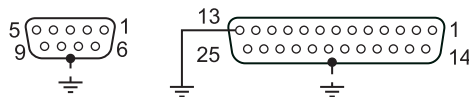

E, S, U, Du

18 Care and maintenance

The pump is sealed to IP31 and is suitable for wipe down cleaning. Do not use solvents, mechanical scourers, strong organic acids, or alkali based cleaning solutions.

Remove any tubing, detach the pumphead, and wash the pumphead thoroughly with a mild solution of detergent in water.

Check moving parts of the rotor from time to time for freedom of movement. Lubricate pivot points and rollers occasionally with Teflon lubricating oil.

The pump has a good, broad chemical resistance to inorganic acids, saline solutions, alkalis, some hydrocarbons and a large number of oils and greases. It is suitable for wipe down but not for long term contact with alcohols. The case may be damaged by contact with strong acids or strong solvents

There are no user serviceable parts inside the pump. The unit should be returned to Watson-Marlow or its appointed agents or distributors for service.

E, S, U, Du

19 Troubleshooting

If the pump display remains blank when the pump is on, make the following checks:

- Check the position of the voltage selector switch at the rear of the pump.
- Check the mains power switch at the rear of the pump.
- Check that mains power is available to the pump.
- Check the fuse in the fuse drawer of the IEC mains power connector at the rear of the pump.
- Check the fuse in the mains power plug if one is present.

If the pump runs but there is little or no flow, make the following checks:

- Check that the tube and rotor are in the pumphead.
- Check that fluid is supplied to the pump.
- Check that the tube is not split or burst.
- Check for any kinks or blockages in the lines.
- Check that any valves in the lines are open.
- Check that the correct wall-thickness tube is being used.
- Check direction of rotation.
- Check that the rotor is not slipping on the drive shaft.

If trouble persists, technical assistance for this product is available from your distributor or Watson-Marlow Ltd, Falmouth TR11 4RU, United Kingdom.

19.1 Error messages

If a fault condition is detected the pump will stop. All keys will be disabled. The display will show the error number:

Error	Error condition	Suggested action
0	RAM write error	Attempt to reset by switching power OFF / ON. Or seek support
1	RAM corruption	Attempt to reset by switching power OFF / ON. Or seek support
2	OTP ROM error / corruption	Attempt to reset by switching power OFF / ON. Or seek support
3	OTP ROM read error	Attempt to reset by switching power OFF / ON. Or seek support
5	Unknown pump type	Check the interface card and cables. Attempt to reset by switching power OFF / ON. Or seek support
7	Display failure	Seek support
8	Wrong key-press	Attempt key-press again. Attempt to reset by switching OFF / ON
9	Motor stalled	Stop pump immediately. Check pumphead and tube. Power OFF/ON may reset. Or seek support
10	Tacho fault	Stop pump immediately. Power OFF/ON may reset. Or seek support
14	Over speed	Stop pump immediately. Power OFF/ON may reset. Or seek support
15	Over current	Stop pump immediately. Check system. Power OFF/ON may reset. Or seek support
16	Over voltage	Stop pump immediately. Check mains voltage selector switch. Check supply. Power OFF/ON may reset. Or seek support
17	Under voltage	Stop pump immediately. Check mains voltage selector switch. Check supply. ON/OFF may reset. Or seek support
18	Watchdog error	Attempt to reset by switching power OFF / ON. Or seek support
19	Over temperature	Stop pump immediately. Turn OFF. Seek support
20	Signal out of range	Check analogue control signal range. Trim signal as required. Or seek support
21	Over signal	Reduce the analogue control signal
22	No signal	Connect analogue control signal or return to manual control
25	Network not detected	Turn OFF. Check network and connections. Or seek support
26	RS232 fault	Turn OFF. Check network and connections. Or seek support
27	RS232 lost	Turn OFF. Check network and connections. Or seek support
33	Unrecognised keypress	Attempt keypress again. Attempt to reset by switching power OFF/ON. Otherwise seek support.
35	Work overload	Turn OFF. Check power supply. Check pumphead and tubing. Wait 30 minutes. Power ON may reset. Otherwise seek support.
ERR	General error condition	Turn OFF. Seek support

E, S, U, Du

20 Drive maintenance

There are no user serviceable parts inside the pump. The unit should be returned to Watson-Marlow or its appointed agents or distributors for service.

E, S, U, Du

21 Drive part numbers

Drives only

Part number	Drive type	Drive speed	Pumphead	Mains lead type
036.3124.00U	323E	400	N/A	UK
036.3132.00U	323S	220	N/A	UK
036.3134.00U	323S	400	N/A	UK
036.3142.00U	323U	220	N/A	UK
036.3144.00U	323U	400	N/A	UK
036.3152.00U	323Du	220	N/A	UK
036.3154.00U	323Du	400	N/A	UK

Complete pump assemblies

Part number	Drive type	Drive speed	Pumphead	Mains lead type
030.3124.3DU	323E	400	313D	UK
030.3132.RLU	323S	220	501RL	UK
030.3134.3DU	323S	400	313DW	UK
030.3142.RLU	323U	220	501RL	UK
030.3144.3DU	323U	400	313DW	UK
030.3152.RLU	323Du	220	501RL	UK
030.3154.3DU	323Du	400	313DW	UK

For US mains lead, replace 'U' with 'A' at end of part number.
For European mains lead, replace 'U' with 'E'.



22 Drive spares

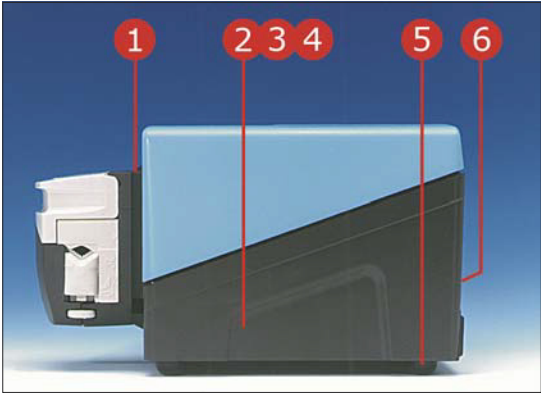

Spare	Description
1 MNA2042A	313 and MC bayonet mounting plate (400 rpm models only)
2 MN2056M	E and S interface card cover
3 MN2094T	U interface card cover
4 MN2095T	Du interface card cover
5 FB0009	Foot
6 FS0003	Fuse

23 Pumpheads

23.1 Pumpheads: key safety information



Before opening the pumphead track please ensure that the following safety directions are followed.

- Ensure that the pump is isolated from mains voltage.
- Ensure that there is no pressure in the pipeline.
- If a tube failure has occurred, ensure that any product in the pumphead has been allowed to drain to a suitable drain.
- Ensure that protective clothing and eye protection are worn if hazardous products are being pumped.

23.2 313D and 314D pumpheads



314D pumpheads should run no faster than 300 rpm when in continuous use. Speeds up to 400 rpm are permissible for intermittent use.

The 313D pumphead has three rollers and is designed to provide higher flow rates. The 314D pumphead has four rollers to provide greater pumping precision with less pulsation in the flow. Both designs are available for 1.6mm and 2.4mm wall tubes.

New tubing can be loaded easily into the flip top design. The top closes with a "clamp and stretch" action to locate the tube in the correct position and with the correct tension.

Standard and extension pumpheads are bayonet mounted. This ensures easy cleaning and fast set up.

Tube selection

The chemical compatibility list published in the Watson-Marlow web site is only a guide. If in doubt request a tube sample card for immersion trials.

Installation

323 400 rpm drives (shown) have an integral mounting plate to attach a 313 or 314 pumphead.



Engage the pumphead drive slot with the end of the pump drive shaft. Continue to align the pumphead until the bayonet engages with the mounting plate. Turn the pumphead clockwise until it locks into an upright position.

Removal



Push the locking lever back and turn the pumphead anti-clockwise until it is free from the mounting plate.

Tube loading

Switch off the pump before tube loading. Lift the "flip top" track until fully open.

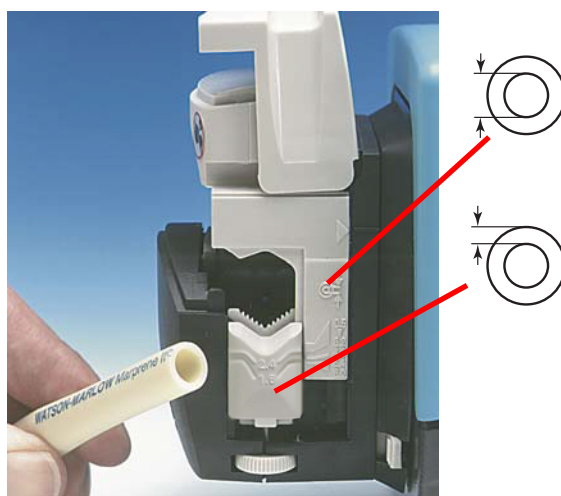

Set the tube clamps to the correct tube size. The track must be fully open. Align the scale on both sides of the pumphead.

If the tube is dirty, or there is a high suction lift, the tube clamps may need a smaller setting to secure the tube.



- Select enough tube length for the curve of the pump track. Slide the tube into the open pumphead. The tube must not be twisted or stretched against the rollers.
- Ensure the tubing locates in the centre of the tube clamps. Carefully lower the track. Check that the tube is not crushed in the clamps or over stretched.

When using Marprene tubing

Re-tension new tube after the first 30 minutes of running. Stop the pump. Release the flip top. Allow the tube to resettle naturally across the rollers. Re-clamp the tube. Restart the pump. This will correct the normal stretching that occurs with new Marprene tube. The correct tension is essential for good tube life.

23.3 313D and 314D pumphead order codes



	Spare	Description
1	033.3411.000	313D three-roller pumphead
2	033.3431.000	313X extension three-roller pumphead
1	033.4411.000	314D four-roller pumphead
2	033.4431.000	314X extension four-roller pumphead
1	033.3511.000	313D2 three-roller pumphead for 2.4mm tube
2	033.3531.000	313X2 extension three-roller pumphead for 2.4mm tube
1	033.4511.000	314D2 four-roller pumphead for 2.4mm tube
2	033.4531.000	314X2 extension four-roller pumphead for 2.4mm tube

23.4 313D and 314D flow rates

Flow rates were obtained using silicone tubing with the pumphead rotating clockwise, pumping water at 20°C with zero suction and delivery pressures. For critical applications determine flow rates under operating conditions.

Flow rates, 313D, 1.6mm wall (ml/min)								
bore	mm	0.5	0.8	1.6	3.2	4.8	6.4	8.0
	in	1/50	1/32	1/16	1/8	3/16	1/14	5/16
#		112	13	14	16	25	17	18
15-400 rpm		0.45-12	1.1-28	4.1-110	15-400	33-880	54-1400	75-2000
3-400 rpm		0.09-12	0.21-28	0.81-110	3.0-400	6.6-880	11-1400	15-2000
1.5-220 rpm		0.05-6.6	0.11-15	0.41-59	1.5-220	3.3-480	5.4-790	7.5-1100

Flow rates, 314D, 1.6mm wall (ml/min)								
bore	mm	0.5	0.8	1.6	3.2	4.8	6.4	8.0
	in	1/50	1/32	1/16	1/8	3/16	1/14	5/16
#		112	13	14	16	25	17	18
15-400 rpm		0.45-12	0.90-24	3.8-100	13-340	29-760	45-1200	60-1600
3-400 rpm		0.09-12	0.18-24	0.75-100	2.6-340	5.7-760	9.0-1200	12-1600
1.5-220 rpm		0.05-6.6	0.09-13	0.38-55	1.3-190	2.9-420	4.5-660	6.0-880

Note: 314D pumpheads should run no faster than 300 rpm when in continuous use. Speeds up to 400 rpm are permissible for intermittent use.

23.5 313D and 314D: maximum number of pumpheads

313D, 314D Pumpsil, 0-0.5 bar								
bore	mm	0.5	0.8	1.6	3.2	4.8	6.4	8.0
	in	1/50	1/32	1/16	1/8	3/16	1/14	5/16
#		112	13	14	16	25	17	18
220/400 rpm		6	6	5	3	2	2	1

313D, 314D Pumpsil, 0.5-2 bar								
bore	mm	0.5	0.8	1.6	3.2	4.8	6.4	8.0
	in	1/50	1/32	1/16	1/8	3/16	1/14	5/16
#		112	13	14	16	25	17	18
220/400 rpm		6	6	5	3	2	1	1

313D, 314D Marprene, Bioprene, Tygon, Neoprene, Fluorel, 0-2 bar								
bore	mm	0.5	0.8	1.6	3.2	4.8	6.4	8.0
	in	1/50	1/32	1/16	1/8	3/16	1/14	5/16
#		112	13	14	16	25	17	18
220/400 rpm		6	6	4	2	2	1	1

313D, 314D STA-PURE, CHEM-SURE, 0.5-2 bar								
bore	mm	1.6	3.2	4.8	6.4	8.0		
	in	1/16	1/8	3/16	1/14	5/16		
#		14	16	25	17	18		
220/400 rpm		1	1	1	1	1		

313D2, 314D2 Pumpsil, Marprene, Bioprene, Tygon, Neoprene, Fluorel, STA-PURE, CHEM-SURE, 0-2 bar								
bore	mm	0.5	0.8	1.6	3.2	4.8	6.4	8.0
	in	1/50	1/32	1/16	1/8	3/16	1/14	5/16
#		112	13	14	16	25	17	18
220/400 rpm		1	1	1	1	1	1	1

Note: 314D pumpheads should run no faster than 300 rpm when in continuous use. Speeds up to 400 rpm are permissible for intermittent use.

23.6 313D and 314D: tubing part numbers

1.6mm tube						
mm	in	#	Marprene	Bioprene	CHEM-SURE	Pumpsil
0.5	1/50	112	902.0005.016	903.0005.016		913.A005.016
0.8	1/32	13	902.0008.016	903.0008.016		913.A008.016
1.6	1/16	14	902.0016.016	903.0016.016	965.0016.016	913.A016.016
3.2	1/8	16	902.0032.016	903.0032.016	965.0032.016	913.A032.016
4.8	3/16	25	902.0048.016	903.0048.016	965.0048.016	913.A048.016
6.4	1/4	17	902.0064.016	903.0064.016	965.0064.016	913.A064.016
8.0	5/16	18	902.0080.016	903.0080.016	965.0080.016	913.A080.016

1.6mm tube						
mm	in	#	PVC	Fluorel	Neoprene	STA-PURE
0.8	1/32	13			920.0008.016	
1.6	1/16	14	950.0016.016	970.0016.016	920.0016.016	960.A016.016
3.2	1/8	16	950.0032.016	970.0032.016	920.0032.016	960.A032.016
4.8	3/16	25	950.0048.016	970.0048.016	920.0048.016	960.A048.016
6.4	1/4	17	950.0064.016	970.0064.016	920.0064.016	960.A064.016
8.0	5/16	18	950.0080.016	970.0080.016	920.0080.016	960.A080.016

2.4mm tube						
mm	in	#	Marprene	Bioprene	Pumpsil	
0.5	1/50	105			913.0005.024	
0.8	1/32	108			913.0008.024	
1.6	1/16	119	902.0016.024	903.0016.024	913.0016.024	
3.2	1/8	120	902.0032.024	903.0032.024	913.0032.024	
4.8	3/16	15	902.0048.024	903.0048.024	913.0048.024	
6.4	1/4	24	902.0064.024	903.0064.024	913.0064.024	

23.7 314MC and 318MC microcassette pumpheads



314MC and 318MC pumpheads must not run at speeds greater than 110 rpm.

Each pumphead offers five pumping channels, and the manifold tubing is preloaded in removable cassettes. The 314MC pumphead has four rollers and is designed to provide higher flow rates. The 318MC pumphead has eight rollers for higher pumping precision with less pulsation.

Each cassette will accept any one of nineteen tube sizes available. Adjacent cassettes may contain different types or size of tubing.

New tube loads easily in the cassette design. Cassettes locate quickly with a single cam lever action that also controls roller pressure against the tube.

Extension pumpheads may be added up to 10 channels. All are bayonet mounted for easy cleaning and fast set up.

Tube selection

The chemical compatibility list published in the Watson-Marlow web site is only a guide. If in doubt request a tube sample card for immersion trials.

Installation

323 400 rpm drives (shown) have an integral mounting plate to attach a 314MC or 318MC pumphead.



Engage the pumphead drive slot with the end of the pump drive shaft. Continue to align the pumphead until the bayonet engages with the mounting plate. Turn the pumphead clockwise until it locks into an upright position.

Removal



Push the locking lever back and turn the pumphead anti-clockwise until it is free from the mounting plate.

Tube loading

Tube size is identified by the colour of the three collars.

These collars divide the manifold tube element into two alternative pumping segments. Either segment may be fitted in the pump cassette and this doubles the working life obtained from each manifold tube element.

Tube elements should be inspected regularly, and moved to their second segment, prior to failure. Ensure the tubing has not bonded to the cassette track. Check the whole tube surface within the cassette.



- Move the cam lever over to unlock the cassette. Lift the cassette from the track and remove any tubing.
- Slot one end of the new tubing segment into a cassette leg. Slot the other end of the tubing segment into the other cassette leg. The collars must be outside the cassette legs. Slide the tubing evenly down into the slots. Do not twist the tube or use unnecessary force.
- Slip the collars past the retaining fingers and ensure the tubing has reached the bottom of the slots. Carefully pull the tube in towards the cassette to fix the collars in position.



- Drop the loaded cassette into the pumphead. Cassettes will fit in the pumphead in either direction and we recommend they are all fitted in the same direction.
- Push the cassette down until the cassette legs will hook into the pumphead body. Ensure the tube has settled naturally into the cassette track and is not pinched by the edge of the cassette.



- Flip the cam lever upright to lock the cassette in the pumphead.
- The cam lever controls the occlusion of the tube against the rollers. To pump against higher pressure the cam lever may be moved beyond the vertical position. Tube life will be shortened and drive torque will be increased. This will reduce the number of cassettes that may be fitted to the pump.

23.8 314MC and 318MC microcassette pumphead spares



	Spare	Description
1	033.6453.000	314MC four roller five channel pumphead
1	033.6454.000	314MCX four roller five channel extension pumphead
1	033.6853.000	318MC eight roller five channel pumphead
1	033.6854.000	318MCX eight roller five channel extension pumphead
2	MNA0286A	Micro cassette

23.9 314MC and 318MC flow rates

Flow rates were obtained using silicone tubing with the pumphead rotating clockwise, pumping water at 20°C with zero suction and delivery pressures. For critical applications determine flow rates under operating conditions. The important factors are suction and delivery pressure, temperature, and fluid viscosity. Tube life will be reduced when pumping against pressure.

Flow rates, 314MC (ml/min)				
Tube code	Bore	3 rpm	15 rpm	110 rpm
orange/black	0.13mm /0.005in	0.002	0.01	0.09
orange/red	0.19mm /0.007in	0.008	0.04	0.30
orange/blue	0.25mm /0.010in	0.01	0.07	0.50
orange/green	0.38mm /0.015in	0.03	0.13	0.90
orange/yellow	0.50mm /0.020in	0.05	0.23	1.7
orange/white	0.63mm /0.025in	0.08	0.42	3.1
black/black	0.76mm /0.030in	0.13	0.63	4.6
orange/orange	0.88mm /0.035in	0.17	0.87	6.4
white/white	1.02mm /0.040in	0.22	1.1	8.1
red/red	1.14mm /0.045in	0.27	1.4	9.9
grey/grey	1.29mm /0.050in	0.35	1.8	13
yellow/yellow	1.42mm /0.055in	0.46	2.3	17
yellow/blue	1.52mm /0.060in	0.52	2.6	19
blue/blue	1.65mm /0.065in	0.60	3.0	22
green/green	1.85mm /0.070in	0.76	3.8	28
purple/purple	2.05mm /0.080in	0.90	4.5	33
purple/black	2.29mm /0.090in	1.1	5.5	40
purple/orange	2.54mm /0.100in	1.3	6.4	47
purple/white	2.79mm /0.110in	1.4	7.2	53

Flow rates, 318MC (ml/min)				
Tube code	Bore	3 rpm	15 rpm	110 rpm
orange/black	0.13mm /0.005in	0.002	0.01	0.09
orange/red	0.19mm /0.007in	0.008	0.04	0.30
orange/blue	0.25mm /0.010in	0.01	0.06	0.50
orange/green	0.38mm /0.015in	0.02	0.11	0.80
orange/yellow	0.50mm /0.020in	0.04	0.19	1.4
orange/white	0.63mm /0.025in	0.07	0.35	2.6
black/black	0.76mm /0.030in	0.11	0.53	3.9
orange/orange	0.88mm /0.035in	0.14	0.72	5.3
white/white	1.02mm /0.040in	0.18	0.90	6.6
red/red	1.14mm /0.045in	0.24	1.2	8.8
grey/grey	1.29mm /0.050in	0.27	1.4	10
yellow/yellow	1.42mm /0.055in	0.33	1.6	12
yellow/blue	1.52mm /0.060in	0.38	1.9	14
blue/blue	1.65mm /0.065in	0.46	2.3	17
green/green	1.85mm /0.070in	0.55	2.7	20
purple/purple	2.05mm /0.080in	0.65	3.3	24
purple/black	2.29mm /0.090in	0.79	4.0	29
purple/orange	2.54mm /0.100in	0.90	4.5	33
purple/white	2.79mm /0.110in	0.98	4.9	36

23.10 314MC and 318MC tubing part numbers

Tube code	Bore	Marprene*	PVC	Pumpsil
orange/black	0.13mm /0.005in		981.0013.000	
orange/red	0.19mm /0.007in		981.0019.000	
orange/blue	0.25mm /0.010in	979.0025.000	981.0025.000	
orange/green	0.38mm /0.015in	979.0038.000	981.0038.000	
orange/yellow	0.50mm /0.020in	979.0050.000	981.0050.000	
orange/white	0.63mm /0.025in	979.0063.000	981.0063.000	983.0063.000
black/black	0.76mm /0.030in	979.0076.000	981.0076.000	983.0076.000
orange/orange	0.88mm /0.035in	979.0088.000	981.0088.000	983.0088.000
white/white	1.02mm /0.040in	979.0102.000	981.0102.000	983.0102.000
red/red	1.14mm /0.045in	979.0114.000	981.0114.000	983.0114.000
grey/grey	1.29mm /0.050in	979.0129.000	981.0129.000	983.0129.000
yellow/yellow	1.42mm /0.055in	979.0142.000	981.0142.000	983.0142.000
yellow/blue	1.52mm /0.060in	979.0152.000	981.0152.000	983.0152.000
blue/blue	1.65mm /0.065in	979.0165.000	981.0165.000	983.0165.000
green/green	1.85mm /0.070in	979.0185.000	981.0185.000	983.0185.000
purple/purple	2.05mm /0.080in	979.0205.000	981.0205.000	983.0205.000
purple/black	2.29mm /0.090in	979.0229.000	981.0229.000	983.0229.000
purple/orange	2.54mm /0.100in	979.0254.000	981.0254.000	983.0254.000
purple/white	2.79mm /0.110in	979.0279.000	981.0279.000	983.0279.000

* Autoclavable tubing: Marprene tubes fitted with suitable collars are available for autoclaving applications. Please replace the the last "0" of the product code with "+". For example: 979.0238.00+. Pumpsil tubing is suitable for autoclaving but standard Marprene tube collars are not suitable because they separate from the tube at high temperatures.

23.11 501RL pumphead

The 501RL and 501RL2 pumpheads are suitable for tubing with internal diameters up to 8.0mm. The 501RL is set during manufacture for use with 1.6mm wall tubing and 501RL2 is set for 2.4mm wall tubing.

The spring-loaded rollers give extended tube life. The pumphead can be run clockwise, for best tube life, or anticlockwise for higher pressures. The "tool lockable" guard should be locked shut while the pump is in use.

23.12 501RL and 501RL2 installation

The 501RL track will fit on the drive in three orientations. Secure the track with the locating screw.

The rotor grips the drive shaft via a split collet. Ensure the drive shaft is degreased before fitting the rotor. This will prevent the rotor slipping on the drive shaft during operation. Tighten the rotor screw to a torque of 3Nm.

The track and rotor may be removed from the pump for cleaning or to reposition the track on the pump.

There is a drive pin inside the rotor collet to engage with the end of the drive shaft. To keep this pin correctly engaged on the drive shaft, we recommend that the collet remains on the shaft, while the rotor is removed. Hold the rotor firmly and remove the rotor retaining screw. Pull the rotor from the drive shaft leaving the collet on the drive shaft. Remove the track locating screw. You may remove the track or rotate to the new position. Align the track and refit the track locating screw. Refit the rotor.

23.13 501RL and 501RL2 tube loading

Switch off the mains supply. Unlock and open the pumphead guard.

Select a minimum length of 240mm of tubing. Fit one end of the tubing into a clamp.

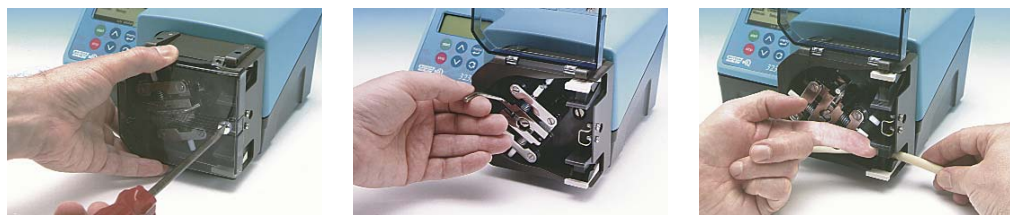

The rotor has tube guide rollers that pull the tube into the pumphead during loading. Turn the rotor carefully until the tube guides pick up the tube. Continue to turn the rotor, and feed the tubing in between the guides.

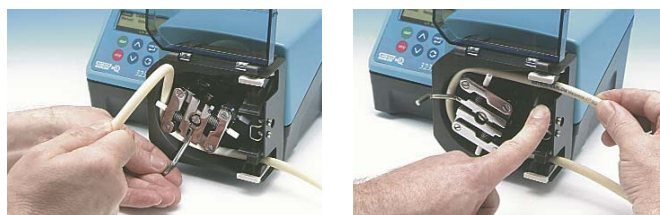

When the tube has gone round the pump track fit the other end of the tubing into the clamp. Check that the tubing has fitted naturally against the track for best tube life. Release the clamps and adjust the tubing if it is slack, twisted, or stretched.



The tube clamps can accommodate various tube diameters by pushing in, or pulling out, the grip bars within the clamp. Set the clamps to apply the minimum necessary pressure to the tubing.

Restart the pump. Free the downstream clamp for a short time, while the pump is running, so that the tube can find its natural length. Please keep fingers clear of the moving rotor. Shut and lock the guard after adjusting the tube.

When using Marprene tubing

Re-tension new tube after the first 30 minutes of running. Stop the pump and release the tube clamp at the outlet of the pump. Pull any slack tube from the pumphead and re-clamp the tube. Re-start the pump. This will correct the normal stretching that occurs with new Marprene tube. The correct tension is essential for good tube life.

23.14 501RL and 501RL2 rotor settings

The 501RL and 501RL2 pumpheads are factory set to give optimum tube life with Watson-Marlow tubing. We recommend that the rotors are not adjusted or that other types of tubing are not used.

If the rotor needs re-aligning we recommend the rotor is returned to Watson-Marlow for correct adjustment. Or contact our technical department for further information.

Check moving parts of the rotor from time to time for freedom of movement. Lubricate pivot points and rollers occasionally with Teflon lubricating oil.

23.15 501RL and 501RL2 pumphead spares

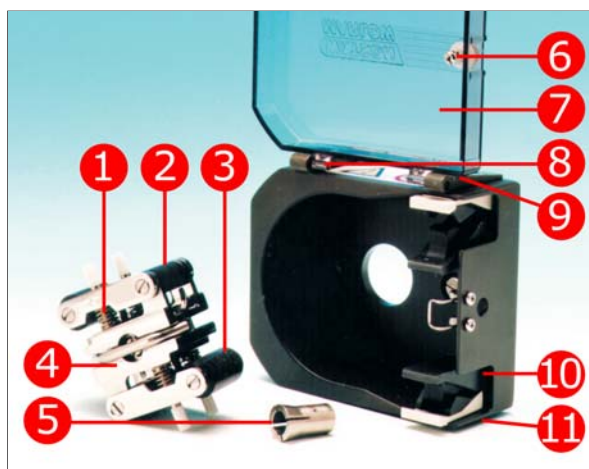

	Spare	Description
	053.0001.L00	501RL complete pumphead
	053.0001.L20	501RL2 complete pumphead
1	SG001 SG002	Springs for 501RL (blue) Springs for 501RL2 (red)
2	MN0012T	Follower roller
3	MN0011T	Main roller
4	MNA0143A	501RL rotor assembly
5	CL0656T	Collet
6	FN4502	Lock
7	MN1200M	Lockable guard
8	MN0266M	Hinge
9	FN2341	Hinge screw
10	MNA0114A	Tube clamp assembly
11	FN2332	Screw
-	XX0095	Teflon lubricant

23.16 501RL and 501RL2 flow rates

Flow rates were obtained using silicone tubing with the pumphead rotating clockwise, pumping water at 20°C with zero suction and delivery pressures. For critical applications determine flow rates under operating conditions. The important factors are suction and delivery pressure, temperature and fluid viscosity. Tube life will be reduced when pumping against pressure.

Flow rates, 501RL, 1.6mm wall, 501RL2, 2.4mm wall (ml/min)								
bore	mm	0.5	0.8	1.6	3.2	4.8	6.4	8.0
	in	1/50	1/32	1/16	1/8	3/16	1/14	5/16
#		112	13	14	16	25	17	18
1.5-220 rpm	0.06-9.2	0.18-27	0.64-94	2.8-410	6.1-890	9.5-1400	15-2200	

23.17 501RL and 501RL2: tubing part numbers

1.6mm tube for 501RL pumpheads						
mm	in	#	Marprene	Bioprene	CHEM-SURE	Pumpsil
0.5	1/50	112	902.0005.016	903.0005.016		913.A005.016
0.8	1/32	13	902.0008.016	903.0008.016		913.A008.016
1.6	1/16	14	902.0016.016	903.0016.016	965.0016.016	913.A016.016
3.2	1/8	16	902.0032.016	903.0032.016	965.0032.016	913.A032.016
4.8	3/16	25	902.0048.016	903.0048.016	965.0048.016	913.A048.016
6.4	1/4	17	902.0064.016	903.0064.016	965.0064.016	913.A064.016
8.0	5/16	18	902.0080.016	903.0080.016	965.0080.016	913.A080.016

1.6mm tube for 501RL pumpheads						
mm	in	#	PVC	Fluorel	Neoprene	STA-PURE
0.8	1/32	13			920.0008.016	
1.6	1/16	14	950.0016.016	970.0016.016	920.0016.016	960.0016.016
3.2	1/8	16	950.0032.016	970.0032.016	920.0032.016	960.0032.016
4.8	3/16	25	950.0048.016	970.0048.016	920.0048.016	960.0048.016
6.4	1/4	17	950.0064.016	970.0064.016	920.0064.016	960.0064.016
8.0	5/16	18	950.0080.016	970.0080.016	920.0080.016	960.0080.016

Note: CHEM-SURE and STA-PURE are supplied in 305mm lengths.

2.4mm tube for 501RL2 pumpheads					
mm	in	#	Marprene	Bioprene	Pumpsil
0.5	1/50	105			913.A005.024
0.8	1/32	108			913.A008.024
1.6	1/16	119	902.0016.024	903.0016.024	913.A016.024
3.2	1/8	120	902.0032.024	903.0032.024	913.A032.024
4.8	3/16	15	902.0048.024	903.0048.024	913.A048.024
6.4	1/4	24	902.0064.024	903.0064.024	913.A064.024
8.0	5/16	121	902.0080.024	903.0080.024	913.A080.024

E, S, U, Du

24 Trademarks

Watson-Marlow, Bioprene, Pumpsil and Marprene are trademarks of Watson-Marlow Limited.

Fluorel is a trademark of 3M.

Sta-Pure and Chem-Sure are trademarks of W.L.Gore and Associates.

E, S, U, Du

25 Warning not to use pumps in patient-connected applications

Warning: These products are not designed for use in, and should not be used for patient-connected applications.

E, S, U, Du

26 Publication history

m-323e-s-u-du-gb-07.qxp: Watson-Marlow 323E, 323S, 323U and 323Du.

First published 01 02. Revised 01 08. Revised 09 17. Revised 03 24.

27 Decontamination certificate

In compliance with the UK Health and Safety at Work Act and the Control of Substances Hazardous to Health Regulations, you are required to declare the substances which have been in contact with product(s) you return to Watson-Marlow or its subsidiaries or distributors. Failure to do so will cause delays. Please ensure that you fax us this form and receive an RGA (Returned Goods Authorisation) before you despatch the product(s). A copy of this form must be attached to the outside of the packaging containing the product(s). Please complete a separate decontamination certificate for each product. You are responsible for cleaning and decontaminating the product(s) before return.

Your name	<input type="text"/>	Company	<input type="text"/>
Address	<input type="text"/>		
Postcode/zip	<input type="text"/>	Country	<input type="text"/>
Telephone	<input type="text"/>	Fax	<input type="text"/>
Product type	<input type="text"/>	Serial number	<input type="text"/>
To speed the repair, please describe all known faults	<input type="text"/>		
The product has ...	<input type="checkbox"/> Been used <input type="checkbox"/> Not been used		
	<i>If the product has been used, please complete all the following sections. If the product has not been used, please just sign this form.</i>		
Names of chemicals handled with product(s)	<input type="text"/>		
Precautions to be taken in handling these chemicals	<input type="text"/>		
Action to be taken in the event of human contact	<input type="text"/>		
	<i>I understand that the personal data collected will be kept confidentially in accordance with the UK Data Protection Act 1998.</i>		
Signature	<input type="text"/>	RGA number	<input type="text"/>
		Your position	<input type="text"/>
		Date	<input type="text"/>
<i>Please print out, sign and fax to Watson-Marlow Pumps at +44 1326 376009.</i>			