

Weirless Radial diaphragm™ in-line valve

Installation, operating, and maintenance manual

Contents

1 Safety notes	2
2 Overview	5
2.1 Valve description	5
3 When you unpack your valve	6
3.1 Unpacking your valve assembly	6
3.2 Packaging disposal	6
3.3 Inspection	6
3.4 Components supplied	6
3.5 Storage	6
4 Start-up check list	7
5 Diaphragm selection	8
6 Installation	9
6.1 Install the valve body	9
6.2 Install and remove diaphragm - manual actuator	9
6.3 Install and remove diaphragm - pneumatic actuator	14
7 Actuators — AKS series	18
7.1 Maintaining an AKS manual actuator	18
7.2 Maintaining an AKS pneumatic actuator	21
8 Cleaning and sterilisation	28
9 Specifications	29
10 Troubleshooting	30
10.1 Technical support	31
11 Parts list	32
11.1 Replacement diaphragms	32
11.2 Actuator maintenance kits	32
12 Warranty	33
13 Information for returning products	34
14 Name and address of manufacturer	35
15 Trademarks	35
16 Publication history	35
17 Disclaimers	35

1 Safety notes

This safety information should be used in conjunction with the rest of this operating manual.

In the interests of safety, this valve and actuator should only be used by competent, suitably trained personnel after they have read and understood the manual and considered any hazard involved. If the valve is used in a manner not specified by ASEPCO, the protection provided by the valve and actuator may be impaired. Any person who is involved in the installation or maintenance of this equipment should be fully competent to carry out the work. In the UK this person should also be familiar with the Health and Safety at Work Act 1974 or its equivalent in other regions.



This symbol, used on the product and in the manual, means: Possibility of severe personal injury, loss of life, or equipment damage in indicated situation. Ensure all instructions are followed.



This symbol, used on the product and/or in the manual, means: Caution, high pressure air and/or high process pressure hazard.



This symbol, used on the product and in the manual, means: Caution, hot surface.



This symbol, used on the product and in the manual, means: Caution, risk of electric shock.



This symbol, used on the product and in the manual, means: Personal Protective Equipment (PPE) must be worn at all times.



Do not use ASEPCO products outside of their specified operating range.



If valve is installed in a line carrying hazardous fluids then safety procedures specific to the particular fluid and application must be put in place to protect against injury to persons.



To avoid moisture build up and increased actuator wear, use only clean dry air to operate pneumatic actuators.

Avoid personal injury and property damage from any sudden release of process pressure. Before performing any maintenance operations:



- **Disconnect any operating lines providing air pressure, electric power, or a control signal to the actuator. Be sure the actuator cannot suddenly open or close the valve.**
- **Do not remove the actuator from the valve while the valve is still pressurised.**
- **Use bypass valves or completely shut off the process to isolate the valve from process pressure. Relieve process pressure on both sides of the valve. Drain the process media from both sides of the valve.**
- **Check with your process safety engineer for any additional measures that must be taken to protect against process media.**



Ensure that chemicals that come in direct contact with valve assembly and its components are compatible with the valve body, actuator, diaphragm, to be used in the fluid path. If you need assistance please contact your local sales office.



Exterior surfaces of the valve may become hot during operation. The unit should be allowed to cool prior to conducting any repositioning or maintenance operations.



Do not open the valve clamp during steaming or while the valve is under pressure.



Important: Pneumatic actuators should have their seals replaced every 3 years for standard actuators and every year for ATEX actuators. Manual actuators should have their seals replaced every 10 years. See "Parts list" on page 32, for replacement kit part numbers.



The valve and actuator surfaces will be hot following sterilisation in an autoclave and may cause injury when handled. Suitable personal protective equipment must be worn and care must be taken when handling the valve and actuator.



ASEPCO products should be used only in services and within pressure and temperature ranges designated in its product information or specifications or as specifically approved by ASEPCO in writing.

Misuse of ASEPCO products may result in personal injury or property damage. If any ASEPCO valve shows signs of leakage, do not operate—remove it from the line, and repair or replace it.

2 Overview

This manual is the primary information source for the installation, operation and maintenance of ASEPCO Weirless Radial diaphragm in-line valves. The manual also covers the use of manual and pneumatic actuators. Unless labelled otherwise, all instructions are applicable to all valves.

2.1 Valve description

All valves assemble using a hygienic clamp to form a seal, surpassing anything available from weir-style valves. No tools are needed for maintenance.

There are three components to all the valves:

- **Valve body:** Our valve bodies are a single piece machined out of stainless steel bar stock with fittings welded on per customer requirements
- **Actuator:** Manual and pneumatic actuators are available . A number of options are available for the actuators, but for any particular valve the options available depend on the type and size of the valve. See "Specifications" on page 29
- **Diaphragm:** Our weirless radial diaphragms have two primary sealing surfaces: a shutoff seal at the inlet (seat) and a seal at the shoulder between the inside and outside of the valve. For the Weirless valves, two different diaphragm materials are available. See "Parts list" on page 32 for a list of available diaphragm materials.

3 When you unpack your valve

3.1 Unpacking your valve assembly

Unpack all parts carefully, retaining the packaging until you are sure all components are present and in good order. Check against the components supplied list below.

3.2 Packaging disposal

Dispose of packaging materials safely and in accordance with regulations in your area. The outer carton is made of cardboard and can be recycled.

3.3 Inspection

Check that all components are present. Inspect components for damage in transit. If anything is missing or damaged, contact your local sales office immediately.

3.4 Components supplied

- Valve
- Actuator
- Diaphragm
- Clamp
- User Manual

3.5 Storage

This product has an extended shelf life. However, care should be taken after storage to ensure that all parts function correctly.

Diaphragm shelf life

Shelf life for diaphragms is 5 years.

Please observe the storage recommendations and use-by dates which apply to diaphragms that you may wish to bring into service after storage when used with this product.

4 Start-up check list

- Ensure that a suitable diaphragm for your process has been installed into the valve assembly, please refer to the advice in "Diaphragm selection" on the next page for additional information.
- Ensure that all pipes, valves and other equipment in your fluid path are properly supported and secured.
- Ensure that secure connections are achieved between the valve and any piping.
- Manual actuators - Ensure that easy and safe access is provided to the actuator handle, to enable rapid shut off in case of emergency.
- Pneumatic actuators - Ensure proper and safe connection has been made to a suitable air supply.

5 Diaphragm selection

Diaphragm materials must be selected with consideration to heat-resistance, chemical-resistance, steam-resistance, durability and handling as well as the number, temperature and duration of CIP/SIP cycles. It is critical that you select the appropriate diaphragm materials for your process. For material specifications and further information or assistance with material selection, visit www.wmftg.com or contact your local sales office.



Ensure the chemicals to be used with valve assembly are compatible with the valve body, actuator, diaphragm, to be used in the fluid path. If you need assistance please contact your local sales office.

Examine the diaphragm at least once a week for signs of wear. If you have any concerns with the condition of the diaphragm, contact your local sales office.

Diaphragm replacement

It is best practice to replace a diaphragm:

- At least **annually** - For fewer than five SIP cycles a week that are less than two hours each at less than 135C
- At least **every six months** - For five or more SIP cycles a week that are less than two hours each at less than 135C.

The following table summarises the availability of each diaphragm material for the different valve sizes.

Material	Valve Size Availability			
	0.5"	0.75"	1"	1.5"
Silicone	◆	◆	◆	◆
EPDM	◆	◆	◆	◆
EPDM Plus	◆	◆	◆	◆

6 Installation

There are three basic steps to follow to install an ASEPCO valve:

Step 1: Install the valve body.

Step 2: Attach the diaphragm to the actuator assembly

Step 3: Insert the actuator/diaphragm assembly into the valve body and clamp them together.

Please use the following detailed instructions for each of these steps to ensure proper functioning of the valve.

6.1 Install the valve body

There are two basic options for installing a valve body, either you can use a hygienic clamp to clamp it into place, or you can weld it into place.

Clamping the valve body in place

You can use a single-hinge clamp, a double bolt clamp or a double hinge clamp for this purpose. Ask your engineering team about the most appropriate clamp to use.

ASEPCO valves are compatible with a wide range of clamps from a variety of manufacturers.

ASEPCO supplies every valve with a clamp to assemble the actuator/diaphragm assembly to the valve body.

6.2 Install and remove diaphragm - manual actuator

Install the diaphragm

1. Turn the actuator to its fully closed position. The actuator is in the fully closed position when the compressor on the opposite end from the handle is fully exposed.

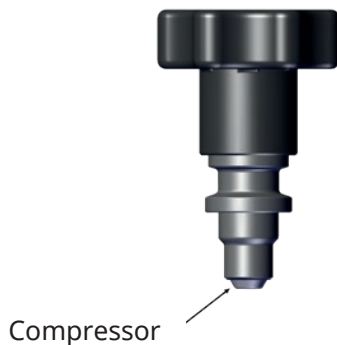

2. Mate the diaphragm (black piece) to the end of the actuator (at compressor end).
Screw the diaphragm onto the actuator until it is finger tight.

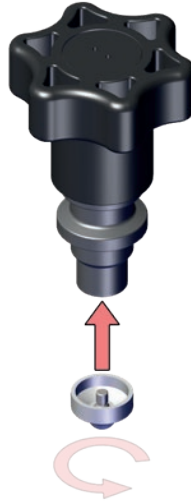

3. Insert the diaphragm/actuator assembly into the valve body.



4. Rotate the actuator handle counter-clockwise two turns to allow the actuator assembly to sit completely in the valve body.

5. Fasten the clamp and finger-tighten.



Remove the diaphragm



Do not open the valve clamp during steaming or while the valve is under pressure.

1. Open the valve by turning handle counter clockwise.
2. Remove the clamp from assembly.



3. Turn the handle clockwise until it stops, this extends the diaphragm into the fully closed position.
4. Remove actuator and diaphragm assembly from the valve body by grasping the actuator and pulling away from the valve body.



5. Turn the diaphragm counter-clockwise to unscrew and remove from the actuator.

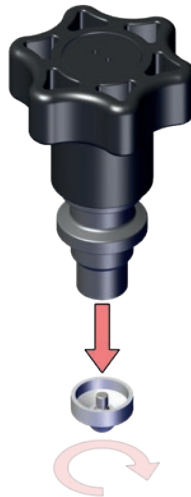

6.3 Install and remove diaphragm - pneumatic actuator

Install the diaphragm

1. Shut off air so actuator is fully closed.
2. Turn diaphragm clockwise to thread the diaphragm onto actuator assembly shaft until finger tight.



3. Insert actuator/diaphragm assembly into valve body.

4. Attach and turn on air source to fully retract diaphragm.



5. Install and tighten clamp while the diaphragm is retracted.
6. Shut off air source to fully close valve.

Remove the diaphragm



Do not open the valve clamp during steaming or while the valve is under pressure.

1. Depressurise the system.
2. Open the valve (by turning the air **on**).
3. Remove the clamp.



4. Close the valve (by turning the air **off** if the valve is normally closed or **on** if normally open).

5. Remove the actuator and diaphragm assembly by grasping the diaphragm edge and pulling it away from the valve body.



6. Disconnect the actuator from the air source.
7. Turn the diaphragm counter-clockwise to unscrew it and remove it from actuator.

7 Actuators – AKS series

7.1 Maintaining an AKS manual actuator

Step 1: Remove the actuator and diaphragm assembly from the valve

Step 2: Remove the diaphragm

Follow the instructions for "Remove the diaphragm" on page 11.

Step 3: Disassemble the actuator and replace O-rings and washers

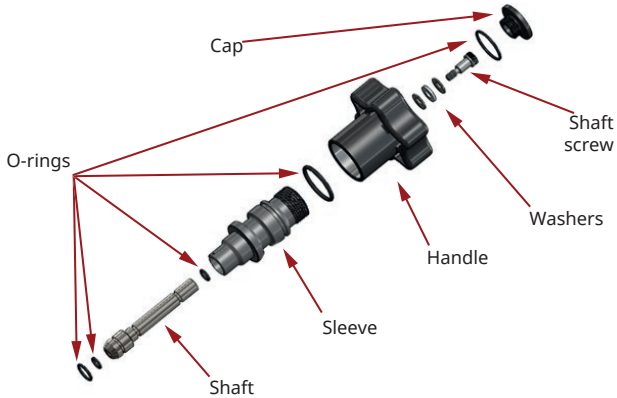

1. Remove the cap with a No. 14 drilled spanner screwdriver.



2. Using a 1/8" hex key, remove the shaft screw.
3. Unthread the handle from the sleeve.
4. Remove the shaft from the sleeve.
5. Remove the O-rings from the shaft, handle and sleeve.

Step 4: Reassemble the actuator

1. Lubricate and install the O-rings on the shaft and sleeve.



2. Insert the shaft into the sleeve.

Note: Make sure the flat on the shaft is aligned with the flat on the sleeve.

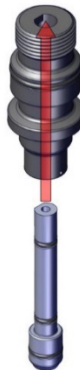

3. Screw the handle onto the sleeve.

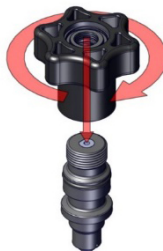

4. Install the O-ring into the groove on the handle.



5. Install the washers and screw onto the handle. Press the compressor towards the handle to ensure the shaft flats remain aligned.

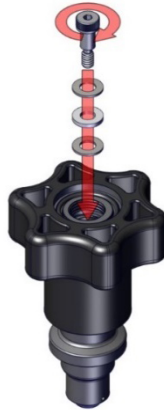

6. Install the cap over the screw using a No. 14 drilled spanner screwdriver.

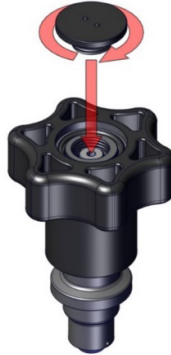

Step 5: Replace the diaphragm

Follow the instructions for "Install the diaphragm" on page 9.

7.2 Maintaining an AKS pneumatic actuator

Step 1: Remove the actuator and diaphragm assembly from the valve

Step 2: Remove the diaphragm

Follow the instructions for "Remove the diaphragm" on page 15.

Step 3: Disassemble and reassemble the pneumatic actuator

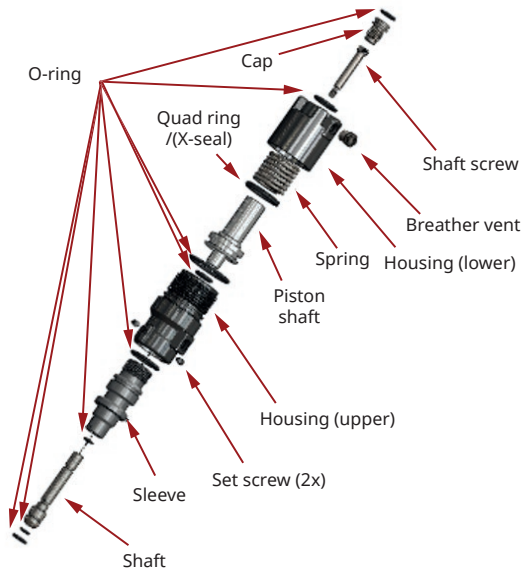

1. Unscrew the cap from the top of the actuator using a 5/16" hex key.
2. Grasp the upper housing while unscrewing the lower housing.
3. Remove the spring from inside of the actuator body.
4. Remove the shaft screw using a 1/8" hex key.
5. Remove the piston.
6. Remove the 10/32 set screws using a 3/32" hex key.
7. Unscrew the housing (upper).
8. Remove the shaft from the sleeve.
9. Remove the O-rings from the shaft, sleeve, piston, housings and cap.

Step 4: Disassemble and reassemble the pneumatic actuator

1. Install the O-rings on the shaft and sleeve.

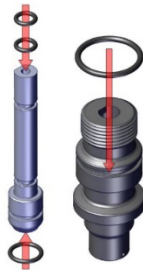

2. Thread the upper housing onto the sleeve.

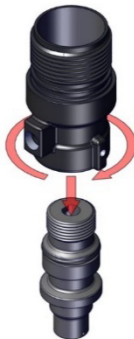

3. Thread the set screws into the upper housing and tighten.



4. Install the inner O-ring into the assembly.



5. Insert the shaft into the sleeve.

Note: Make sure the flat on the shaft is aligned with the flat on the sleeve.



6. Install the O-ring on the outside of the upper housing.



7. Install the quad ring/x-ring on the piston.



8. Insert the piston into the assembly.



9. Insert the spring into the assembly.



10. Insert the O-ring into the lower housing.

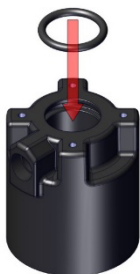

11. Thread the lower housing onto the assembly.



12. Thread the breather vent into the lower housing.

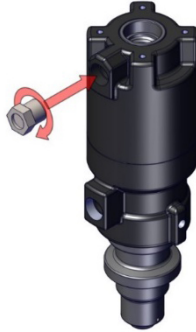

13. Thread the shoulder screw into the assembly. Press the compressor towards the pneumatic cylinder to ensure the shaft flats remain aligned.



14. Install the O-ring on the shaft cap.

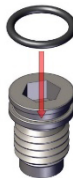

15. Thread the shaft cap into the assembly.



Step 5: Replace the diaphragm

Follow the instructions for "Install the diaphragm" on page 14.

8 Cleaning and sterilisation



Important: Pneumatic actuators should have their seals replaced every 3 years for standard actuators and every year for ATEX actuators. Manual actuators should have their seals replaced every 10 years. See "Parts list" on page 32, for replacement kit part numbers.

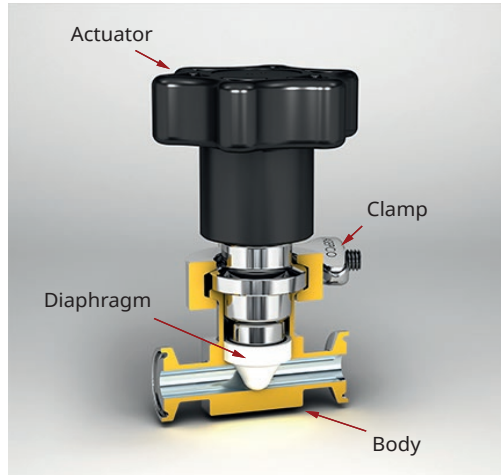

Ensure that your CIP/SIP cleaning process does not compromise the diaphragm due to chemical incompatibility or excessive exposure to high temperatures.

All of our valve bodies and actuators can be sterilised in an autoclave. The diaphragm materials that ASEPCO uses are rated for temperatures of 135C (275F) or higher, depending on the material. So, as long as the autoclaving process is below that temperature it is not necessary to wait for it to cool before reassembly.



The valve and actuator surfaces will be hot following sterilisation in an autoclave and may cause injury when handled. Suitable personal protective equipment must be worn and care must be taken when handling the valve and actuator.

All the actuators have built-in, non-adjustable travel stops that prevent over-tightening of the diaphragm in any conditions, hot or cold.

9 Specifications

Parameter	Value
Maximum operating temperature	135C (275F)
Maximum operating pressure	10bar (150psi)

Model Number	Size	Air pressure minimum
FP05-01	0.5" pneumatic	4bar (60psi)
IP08-01	0.75" pneumatic	4bar (60psi)
IP10-01	1.0" pneumatic	6bar (80psi)
IP17-01	1.5" pneumatic	6bar (80psi)

10 Troubleshooting

Issue	Possible Causes
Leaking process fluid	<ul style="list-style-type: none">• Clamp incorrectly installed onto valve• Actuator seal failure• Diaphragm failure• Diaphragm not screwed on fully• Valve damage
Leaking air	<ul style="list-style-type: none">• Actuator seal failure
Can't open/close valve fully	<ul style="list-style-type: none">• Actuator failure• Diaphragm failure• Diaphragm not screwed on fully
Valve sticking or stuck	<ul style="list-style-type: none">• Sticky diaphragm• Actuator problem

Valve body issues

The most common valve body issues are:

- Valve damage - If you are having issues with leaking around the valve, inspect the valve carefully for damage.
- Leaking diaphragm - If the clamp is not installed correctly, the diaphragm can leak because of poor seating. Follow the assembly instructions carefully.

Actuator issues

The most common actuator issues are:

- Seal failure or leaking seal in a pneumatic actuator - The operator usually hears air leaking from the valve during operation. In addition, the valve may not fully open or close.
- Bends or damages the actuator shaft or handle caused by dropping the valve assembly or actuator - When this occurs, the bent shaft or damaged handle may keep the diaphragm from seating properly, resulting in process fluid leakage.
- Bent or improperly assembled actuator - If the valve does not assemble easily, examine it carefully for damage. Do not force the valve together.
- The valve is not opening or closing easily - Double check the actuator to make sure that it is assembled properly.

Diaphragm issues

Diaphragms are the high-wear components of valves and the most common point of failure. Common causes of diaphragm failure are:

- Incorrect assembly - A diaphragm can wear prematurely if it isn't installed properly on the actuator and in the valve body.
- Actuator failure - Lack of servicing a pneumatic actuator can lead to a catastrophic diaphragm failure. Actuators don't need to be serviced often, but every year or so,

the actuator seals need to be replaced. The frequency depends upon the number of actuations performed.

- Diaphragm overuse—infrequent replacement - Diaphragm lifetime depends upon your process and the chemicals that it comes into contact with.

Replacement at correct intervals will significantly increase the lifetime of your valve and actuator, therefore maximising your return on investment.

- Chemical incompatibility - This is the most common cause of diaphragm failure. It is therefore critical to select a diaphragm material that is compatible with the chemicals used in your process.
- Incompatible operating temperature - Using a diaphragm at a temperature higher than it is rated for can cause leaks as the material degrades or melts, which can in turn lead to valve and actuator damage.

Make sure that you select an elastomer for your process than can handle the temperatures of your process.

If you cannot find the cause of your diaphragm failure, please contact your local sales office.

10.1 Technical support

ASEPCO offers comprehensive after-sales service. If any adverse issue (such as material defect or valve function) develops with your valve, contact ASEPCO immediately to determine the most effective resolution for the issue.

For spare parts and advice regarding operation of your ASEPCO valve, contact your local sales office or visit www.wmftg.com.

11 Parts list

11.1 Replacement diaphragms

Material	0.5"	0.75"	1.0"	1.5"
Silicone	FS05	IS08	IS10	IS15
EPDM	FE05	IE08	IE10	IE15
EPDM Plus	FQ05	IQ08	IQ10	IQ15

11.2 Actuator maintenance kits

Manual actuators

Part #	Applicable To	Description
MAK-059	0.5" weirless manual actuator	Includes seals, hardware, and lubricant
MAK-089	0.75" weirless manual actuator	Includes seals, hardware, and lubricant
MAK-109	1.0" weirless manual actuator	Includes seals, hardware, and lubricant
MAK-159	1.5 weirless manual actuator	Includes seals, hardware, and lubricant

Pneumatic actuators

Part #	Applicable To	Description
PAK-058	0.5" weirless pneumatic actuator	Includes seals, hardware, and lubricant
PAK-088	0.75" weirless pneumatic actuator	Includes seals, hardware, and lubricant
PAK-108	1.0" weirless pneumatic actuator	Includes seals, hardware, and lubricant
PAK-158	1.5" weirless pneumatic actuator	Includes seals, hardware, and lubricant

12 Warranty

The following terms and conditions are applicable to all sales of ASEPCO valves. Any acceptance by ASEPCO of a purchase order for its valves is hereby made conditional upon the customer's acceptance of these terms and conditions of sales; including, in particular, any that are different from or in addition to or vary the terms contained in the customer's purchase order or request for quotation. Such acceptance shall be deemed to occur upon the failure of the customer to object in writing specifically to these terms and conditions within 14 days of receipt hereof. No waiver, alteration, or modification of these terms and conditions whether in the customer purchase order or otherwise shall be valid unless specifically accepted in writing by an authorised representative of ASEPCO.

Limitations of use

ASEPCO valves are designed for aseptic processing at not greater than their rated working pressure and within the temperature range designated by ASEPCO. ASEPCO disclaims the suitability for its valves for applications or types of service other than those for which they are intended, as indicated in ASEPCO specifications as supplied to the customer. ASEPCO also disclaims suitability of its valves for any use whatsoever, following an unsuccessful installation qualification protocol or after service without replacement of the diaphragm in accordance with ASEPCO recommendations. ASEPCO can only warrant performance when ASEPCO parts are used.

Warranty

ASEPCO warrants its products against defects in materials or workmanship for a period of three years from date of shipment for actuators and one year from date of shipment for all other components, excluding consumables, provided that they are used for a purpose and in a manner recommended or approved by ASEPCO. Warranty is contingent upon receipt and evaluation of the product by ASEPCO and determination by ASEPCO that the products or parts are found to be defective. In such case, the warranty obligation of ASEPCO shall not exceed the net sales price of the defective product or part. ASEPCO makes no warranty with respect to the products of other manufacturers which it may sell as part of an ASEPCO valve assembly.

ASEPCO makes no other warranty of any kind express or implied, and all implied warranties of merchantability and fitness for a particular purpose that exceed the aforementioned warranty are disclaimed by ASEPCO and excluded by this warranty. ASEPCO neither assumes nor authorises any person to assume for it, any other obligation in connection with the sale of its products. This warranty shall not apply to any products or parts that have been repaired or altered without prior authorisation by ASEPCO in writing; or have been subject to misuse of any kind including but not limited to contrary to ASEPCO instructions or recommendations. ASEPCO shall not be responsible for design defects due to inaccurate or incomplete information supplied by the customer or its representatives.

13 Information for returning products

In accordance with local Health and Safety Regulations, you are required to declare the substances which have been in contact with product(s) you return to WMFTG or its subsidiaries or distributors. Failure to do so will cause delays. Please ensure that you email this information and receive a RMA (Returned Material Authorisation) from your local sales office before you despatch the product(s). A copy of the RMA form must be attached to the outside of the packaging containing the product(s).

Please complete a separate decontamination certificate for each product and attach it to the outside of the packaging containing the product(s). A copy of the appropriate decontamination certificate can be downloaded from the WMFTG website at www.wmftg.com/support/decon

You are responsible for cleaning and decontaminating the product(s) before return.

When returning a valve or valve component to the factory, contact ASEPCO for a Return Material Authorisation (RMA) number. Package the valve or component carefully to prevent damage in transit. Please label boxes, packing slips, and all correspondence with the RMA number provided by ASEPCO.

14 Name and address of manufacturer

ASEPCO
1161 Cadillac Court,
Milpitas,
CA 95035

www.wmftg.com

To locate your local sales office, visit <http://www.wmftg.com/gb-en/contact-us/>

15 Trademarks

Copyright ©2020 ASEPCO Corporation. All rights reserved.

Radial-Diaphragm is a trademark of ASEPCO Corporation. All other trademarks and trade names are the property of their respective holders.

16 Publication history

m-weirlessdiaphragmvalve-en-02 Weirless Radial diaphragm™ in-line valve

First published 02.18

m-weirlessdiaphragmvalve-en-02 Weirless Radial diaphragm™ in-line valve

Revision 2 05.2020

17 Disclaimers

The information contained in this document is believed to be correct, but ASEPCO accepts no liability for any errors it contains and reserves the right to alter specifications without notice.

All warranties that might otherwise arise from the course of usage or trade are hereby expressly excluded and disclaimed. In no event shall ASEPCO be liable for special, incidental, exemplary, consequential, or indirect damages or for loss of anticipated profits to a customer, ex-customer, distributor, or any other person.



ASEPCO products should be used only in services and within pressure and temperature ranges designated in its product information or specifications or as specifically approved by ASEPCO in writing.

Misuse of ASEPCO products may result in personal injury or property damage. If any ASEPCO valve shows signs of leakage, do not operate—remove it from the line, and repair or replace it.