

Flexicon 520Di / 520DiN pumps



Contents

1	Declaration of conformity	3	19	Setup	66
2	Declaration of incorporation	4	19.1	Dosing	67
3	Warranty	5	19.2	Display	70
4	When you unpack your pump	6	19.3	Pump number	70
5	Information for returning pumps	7	19.4	Baud	71
6	Peristaltic pumps - an overview	8	19.5	Stop bits	71
7	Safety notes	9	19.6	Xon/Xoff	72
8	Pump specifications	11	19.7	Flow units	73
8.1	Dimensions	16	19.8	Date and time	74
9	Good pump installation practice	17	19.9	Max key operation	75
9.1	General recommendations	17	19.10	Outputs	76
9.2	Do's and do not's	17	19.11	Remote stop	79
10	Connecting to a power supply	19	19.12	Auto-restart	80
11	Start-up check list	22	19.13	Set maximum allowed speed	81
12	Switching on for the first time	22	19.14	Backlight	82
13	Switching on subsequently	24	19.15	ROM	82
14	Main menu	25	19.16	Pin out details	83
14.1	Keypad functions when not in manual mode	25	19.17	Language	85
14.2	Main menu entry	27	19.18	Defaults	85
15	PIN-secure process protection	28	19.19	Beep	86
16	Dose	30	19.20	Security code	86
16.1	Setting a dispense program	31	19.21	Exit	88
16.2	Loading a stored dispense program	42	20	Automatic control wiring	89
16.3	Starting a dispense program	43	20.1	IP31 Automatic control wiring	89
16.4	User and batch sequence	45	20.1.1	Run / stop input	90
16.5	While a dispense program is running	46	20.1.2	Direction input	91
16.6	To stop or pause a dispense program	51	20.1.3	Dose input	91
17	Calibrate	54	20.1.4	Leak detection input	92
18	Manual operation	60	20.1.5.1	Logic output 1	93
18.1	Keypad functions in manual mode	60	20.1.5.2	Logic output 2	94
18.2	Keypad beep	64	20.1.5.3	Logic output 3	95
18.3	Changing pump speed during manual operation	64	20.1.5.4	Logic output 4	95
18.4	Manual operation and remote digital inputs and outputs	65	20.1.6	Supply voltages	96
			20.2	IP66 Automatic control wiring	97
			20.2.1	520N module removal and replacement	97
			20.2.2	Wiring up	99
			20.2.3	Run / stop input	103
			20.2.4	Direction input	103
			20.2.5	Dose input	104
			20.2.6	Leak detection input	104
			20.2.7	Outputs 1, 2, 3, 4	105
			20.2.8	Supply voltages	106

21	Network control and operation	107	34	520R, 520R2 and 520RE installation	130
21.1	RS232 and RS485 command strings	111	34.1	Opening the pumphead guard	130
22	Connecting a computer	113	34.2	520R and 520R2: Tube loading	131
23	Troubleshooting	113	34.3	520RE: fitting the drain port	132
23.1	Error codes	114	34.4	520RE Element loading	133
24	Drive maintenance	115	34.5	520RE Element connection	135
25	Drive spares	115	35	520R, 520R2 and 520RE maintenance	136
26	The 505L pumphead	116	36	520R, 520R2 and 520RE rotor settings	137
26.1	505L Pumphead fitting and removal	116	37	Pumphead spares	138
27	505L tube loading	118	38	Flow rates	139
27.1	505L: Fitting double-Y tubing elements	119	39	Tubing and element part numbers	147
27.2	505L: Using twin inlet tubes	121	40	520 series pumping accessories	150
27.3	505L: Using two independent tubes	122	41	Trademarks	151
28	505L maintenance	123	42	Warning not to use pumps in patient-connected applications	151
29	505L track adjustment	124	43	Publication history	151
30	505L Pumphead spares	124	44	Decontamination certificate	152
31	505L Flow rates	125			
32	505L Tubing part numbers	126			
33	The 520R, 520R2 and 520RE pumpheads	127			
33.1	Pumphead position, removal and replacement	128			

1 Declaration of conformity



Watson-Marlow Ltd
Falmouth
Cornwall
TR11 4RU
England



EC Declaration of Conformity

Description	520/620 Liquid filling pump
Products	520Di or 620Di 520DiN or 620DiN
Conformity	Watson-Marlow Ltd declares that when this pump unit is used as a stand-alone pump it complies with Machinery Directive 2006/42/EC.
Standards	<p>Watson-Marlow Limited declares that the above stated products are in conformance with the following harmonised standards and directives:</p> <p>Low Voltage Directive 2006/95/EC. Electro-Magnetic Compatibility Directive 2004/108/EC. Safety of Machinery-Electrical equipment of machines; BS EN 60204-1 Safety requirements for electrical equipment for measurement, control and laboratory use; BS EN 61010-1 IEC 61010-1 UL 61010-1 Safety of machinery-Basic concepts, general principals of design BS EN ISO 12100-1 and BS EN ISO 12100-2 Degrees of protection provided by enclosures (IP code) BS EN 60529 Digital Data Communication BS EN 61138-2 Conducted emissions BS EN 55011 Class A Radiated emissions BS EN 55011 Class A Electrostatic discharge immunity BS EN 61000-4-2 Radiated RF immunity BS EN 61000-4-3 Fast transient/burst immunity BS EN 61000-4-4 Surge immunity testing BS EN 61000-4-5 Conducted RF immunity BS EN 61000-4-6 Voltage dips and interruptions BS EN 61000-4-11 Mains harmonics BS EN 61000-3-2</p>
Manufacturer	Watson-Marlow Limited, TR11 4RU, England
Date	24 April 2013
Signature	 David Cole, Managing Director, Watson-Marlow Limited

2 Declaration of incorporation



Watson-Marlow Ltd
Falmouth
Cornwall
TR11 4RU
England

Declaration of Incorporation

In accordance with the Machinery Directive 2006/42/EC that if this unit is to be installed into a machine or is to be assembled with other machines for installations, it shall not be put into service until the relevant machinery has been declared in conformity.

We hereby declare that:

Peristaltic Pump

Series: Flexicon liquid filling pump

that the following harmonized standards have been applied and fulfilled for health and safety requirements:

Safety of Machinery - EN ISO 12100

Safety of Machinery – Electrical Equipment of Machines EN 60204-1.

Quality Management System - ISO 9001.

and the technical documentation is compiled in accordance with Annex VII(B) of the Directive.

We undertake to transmit, in response to a reasoned request by the appropriate national authorities, relevant information on the partly completed machinery identified above. The method of transmission shall be by mail or email.

The pump head is incomplete and must not be put into service until the machinery into which it is to be incorporated has been declared in conformity with the provisions of the Directive.

Person authorized to compile the technical documents:

..... Andrew Green of Watson-Marlow Ltd.

Place and date of declaration: Watson-Marlow Ltd, 24 August 2013

Responsible person:

Mr. David Cole
Managing Director for Watson-Marlow Ltd

3 Five year warranty

520 cased pumps, 620 cased pumps and 720 cased pumps

For any 520, 620 or 720 cased pump purchased after 1 January 2007, Watson-Marlow Limited ("Watson-Marlow") warrants, subject to the conditions and exceptions below, through either Flexicon, its subsidiaries, or its authorised distributors, to repair or replace free of charge, any part of the product which fails within five years of the day of manufacture of the product. Such failure must have occurred because of defect in material or workmanship and not as a result of operation of the product other than in normal operation as defined in this pump manual.

Watson-Marlow shall not be liable for any loss, damage, or expense directly or indirectly related to or arising out of the use of its products, including damage or injury caused to other products, machinery, buildings, or property, and Watson-Marlow shall not be liable for consequential damages, including, without limitation, lost profits, loss of time, inconvenience, loss of product being pumped, and loss of production. This warranty does not obligate Watson-Marlow to bear any costs of removal, installation, transportation, or other charges which may arise in connection with a warranty claim.

Conditions of and specific exceptions to the above warranty are:

Conditions

- Products must be returned by pre-arrangement, carriage-paid, to Watson-Marlow, or a Watson-Marlow approved service centre.
- All repairs or modifications must have been made by Watson-Marlow Limited, or a Watson-Marlow approved service centre or with the express permission of Watson-Marlow.
- Warranties purporting to be on behalf of Watson-Marlow made by any person, including representatives of Watson-Marlow, its subsidiaries, or its distributors, which do not accord with the terms of this warranty shall not be binding upon Watson-Marlow unless expressly approved in writing by a Director or Manager of Watson-Marlow.

Exceptions

- The warranty shall not apply to repairs or service necessitated by normal wear and tear or for lack of reasonable and proper maintenance.
- All tubing and pumping elements as consumable items are excluded.
- Products which, in the judgment of Watson-Marlow, have been abused, misused, or subjected to malicious or accidental damage or neglect are excluded.
- Electrical surge as a cause of failure is excluded.
- Chemical attack is excluded
- All pumphead rollers are excluded.
- The 620R family of pumpheads are excluded from all warranty when pumping above 2 bar while above 165rpm.
- Pumpheads from the 313/314 and the Microcassette ranges and any 701 extension pumpheads are excluded and retain their one-year standard pumphead warranty. The drive they are attached to is subject to the five-year warranty as set out here.
- Ancillaries such as leak detectors are excluded.

4 When you unpack your pump

Unpack all parts carefully, retaining the packaging until you are sure all components are present and in good order. Check against the components supplied lists, below.

Packaging disposal

Dispose of packaging materials safely, and in accordance with regulations in your area. Pay particular attention to the expanded polystyrene shockproof shells. The outer carton is made of corrugated cardboard and can be recycled.

Inspection

Check that all components are present. Inspect components for damage in transit. If anything is missing or damaged, contact your distributor immediately.

Components supplied (520Di and 520DiN models)



- The 520Di or 520DiN pump drive unit fitted with:
 - 505L or other pumphead (see 8 *Pump specifications*) if specified as a pump
 - The designated mains power lead for your pump
- PC-readable CDROM containing these operating instructions
- Quick Start manual
- 520N washdown module providing ingress protection to IP66 NEMA 4X (520DiN only)

Note: Some versions of this product will include components different from those listed above. Check against your purchase order.

Storage

This product has an extended shelf life. However, care should be taken after storage to ensure that all parts function correctly. Users should be aware that the pump contains a battery with an unused life of seven years. Long-term storage is not recommended for peristaltic pump tubing. Please observe the storage recommendations and use-by dates which apply to tubing you may wish to bring into service after storage.

Di, DiN

5 Information for returning pumps

Equipment which has been contaminated with, or exposed to, body fluids, toxic chemicals or any other substance hazardous to health must be decontaminated before it is returned to Watson-Marlow or its distributor.

A certificate included at the rear of these operating instructions, or signed statement, must be attached to the outside of the shipping carton. This certificate is required even if the pump is unused. See 44 *Decontamination certificate*.

If the pump has been used, the fluids that have been in contact with the pump and the cleaning procedure must be specified along with a statement that the equipment has been decontaminated.

6 Peristaltic pumps - an overview

Peristaltic pumps are the simplest possible pump, with no valves, seals or glands to clog or corrode. The fluid contacts only the bore of a tube, eliminating the risk of the pump contaminating the fluid, or the fluid contaminating the pump. Peristaltic pumps can operate dry without risk.

How they work

A compressible tube is squeezed between a roller and a track on an arc of a circle, creating a seal at the point of contact. As the roller advances along the tube, the seal also advances. After the roller has passed, the tube returns to its original shape, creating a partial vacuum which is filled by fluid drawn from the inlet port.

Before the roller reaches the end of the track, a second roller compresses the tube at the start of the track, isolating a packet of fluid between the compression points. As the first roller leaves the track, the second continues to advance, expelling the packet of fluid through the pump's discharge port. At the same time, a new partial vacuum is created behind the second roller into which more fluid is drawn from the inlet port.

Backflow and siphoning do not occur, and the pump effectively seals the tube when it is inactive. No valves are needed.

The principle may be demonstrated by squeezing a soft tube between thumb and finger and sliding it along: fluid is expelled from one end of the tube while more is drawn in at the other.

Animal digestive tracts function in a similar way.

Suitable applications

Peristaltic pumping is ideal for most fluids, including viscous, shear-sensitive, corrosive and abrasive fluids, and those containing suspended solids. They are especially useful for pumping operations where hygiene is important.

Peristaltic pumps operate on the positive displacement principle. They are particularly suitable for metering, dosing and dispensing applications. Pumps are easy to install, simple to operate and inexpensive to maintain.

7 Safety notes

In the interests of safety, this pump and the tubing selected should only be used by competent, suitably trained personnel after they have read and understood this manual, and considered any hazard involved. If the pump is used in a manner not specified by Watson-Marlow Ltd, the protection provided by the pump may be impaired.

Any person who is involved in the installation or maintenance of this equipment should be fully competent to carry out the work. In the UK this person should also be familiar with the Health and Safety at Work Act 1974.



This symbol, used on the pump and in this manual, means: Caution, refer to accompanying documents.



This symbol, used on the pump and in this manual, means: Do not allow fingers to contact moving parts.



This symbol, used on the pump and in this manual, means: Recycle this product under the terms of the EU Waste Electrical and Electronic Equipment (WEEE) Directive.



Fundamental work with regard to lifting, transportation, installation, starting-up, maintenance and repair should be performed by qualified personnel only. The unit must be isolated from mains power while work is being carried out. The motor must be secured against accidental start-up.



There is a user-replaceable type T2,5A H 250V fuse in the fuseholder in the centre of the switch-plate at the back of the pump. In some countries, the mains power plug contains an additional replaceable fuse. There is a fuse on the interface card which self-resets after five seconds. There are no user-serviceable fuses or parts inside this pump.

There are moving parts inside the pumphead. Before opening the tool-unlockable pumphead guard, ensure that the following safety directions are followed.

- Ensure that the pump is isolated from the mains power.
- Ensure that there is no pressure in the pipeline.
- If a tube failure has occurred, ensure that any fluid in the pumphead has been allowed to drain to a suitable vessel, container or drain.
- Ensure that protective clothing and eye protection are worn if hazardous fluids are pumped.
- Primary operator protection from rotating parts of the pump is provided by the pumphead safeguard. Note that safeguards differ, depending on the type of pumphead. Refer to the Pumpheads sections of this manual.

This pump must be used only for its intended purpose.

The pump must be accessible at all times to facilitate operation and maintenance. Access points must not be obstructed or blocked. Do not fit any devices to the drive unit other than those tested and approved by Watson-Marlow. Doing so could lead to injury to persons or damage to property for which no liability can be accepted.

If hazardous fluids are to be pumped, safety procedures specific to the particular fluid and application must be put in place to protect against injury to persons.

The exterior surfaces of the pump may get hot during operation. Do not take hold of the pump while it is running. Let it cool after use before handling it. The drive unit must not be run without a pumphead fitted.



This product does not comply with the ATEX directive and must not be used in explosive atmospheres.

Di, DiN

8 Pump specifications

DiN

Labels fixed to the rear of the pump contain manufacturer and contact details, product reference number, serial number and model details.

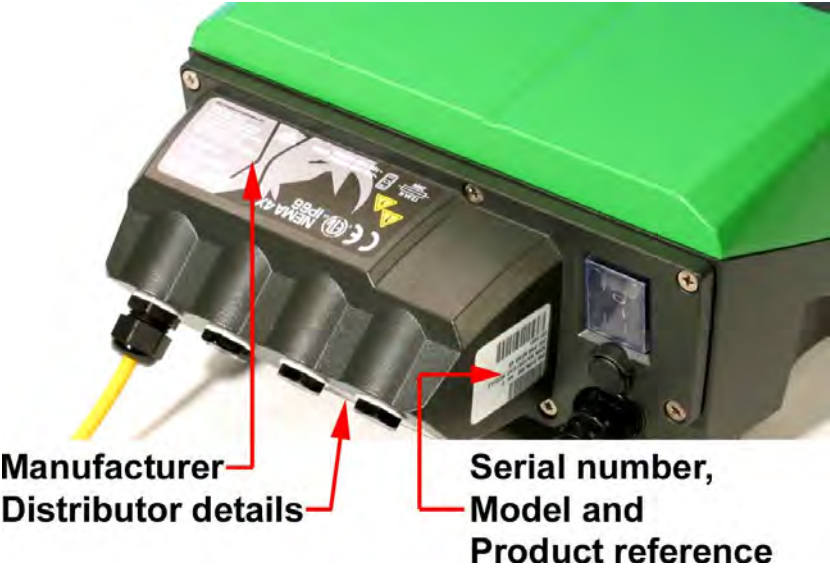

Di, DiN

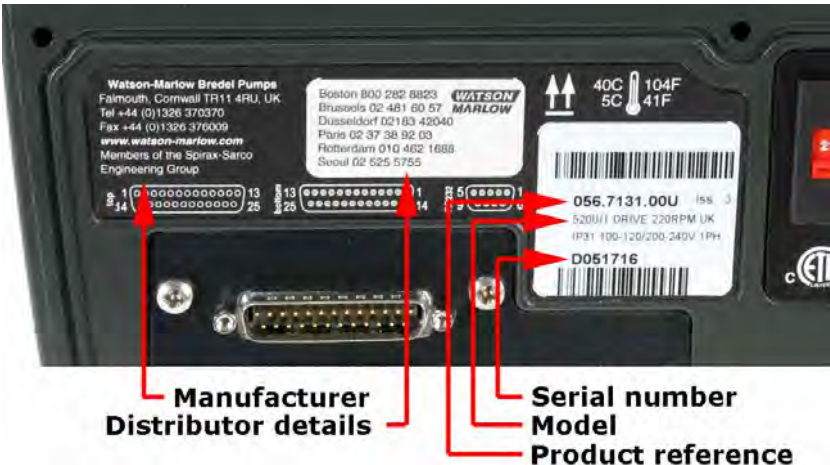

Di

520Di, IP31 model

This pump can be controlled from the keypad or remotely. It features:

Manual control

Speed adjustment; run and stop; direction control; "max" key for rapid priming.

Remote control

The pump can be digitally controlled with a contact closure or logic input signal to operate the pump.

Outputs

There are four digital status outputs which can be configured in software for a variety of pump parameters.

Calibration

Full calibration, plus default figures for a range of pumpheads and tubes. Calibration dose facility.

RS232 serial communications

Full pump control from a PC or other controller with the ability to network up to 32 pumps. **A computer can be connected to the pump to make (and print) records of dispensed batches.**

Dispensing feature

Batch or single-dose dispensing, including dose size and number, interval, start and end ramp and drip control.

DiN

520DiN, IP66 model

This pump can be controlled from the keypad or remotely. It features:

Manual control

Speed adjustment; run and stop; direction control; "max" key for rapid priming.

Remote control

The pump can be digitally controlled with a contact closure or logic input signal to operate the pump.

Outputs

There are four 24V relay status outputs which can be configured in software for a variety of pump parameters.

Calibration

Full calibration, plus default figures for a range of pumpheads and tubes. Calibration dose facility.

RS485 serial communications

Full pump control from a PC or other controller with the ability to network up to 32 pumps. **Computer recording of dispensed batches is not possible under RS485.**

Dispensing feature

Batch or single-dose dispensing, including dose size and number, interval, start and end ramp and drip control.

IP (Ingress Protection) and NEMA definitions

IP		NEMA
1st Digit	2nd Digit	
3 Protected against ingress of solid objects with a diameter of more than 2.5mm. Tools, wires etc with a thickness of more than 2.5mm are prevented from approach	1 Protection against dripping water falling vertically. No harmful effect must be produced	2 Indoor use to provide a degree of protection against limited amounts of falling water and dirt
5 Protected against harmful dust deposits. Ingress of dust is not totally prevented but the dust must not enter in sufficient quantity to interfere with satisfactory operation of the equipment. Complete protection against contact	5 Protection against water projected from a nozzle against the equipment (enclosure) from any direction. There must be no harmful effect (water jet)	12 Indoor use to provide a degree of protection against dust, falling dirt and dripping, non-corrosive liquids
		13 Indoor use to provide a degree of protection against dust and spraying water, oil and non-corrosive coolants
6 Protection against ingress of dust (dust-tight). Complete protection against contact	6 Protection against heavy seas or powerful water jets. Water must not enter the equipment (enclosure) in harmful quantities (splashing over)	4X Indoor or outdoor* use to provide a degree of protection against splashing water, wind-blown dust and rain, hose-directed water; undamaged by the formation of ice on the enclosure. (Resist corrosion: 200-hour salt spray)

* 520N cased pumps are rated to NEMA 4X (indoor use) only.

Pump specifications

Control range (turndown ratio)	0.1-350rpm (3,500:1)
Supply voltage/frequency	100-120V/200-240V 50/60Hz 1ph
Maximum voltage fluctuation	±10% of nominal voltage. A well regulated electrical mains supply is required along with cable connections to the best practice of noise immunity
Installation category (overvoltage category)	II
Power consumption	135VA
Full load current	<0.6A at 230V; <1.25A at 115V
Eprom version	Accessible through pump software
Enclosure rating	520Di: IP31 to BS EN 60529. Equivalent to NEMA 2, suitable for indoor use. Protected against dripping water and falling dirt. May be wiped with a damp cloth, but should not be immersed 520DiN: IP66 to BS EN 60529; NEMA 4X to NEMA 250*
Pumphead options	520R, 501RL, 313, 314, 505L, 505BA, 505CA, 314MC, 318MC
Operating temperature range	5C to 40C, 41F to 104F
Storage temperature range	-40C to 70C, -40F to 158F
Maximum altitude	2,000m, 6,560ft
Humidity (non-condensing)	80% up to 31C, 88F, decreasing linearly to 50% at 40C, 104F
Pollution degree	2
Noise	<70dB(A) at 1m

* Protect from prolonged UV exposure.

Note: 520 drive models are c ETL us listed. Cert to std CAN/CSA C22.2 No 1010-92. Conforms to std UL 61010A-1.

Standards

EC harmonised standards	Safety of machinery—electrical equipment of machines: BS EN 60204-1	
	Safety requirements for electrical equipment for measurement, control and laboratory use: BS EN 61010-1 incorporating A2 Category 2, Pollution degree 2	
	Degrees of protection provided by enclosures (IP code): BS EN 60529 amendments 1 and 2	
	Conducted emissions: BS EN 55011 A1 and A2 Class A	
	Radiated emissions: BS EN 55011 A1 and A2 Class A	
	Electrostatic discharge: BS EN 61000-4-2	
	Radiated RF immunity: BS EN 61000-4-3 A1 and A2	
	Fast transient burst: BS EN 61000-4-4 A1 and A2, Level 3 (2kV)	
	Surge immunity: BS EN 61000-4-5 A1 and A2	
	Conducted RF immunity: BS EN 61000-4-6	
	Voltage dips and interruptions: BS EN 61000-4-11	
	Mains harmonics: BS EN 61000-3-2 A2	
	Other standards	UL 61010A-1
		CAN/CSA-C22.2 No 61010-1
Conducted emissions FCC 47CFR, Part 15.107		
Radiated emissions FCC 47CFR, Part 15		
NEMA 4X to NEMA 250 (indoor use) for IP66 products only		

8.1 Dimensions

520DiN IP66 model; 520R pumphead

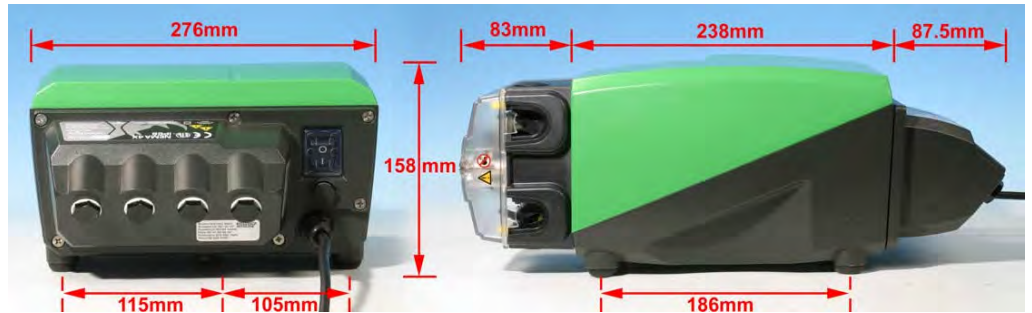

520DiN IP66 model; 505L pumphead

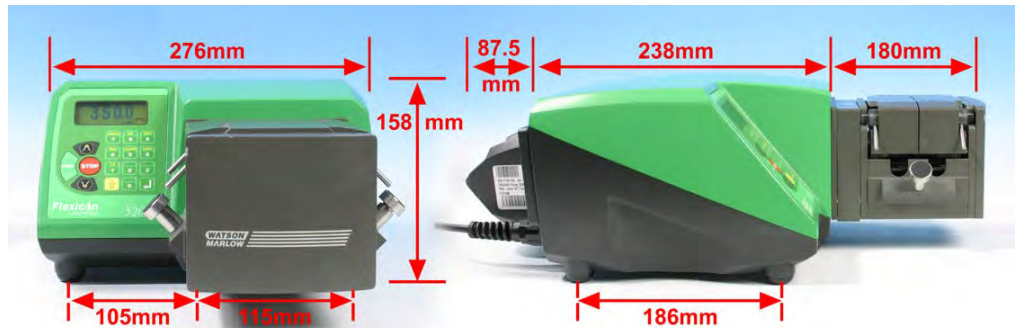

Note: 520Di IP31 pumps are the same size except that they lack the 520N module at the rear of the pump.

Unit weights

	Drive only	+ 520R, 520R2	+ 520REL, 520REM, 520REH	+ 505L
520DiN: IP66, NEMA 4X	10.58kg 23lb 5oz	11.48kg 25lb 5oz	11.40kg 25lb 2oz	13.06kg 28lb 13oz
520Di: IP31	9.70kg 21lb 6oz	10.60kg 23lb 5oz	10.52kg 23lb 3oz	12.18kg 26lb 14oz

9 Good pump installation practice

9.1 General recommendations

A correctly engineered installation will promote long tube life. Site the pump on a flat, horizontal, rigid surface, free from excessive vibration, to ensure correct lubrication of the gearbox. Allow a free flow of air around the pump to ensure that heat can be dissipated. Ensure that the ambient temperature around the pump does not exceed 40C.

The **STOP** key on the keypad will always stop the pump. However, it is recommended that a suitable local emergency stop device is fitted into the mains supply to the pump.

The pump may be set up so that the direction of rotor rotation is clockwise or counter-clockwise, whichever is convenient. Please note, however, that for the 520R and 501RL pumpheads tube life will be greater if the rotor rotates clockwise; and that performance against pressure will be maximised if the rotor rotates counter-clockwise. To achieve 4 bar and 7 bar pressures using a 520RE pump and the appropriate rotor and element, the pump **must** rotate counter-clockwise.

Peristaltic pumps are self-priming and self-sealing against backflow. No valves are required in inlet or discharge lines, except as described below. Valves in the process flow must be opened before the pump operates. Users are advised to fit a pressure relief device between the pump and any valve on the discharge side of the pump to protect against damage caused by accidental operation with the discharge valve closed. Users of 520RE pumps at pressures up to 4 bar and 7 bar are advised to fit a non-return valve between the pump and the discharge pipework to avoid the sudden release of pressurised fluid in the unlikely event of element failure.

9.2 Do's and do not's

Do not build a pump into a tight location without adequate airflow around the pump.

Do not strap the control and mains power cables together.

Do keep delivery and suction tubes as short and direct as possible - though ideally not shorter than 1m - and follow the straightest route. Use bends of large radius: at least four times the tubing diameter. Ensure that connecting pipework and fittings are suitably rated to handle the predicted pipeline pressure. Avoid pipe reducers and lengths of smaller bore tubing than the pumphead section, particularly in pipelines on the suction side. Any valves in the pipeline (not usually needed with a self-priming peristaltic pump) must not restrict the flow. Any valves in the flow line must be open when the pump is running.

Do use suction and delivery pipes equal to or larger than the bore of the tube in the pumphead. When pumping viscous fluids use pipe runs with a bore several times larger than the pump tube.

Do ensure that on longer tube runs at least 1m of smooth bore flexible tubing is connected to the inlet and discharge port of the pumphead to help to minimise impulse losses and pulsation in the pipeline. This is especially important with viscous fluids and when connecting to rigid pipework.

Do site the pump at or just below the level of the fluid to be pumped if possible. This will ensure flooded suction and maximum pumping efficiency.

Do keep the pumphead track and all moving parts clean and free from contamination and debris.

Do run at slow speed when pumping viscous fluids. When using the 520R pumphead, a 6.4mm or 4.8mm bore tube with a 2.4mm wall will give best results. Tube smaller than this will generate a high friction loss, so reducing the flow. Tube with a larger bore may not have sufficient strength to re-stitute fully. Flooded suction will enhance pumping performance in all cases, particularly for materials of a viscous nature.

Do calibrate after changing pump tubes, fluid, or any connecting pipework. It is also recommended that the pump is calibrated periodically to maintain accuracy.

520Di models may be wiped with a wet cloth, but should not be hosed or immersed. The front of IP31 models is further protected against light spillages onto the pump.

520DiN models may be hosed down, but should not be immersed. Protect from prolonged UV exposure.

When using Marprene or Bioprene continuous tubing, **do** re-tension the tube after the first 30 minutes of running.

Tube selection: The chemical compatibility lists published in Watson-Marlow publications are guides. If in doubt about the compatibility of a tube material and the duty fluid, request a Watson-Marlow tube sample card for immersion trials.

10 Connecting this product to a power supply



Set the voltage selector to 115V for 100-120V 50/60Hz supplies or 230V for 200-240V 50/60Hz supplies. Always check the voltage selector switch before connecting the mains supply.

Make suitable connection to an earthed single-phase mains electricity supply.



We recommend using commercially available supply voltage surge suppression where there is excessive electrical noise.

Power cable: The pump is supplied fitted with a cable gland and approximately 2.8m of power cable. Recommended cable: H05RN-F3G0.75; SJTW 105C 3-18AWG; max OD 8mm (5/16in).

This drawing shows the cable connections from below with the interface card cover removed.

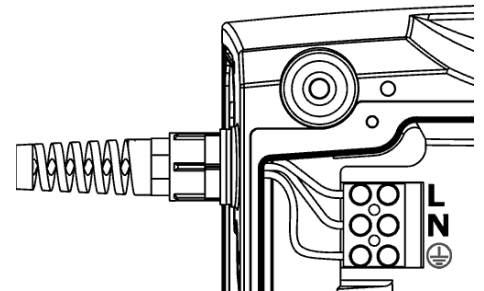

DiN

Power cables of NEMA 4X specification pumps are fitted with a standard US mains power plug. IP66 specification pumps are supplied with no plug. The colour code for the power cable is: brown - live; blue - neutral; green and yellow - earth.

Di, DiN

If the mains power cable is inappropriate for your installation, it can be changed.

- Ensure that the pump is isolated from the mains power.



- Remove the six screws from the interface card cover underneath the pump. Lift off the interface card cover. You may find it convenient to remove the cover completely; if so, remove the cover earth lead.
- Undo the terminal block connectors. Remove the restraining clip by sliding its jaws sideways in opposite directions.
- Loosen the cable gland using a 19mm wrench and remove the gland and the cable.
- Thread a replacement cable through the three parts of the gland, the pump case and the restraining clip. Connect the new cable to the block connectors, following the drawing above.
- Tighten the restraining clip and the gland to 2.5Nm. Check that the card cover earth link is secure. Replace the card cover, checking that the earth wire is not pinched beneath the cover lip. Take care that the sealing strip is properly seated to ensure a seal.



Input line fusing: type T2,5A H 250V 20mm time-delayed fuse, located in a fuseholder in the centre of the switchplate at the rear of the pump.

Power interruption: This pump has an auto-restart feature which, when active, will restore the pump to the operating state it was in when power was lost. See 19.12 *Auto-restart*.

Stop / start power cycles: Do not power up/power down for more than 100 starts per hour, whether manually or by means of the auto-restart facility. We recommend remote control where a high frequency of power cycles is required.

11 Start-up check list

Note: See also 27 505L: Tube loading and 34.2 520R and 520R2: Tube loading.

- Ensure that proper connections are achieved between the pump tube and suction and discharge piping.
- Ensure proper connection has been made to a suitable power supply.
- Ensure that the recommendations in the section 9 *Good pump installation practice* are followed.

12 Switching the pump on for the first time

Note: This manual uses **bold** type to highlight the active option in menu screens: “**English**” in the first screen represented here. The active option appears on the pump display in **inverse** text.

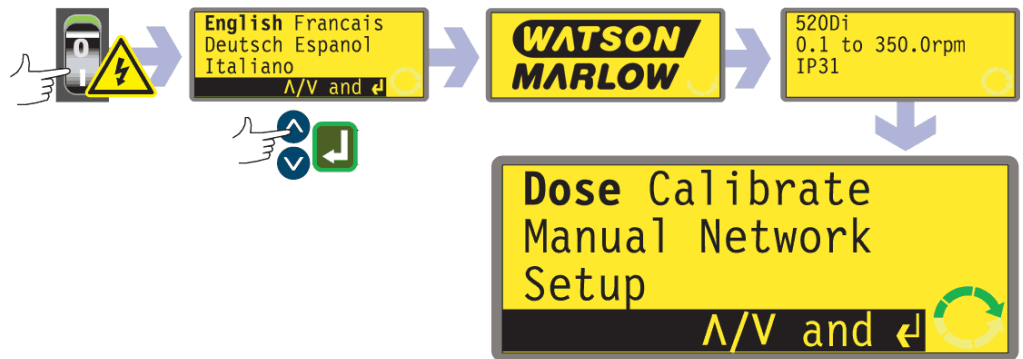

- Switch on the power supply at the rear of the pump. The pump runs a power-on test to confirm proper functioning of the memory and hardware. If a fault is found, an error message is displayed. See 23.1 *Error codes*.
- The pump displays a language menu. Use the **UP** and **DOWN** keys to select your language. Press the **ENTER** key to confirm your choice.
The information which follows assumes that your choice was English. When the language is chosen this menu will not appear again and all menus will appear in the language you chose. (Language can be reset as described later. See 19.17 *Language*.)
- The pump displays the Watson-Marlow start-up screen for three seconds, followed by the pump model identity screen for three seconds (it shows 520Di for 520Di and 520DiN models), and then the Main menu screen.
- The rotation symbol on the display indicates clockwise rotation. The speed of rotation is the pumphead’s maximum. Other initial start-up operational parameters are listed in the table below.

First-time start-up defaults			
Language	Not set	Remote stop	Open=run
Speed	300 rpm	Pump number	1
Direction	Clockwise	Baud rate	9600
Pumphead	505L	Stop bits	2
Tube size	9.6mm	Xon/Xoff	Off
Calibration	from head and tube table	Dose programs	None
Backlight	On	Output 1	Run/Stop *
Keypad lock	Off	Output 2	Auto/Man ‡
Auto-restart	Off	Output 3	General alarm
Scaling	Off	Output 4	
Pump status	Stopped		
Beeper	On		
Security code	Not set	Dose *	= high
Max (prime)	Standard setting	Clockwise rotation †	= high
		Auto ‡	= high

Note: The settings shown above for Dose, Clockwise rotation and Net are those in force on initial start-up for the functions available on Output 1, Output 2 and Output 3 respectively. For example, a high signal on Output 2 indicates clockwise rotation. These can be exchanged later according to user requirements.

The pump is now ready to operate according to the defaults listed above.

All operating parameters may be changed by means of key-presses.

13 Switching the pump on in subsequent power cycles (if not in auto-restart mode)

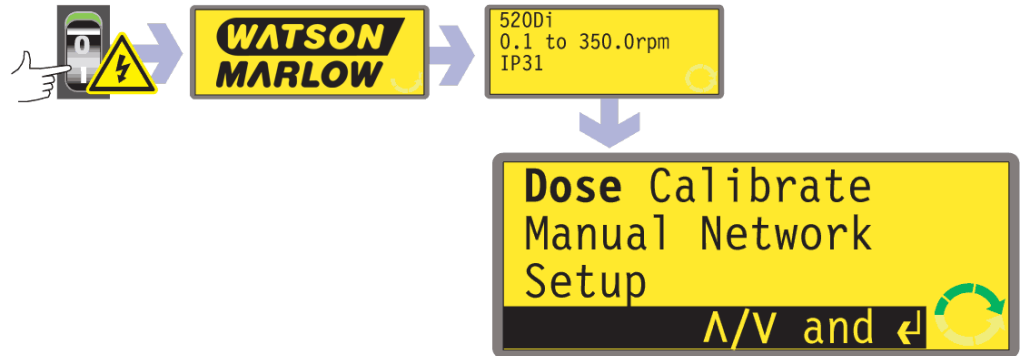

- Switch on the power supply at the rear of the pump. The pump runs a power-on test to confirm proper functioning of the memory and hardware. If a fault is found, an error message is displayed. See 23.1 *Error codes*.
- The pump displays the Watson-Marlow start-up screen for three seconds followed by the pump model identity screen for three seconds (it shows 520Di for 520Di and 520DiN models), and then the Main menu screen.
Note: If ANY key is pressed during the display of any of the preliminary screens, the display jumps to the next screen. Quickly pressing any two keys or any key twice immediately after switch-on causes the display to jump to the manual mode main screen. Once in the Main menu screen, keys assume their normal functions - see 14.1 *Keypad functions when not in Manual mode* and 18.1 *Keypad functions in Manual mode* below.
- Start-up defaults are those in place when the pump was switched off last. Check that the pump is set to operate as you require it.

The pump is now ready to operate.

14 Main Menu

14.1 Keypad functions when not in manual mode

- **STOP**: While a dose is running, **STOP** pauses the current dose and stops the pump. **STOP** also functions as a “go back” key, taking the user up one menu level without making a change. During numeric entry, **STOP** clears the current value or restores it to its value on entry to that screen, allowing numeric entry to continue.
- **UP**: The **UP** key is used in menu item selection: it moves a highlight up a menu. In save program mode, it scrolls through 9-0, “space” then Z-A in a circular list.
- **DOWN**: The **DOWN** key is used in menu item selection: it moves a highlight down a menu. In save program mode, it scrolls through A-Z, “space” then 0-9 in a circular list.
- **START**: The **START** key begins a dose.
- **ENTER**: The **ENTER** key functions in a similar way to the “enter” key of a personal computer: it confirms keypresses made immediately before. In menu item selection, it triggers the action or display selected from a menu using the **UP** and **DOWN** keys.
- **0, 1, 2, 3, 4, 5, 6, 7, 8, 9**: numeric keys are used to enter numbers when a screen asks for numeric input.
- **SHIFT**: Pressing the **SHIFT** key displays an arrow symbol in the lower left corner of the screen, indicating that the next keypress will be in Shift mode. Pressing the **SHIFT** key, then pressing **0, 1, 4, 5, 6, 7, 8** or **9** invokes the action indicated in yellow on those keys, and then cancels Shift mode. If the **SHIFT** key is pressed in error, Shift mode may be cancelled by a second press on the **SHIFT** key.



SHIFT, 0 (.)

enters a decimal point in a numeric expression. The number "10.55", for example, is entered by pressing **1, 0, SHIFT, 0, 5, 5**.

SHIFT, 1 (DIRECTION)

toggles the direction of rotation shown on the display during dispense program setup. When the dispense program is started, the pump rotates in the new direction.

SHIFT, 4 (MAX)

while the pump is in Manual mode or Dose mode at the dose start screen, causes the pump to re-prime itself. If **Always enabled** has been selected (see 19 *Setup*) it also causes the pump to prime itself in Calibrate mode and in Dose mode while the pump is stopped. It has no effect in Network or Setup modes.

SHIFT, 5 (CLEAR)

during numeric entry, clears the current value or restores it to its value on entry to that screen, allowing numeric entry to continue. Has no effect in other modes.

SHIFT, 6 (LOAD)

when the pump is stopped, allows the recall of a dose program from the pump's memory. Has no effect if no program has been stored. Has no effect in Network, Calibration and Setup modes, nor if a numeric entry is called for, a dose parameter is being modified, a program is being saved or if a dose is running.

SHIFT, 7 (MENU)

displays the Main menu. It operates at any point in the pump's activity except when numeric entry is required or if a dose is running.

SHIFT, 8 (CAL)

when the pump is stopped, begins a full calibration sequence (see 17 *Calibrate*). Has no effect in Setup and Network modes. While the pump is dispensing a dose, **SHIFT, 8 (CAL)** allows a change to the dose size (within 25%) called recalibration - which will take effect on the next full dose.

SHIFT, 9 (INFO)

causes the pump to display the volume of fluid it has dispensed since being set to zero or calibrated. In Dose mode, **SHIFT, 9 (INFO)** causes the pump to display the volume of fluid it has dispensed since being set to zero or calibrated, and how many doses per hour it is currently achieving. In both cases, the information is displayed only while **SHIFT, 9 (INFO)** is pressed and held. If **STOP** is pressed while the information screen is displayed, the volume dispensed figure and the doses per hour figure are reset to zero.

SHIFT, UP

has no effect.

SHIFT, DOWN

has no effect.

Note: Confirmation screens are displayed for 4 seconds. While they are displayed, a single press on any key removes them.

14.2 Main menu entry

SHIFT, 7 (MENU) displays the Main menu. It operates at any point in the pump's activity except when numeric entry is required or if a dose is running.

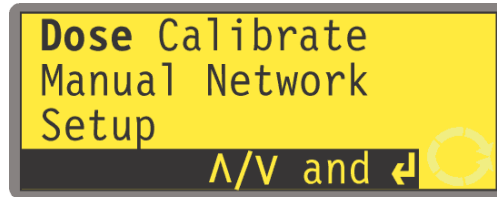

The Main menu offers five options: **Dose, Calibrate, Manual, Setup** and **Network**. Use the **UP** and **DOWN** keys to make a choice. Press the **ENTER** key to confirm your decision.

Dose

Except when under manual control, all pump activity is controlled by dispense programs. Selecting **Dose** allows the user to create, amend or select a dispense program, and instruct the pump to carry it out. The pump will stop if **STOP** is pressed, but is otherwise under the control of the dispense program.

Calibrate

Selecting **Calibrate** allows the user to calibrate the pump with default figures for a range of pumpheads and tubes, as well as to refine the flowrate figures with a calibration dose facility.

Manual

Selecting **Manual** allows the user to start, control and stop the pump by means of keypresses.

Setup

Selecting **Setup** allows the user to set the pump's operating parameters under 20 headings: **Dosing, Display, Pump I/D, Baud, Stop bits, Xon/Xoff, Units, Date/time, Max, Outputs, Remote stop, Auto-restart, Set max Speed, Pin out details, Backlight, ROM, Language, Defaults, Beep,** and **Security code**.

Network

Selecting **Network** places the pump under external control, using RS232 (520Di) or RS485 (520DiN) network communications.

15 PIN-secure process protection

The 520DiN and 520Di feature PIN-secure process protection. This allows the pump to be configured to suit the application, and for the setup to be protected by two levels of PIN code. See 19.20 *Security code setup*.

Menu option or keypress	With Main code set	With User code set	Code set and keypad locked
Menu	Available	Available	Not available
Calibrate	Available	Available	Not available
Accept	Available	Available	Not available
Change	Main PIN needed	Main PIN or User PIN needed	Not available
Setup	Main PIN needed	Main PIN needed; User PIN invalid	Not available
Dose	Main PIN needed	Main PIN needed; User PIN invalid	Not available
Manual	Available	Available	Not available
Network	Available	Available	Not available
Cal (SHIFT, 8)	Available	Available	Not available
Accept	Available	Available	Not available
Change	Main PIN needed	Main PIN or User PIN needed	Not available
Max (SHIFT, 4)	Available	Available	Not available
Dir (SHIFT, 1)	Main PIN needed	Main PIN or User PIN needed	Not available
Info (SHIFT, 9)	Available	Available	Not available
Load (SHIFT, 6)	Available	Available	Not available
Proceed	Available	Available	Not available
Review program	Available	Available	Not available
Delete program	Main PIN needed	Main PIN needed; User PIN invalid	Not available
Clear (SHIFT, 5)	Available	Available	Not available
Up	Available	Available	Not available
Down	Available	Available	Not available
SHIFT and Up	Available	Available	Not available
SHIFT and Down	Available	Available	Not available
Start	Available	Available	Available
Stop	Available	Available	Available
Enter	Available	Available	Not available
Keypad lock	Main PIN needed	Main PIN or User PIN needed	Main PIN or User PIN needed
Auto-restart	Available	Available	Available

The main code allows changes to **Calibrate, Setup, Dose, Direction** and **Keypad lock**.

The secondary (User) code permits **Calibrate, Direction** change and **Keypad lock** but bars **Setup** and **Dose** change.

If either code is used in conjunction with Keypad lock, all keys are disabled except **STOP** and **START**.

To activate and set a security code, see 19.20 *Security code setup*.

If the main code is lost or forgotten: The Setup main security code can be bypassed by entering a special key sequence; all codes can then be cancelled and reset. Contact Watson-Marlow or your distributor for details.

16 Dose

Dose mode allows the setup, storage and use of up to 50 different dispense programs. A complete dosing sequence, with all its parameters set, can be initiated by pressing **START** or closing a remote switch.

The dosing parameters are: pumthead type, tube size, calibrated flow, dose size, speed and direction, pause interval, number of doses, start/end ramps and drip adjustment.

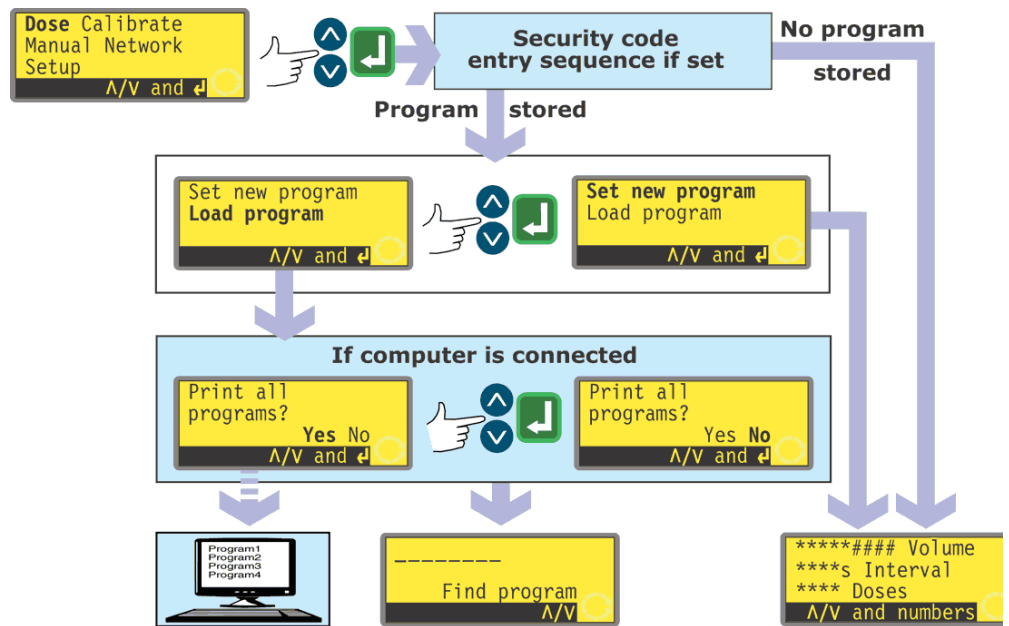

- Use the **UP** and **DOWN** keys to highlight **Dose** in the Main menu. Press **ENTER** to confirm.
- If no dispense program has been saved, the pump displays the first screen of the Set dose program sequence, via the security code entry sequence if one has been set.
- If the pump has stored one or more dose programs, the pump invites the user to set a new program or use an existing one, via the security code entry sequence if one has been set. Use the **UP** and **DOWN** keys to highlight **Set new program** or **Load program**. Press **ENTER** to confirm.
- If **Set new program** is selected, the pump displays the first screen of the Set dose program sequence.
- If **Load program** is selected, the pump displays the Find program screen (see 16.2 *Loading a stored dispense program*), via an offer to display the available programs on a personal computer if one is connected (520Di only). See 22 *Connecting a computer*.

Alternatively ...

Press **SHIFT, 6 (LOAD)** to display the Find program screen (if one or more dispense programs have been stored). This shortcut is not available if the pump is in Calibrate mode, numeric entry mode, is modifying a dose parameter, saving a program or if a dose is running.

Di, DiN

16.1 Setting a dispense program

Default dispense program settings are:

Pump-head	Tube size	Dose size	Dose interval	Number of doses	Speed	Direction	Start ramp	End ramp	Drip
505L	9.6mm bore	25.0 ml	0	10	300	CW	0	0	0

Note: These settings will be restored if the pump is restored to factory defaults.

The Calibration section of this instruction manual (see 17 *Calibrate*) lists the pump-head and tube size options available, and describes how to tell the pump's software which pumphead and tube are in use. This section of the manual assumes that the user has already chosen his pumphead and tube, and calibrated the pump accordingly.

Setting a new dispense program is the process of changing any or all of the default settings - or of the current settings, if any have previously been changed (apart from pumphead and tube size) - and saving the changed suite of settings as a new dispense program.

The Dispense program parameters menu occupies several screens.

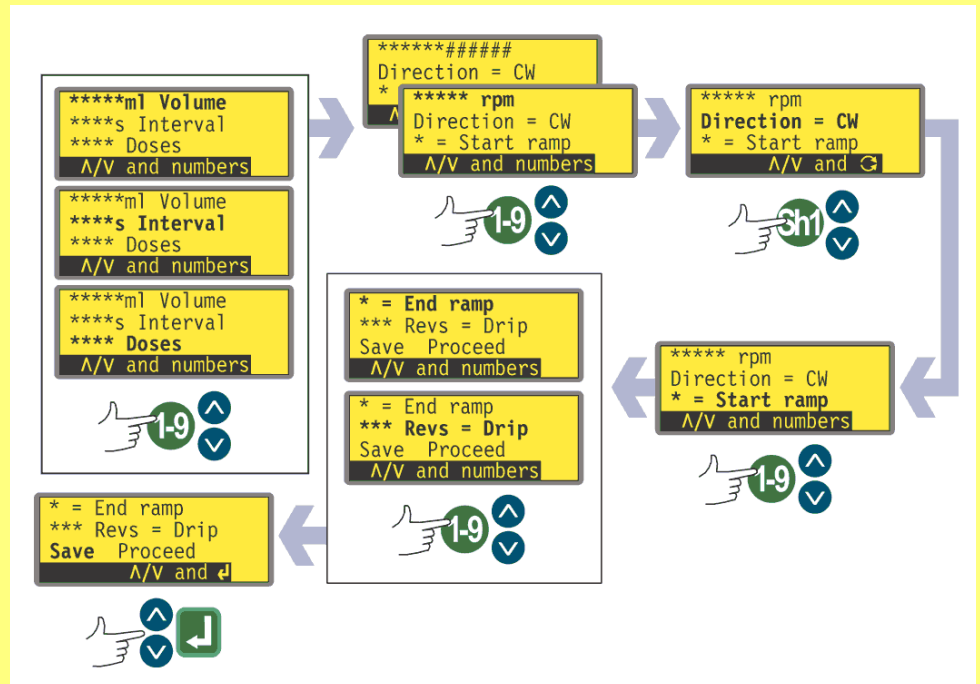

To move from one screen to subsequent screens, repeatedly press **DOWN**. Each item is highlighted in turn until the last item on the screen is highlighted. A further press on the **DOWN** key displays the next screen of the menu, with the first item highlighted.

Follow the reverse procedure using the **UP** key to move to an item on a previous screen of the menu.

Select a parameter using the **UP** or **DOWN** keys. The values shown are the default values or those set for the current dispense program. As each parameter is highlighted, you may accept or change its value.

- If it is correct, do nothing. **UP** and **DOWN** highlight the next parameter.
- If you wish to change it, do so using the keys indicated as available in the bottom line of the screen. When the value is correct, use the **UP** or **DOWN** keys to move to the next parameter.
- **At any time during the dose setup sequence the user may press START and the pump may be operated according to the parameters in force. If the next batch requires only the dose size to be changed from the last batch, for example, change it and press START, ignoring the other parameters.**
- The last two items on the last screen of the menu are **Save** and **Proceed**. If the user has made all the required changes, he may save the new settings by highlighting **Save** using the **UP** or **DOWN** keys and pressing **ENTER** to confirm; or he may proceed to run the new program according to the parameters in force by highlighting **Proceed** using the **UP** or **DOWN** keys and pressing **ENTER** to confirm. The amended program will not have been saved and cannot be re-run without re-entering the changes made.



In this programming area, pressing SHIFT, 5 (CLEAR) while setting up dosing parameters returns the value being changed to its original setting, allowing the user to start again.

Dose volume if the units are set to volume

See 19.7 *Setup, Flow units*.



- Use the **UP** and **DOWN** keys to highlight the **Volume** line of the display (the top line, first screen). The units shown are those chosen during the Setup sequence. See 19 *Setup*.
- If the dose volume displayed is correct, do nothing. **UP** and **DOWN** highlight the next or previous parameter.
- If you wish to change the dose volume, use the numeric keys to enter a new volume. Example figures are shown here. To quickly return to the starting value, press **SHIFT, 5 (CLEAR)**. When the dose volume is correct, press **ENTER** to confirm and use the **UP** and **DOWN** keys to highlight the next parameter. **DOWN** is assumed here.

Dose volume if the units are set to weight

See 19.7 Setup, Flow units.

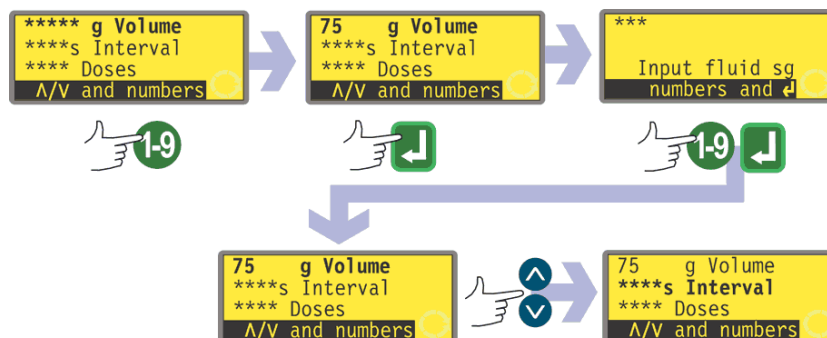

- Use the **UP** and **DOWN** keys to highlight the weight line of the display (the top line, first screen - still called **Volume**). The units shown are those chosen during the Setup sequence. See 19 Setup.
- If the dose weight displayed is correct, do nothing. **UP** and **DOWN** highlight the next or previous parameter.
- If you wish to change the dose weight, use the numeric keys to enter a new weight. Example figures are shown here. To quickly return to the starting value, press **SHIFT, 5 (CLEAR)**. When the dose weight is correct, press **ENTER** to confirm.
- The pump invites you to enter the specific gravity of the duty fluid. Use the numeric keys to do so. Press **ENTER** to confirm. The pump redisplay the first menu screen. Use the **UP** and **DOWN** keys to highlight the next parameter. **DOWN** is assumed here.



Note: The dose size must use more than 0.5 revolutions of the pumphead. To obtain best accuracy the dose size should use more than five revolutions (505CA: 1.6 revolutions). Where the dose size uses less than five revolutions (505CA: 1.6 revolutions), the pump may warn that a smaller tube size is required. If you do not change the tube size, the pump may proceed with your selected dose size but accuracy may be reduced. If the dose is smaller than the 0.5 revolution minimum (505CA: 1.6 revolutions), the pump displays a warning and does not allow you to proceed. Both warning screens are displayed for four seconds, unless cancelled by any keypress. If you wish to proceed with the dose size, you must perform a new pump calibration using a smaller tube size. (See 17 Calibrate).

Dose interval

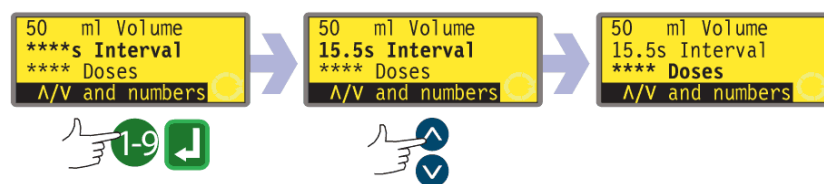

- Use the **UP** and **DOWN** keys to highlight the dose **Interval** line of the display (the second line, first screen). The display shows the previously set time interval between doses in seconds.
- If the interval displayed is correct, do nothing. **UP** and **DOWN** highlight the next or previous parameter.
- If you wish to change the interval between doses, use the numeric keys to enter the required interval, from 0 seconds to 999 seconds. Example figures are shown here. To quickly return to the starting value, press **SHIFT, 5 (CLEAR)**. Press **ENTER** to confirm. If you wish to change other parameters, use the **UP** and **DOWN** keys to highlight each as required. **DOWN** is assumed here.

Note:

Interval = 0 : Discrete doses each triggered by pressing START, in batch or not

Interval > 0 : Completes batch automatically if doses > 1. Press START to begin

Number of doses

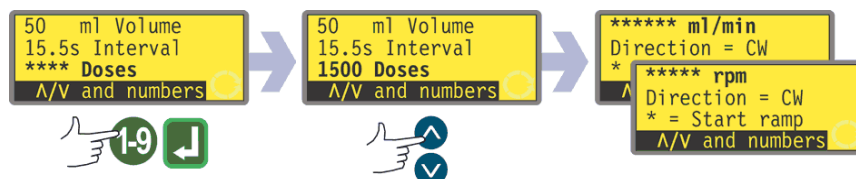

- Use the **UP** and **DOWN** keys to highlight the **Doses** line of the display (the third line, first screen). The display shows the previously set number of doses.
- If the number displayed is correct, do nothing. **UP** and **DOWN** highlight the next or previous parameter.
- If you wish to change the number of doses, use the numeric keys to enter the required number, from 1 to 9999. Example figures are shown here. To quickly return to the starting value, press **SHIFT, 5 (CLEAR)**. Press **ENTER** to confirm. If zero is entered, a warning screen is displayed briefly and the opportunity to choose a dose number is repeated. If you wish to change other parameters, use the **UP** and **DOWN** keys to highlight each as required. **DOWN** is assumed here.

Note:

Doses = 1 : No batch. The display counts up. Press START for each dose

Doses > 1 : Batch. The display counts down. Press START to begin batch

Pump speed or flowrate

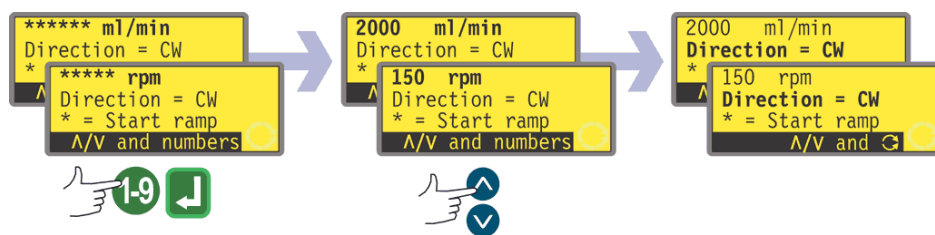

- Use the **UP** and **DOWN** keys to highlight the speed line of the display (the first line, second screen). The display shows the previously set pump speed OR the previously set flowrate. Flowrate is displayed if you chose **Flowrate** as the preferred units for dosing flow as part of the Setup sequence. See 19 *Setup*.
- If the speed or flowrate displayed is correct, do nothing. **UP** and **DOWN** highlight the next or previous parameter.
- If you wish to change the speed or flowrate, use the numeric keys to enter the required speed or flowrate. If the value selected for speed or flowrate is outside the band allowed by the information entered when the pump was calibrated, a warning is shown and you are invited to enter a new value. Alternatively, you may need to recalibrate or choose a new tube size. Example figures are shown here. To quickly return to the starting value, press **SHIFT, 5 (CLEAR)**. Press **ENTER** to confirm. If you wish to change other parameters, use the **UP** and **DOWN** keys to highlight each as required. **DOWN** is assumed here.

Pump direction

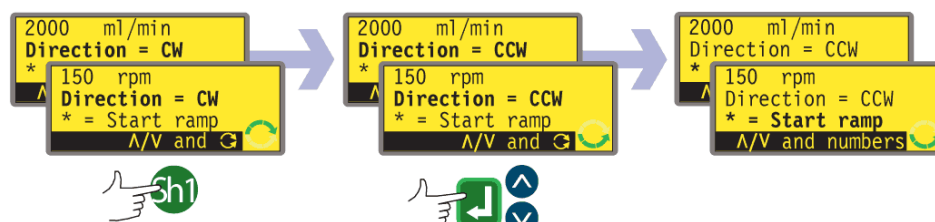

- Use the **UP** and **DOWN** keys to highlight the **Direction** line of the display (the second line, second screen). The display shows the previously set direction of rotation.
- If the direction displayed is correct, do nothing. **UP** and **DOWN** highlight the next or previous parameter.
- If you wish to change the direction, press **SHIFT, 1 (DIRECTION)** to toggle the displayed direction. An example is shown here.
Note: The direction icon at the lower right corner of the display screen also changes.
- If you wish to change other parameters, use the **UP** and **DOWN** keys to highlight each as required. **DOWN** is assumed here.

Alternatively ...

Press **SHIFT, 1 (DIRECTION)** at any point in the menu sequence.

Start ramp

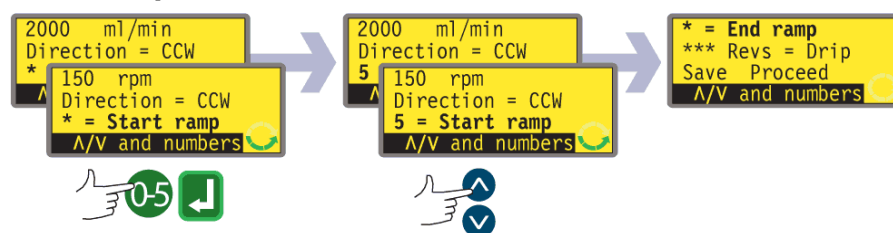

- Use the **UP** and **DOWN** keys to highlight the **Start ramp** line of the display (the third line, second screen). The display shows the start ramp setting of the last dosing session. When set to 0 the pump starts abruptly at full speed. When set to 5 the pump accelerates softly to full speed.
- If the setting displayed is correct, do nothing. **UP** and **DOWN** highlight the next or previous parameter.
- If you wish to change the setting, use the numeric keys to enter the desired setting: **0, 1, 2, 3, 4** or **5**. An example is shown here. To quickly return to the starting value, press **SHIFT, 5 (CLEAR)**. If a number greater than 5 is entered, 5 is displayed and entered. Press **ENTER** to confirm. If you wish to change other parameters, use the **UP** and **DOWN** keys to highlight each as required. **DOWN** is assumed here.

End ramp

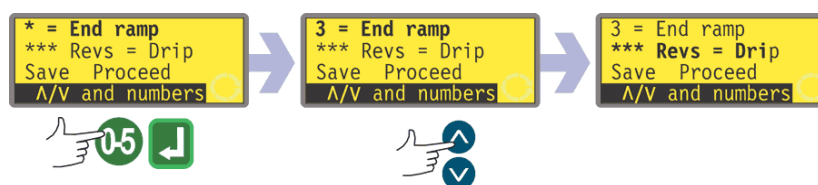

- Use the **UP** and **DOWN** keys to highlight the **End ramp** line of the display (the first line, third screen). The display shows the end ramp setting of the last dosing session. When set to '0' the pump stops abruptly. When set to '5' the pump decelerates softly to a stop.
- If the setting displayed is correct, do nothing. **UP** and **DOWN** highlight the next or previous parameter.
- If you wish to change the setting, use the numeric keys to enter the desired setting: **0, 1, 2, 3, 4** or **5**. An example is shown here. To quickly return to the starting value, press **SHIFT, 5 (CLEAR)**. If a number greater than 5 is entered, 5 is displayed and entered. Press **ENTER** to confirm. If you wish to change other parameters, use the **UP** and **DOWN** keys to highlight each as required. **DOWN** is assumed here.

Drip

The pump can be set to reverse briefly at the end of each dose to prevent drips.

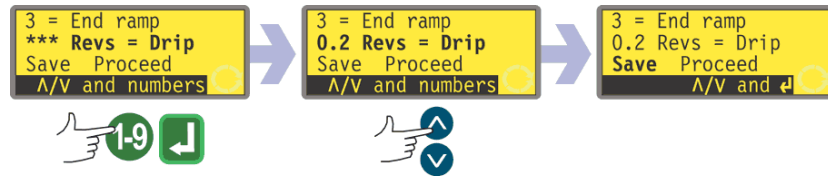

- Use the **UP** and **DOWN** keys to highlight the **Drip** line of the display (the second line, third screen). The display shows the drip setting of the last dosing session: from 0 to 1.0 (zero to one revolution) at one-tenth of a revolution intervals.
- If the setting displayed is correct, do nothing. **UP** and **DOWN** highlight the next or previous parameter.
- If you wish to change the setting, use the numeric keys to enter the desired setting: zero revolutions to 1 revolution at 0.1 revolution intervals. An example is shown here. To quickly return to the starting value, press **SHIFT, 5 (CLEAR)**. If a number greater than 1.0 is entered, 1.0 is displayed and entered. Press **ENTER** to confirm. If you wish to change other parameters, use the **UP** and **DOWN** keys to highlight each as required. **DOWN** is assumed here.

Note: The time taken by drip reversal is added to any dose interval time which may have been set.

Save and Proceed

The pump can operate immediately according to the parameters just entered; or you can save those settings by name as a dispense program for use now or later.

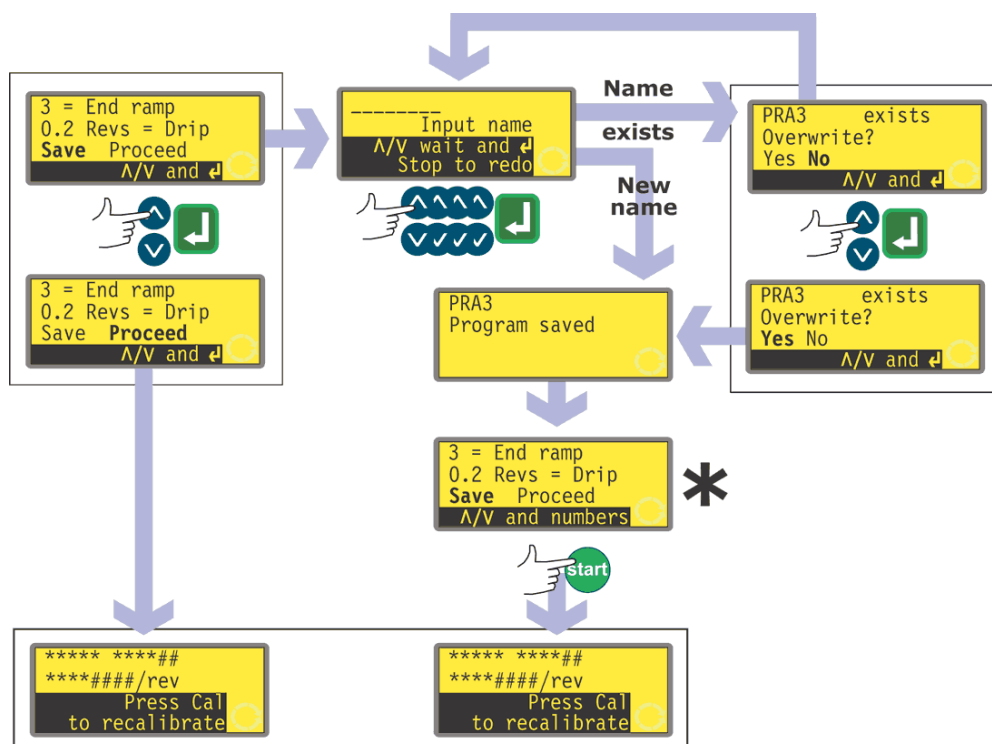

*** Note:** It is not necessary to cycle through all the dispense program settings before saving the new program or starting to dispense. You can jump straight to **Save** or **Proceed** at any point in the dispense program setting sequence; or you can press **START** at any point in the dispense program setting sequence.

- Use the **UP** and **DOWN** keys to highlight **Proceed** or **Save** (the third line, third screen).
- If you want the pump to operate without saving the parameters you have just set, press **START** or highlight **Proceed** and press **ENTER** to confirm. The pump briefly displays its pumphead, tube bore and flowrate settings. Even if you do not save the settings (and as long as you use no other saved settings), these values will be available the next time you use Dose mode.

- If you want to save the parameters you have just set, highlight **Save**. Press **ENTER** to confirm. The pump invites you to enter a name of up to eight characters for the new dispense program. An example name and settings are shown here.
- The name may include the letters A-Z, 'space' and the figures 0-9, entered one character at a time. Use the **UP** and **DOWN** keys to scroll the available characters. When the name entry screen first appears, a cursor highlights the space for the first character. Pressing **UP** causes the letter A to appear; pressing **UP** again within one second causes the letter B to appear... Pressing **DOWN** causes the figure 9 to appear; pressing **DOWN** again within one second causes the figure 8 to appear...
- After a delay of 1 second, the current character is accepted and the cursor moves on to the second space. Repeat to select the second character. If a 'space' is required at any point in the name, use the **UP** and **DOWN** keys to scroll to it: 'space' is located between 9 and A.
- At any time in entering the program name you may press **STOP** to delete the last character entered and replace it with another character. If **STOP** is pressed repeatedly, any number of characters or the entire name may be removed.
- When the program name is complete - any number of characters up to eight - press **ENTER** to save the program with that name.
- If the name is accepted, the pump briefly displays a confirmation screen with the message **Program saved**.
- If the name duplicates the name of a dispense program previously saved, the pump asks if the user wishes to overwrite the existing program with the new program. Use the **UP** and **DOWN** keys to highlight **Yes** or **No** and press **ENTER** to confirm. If **No** was selected, the pump invites the user to enter a new name; if **Yes** was selected, the pump briefly displays a confirmation screen with the message **Program saved**.
- The pump redisplay the third screen of the dispense program setting sequence. If the user wishes to run the new program, he may select **Proceed** as above or press **START**. The pump briefly displays its pumphead, tube bore and flowrate settings.

16.2 Loading a stored dispense program

If the user selected **Load program** from the Dose options displayed after selecting **Dose** on the Main menu screen, the Find program screen is displayed.

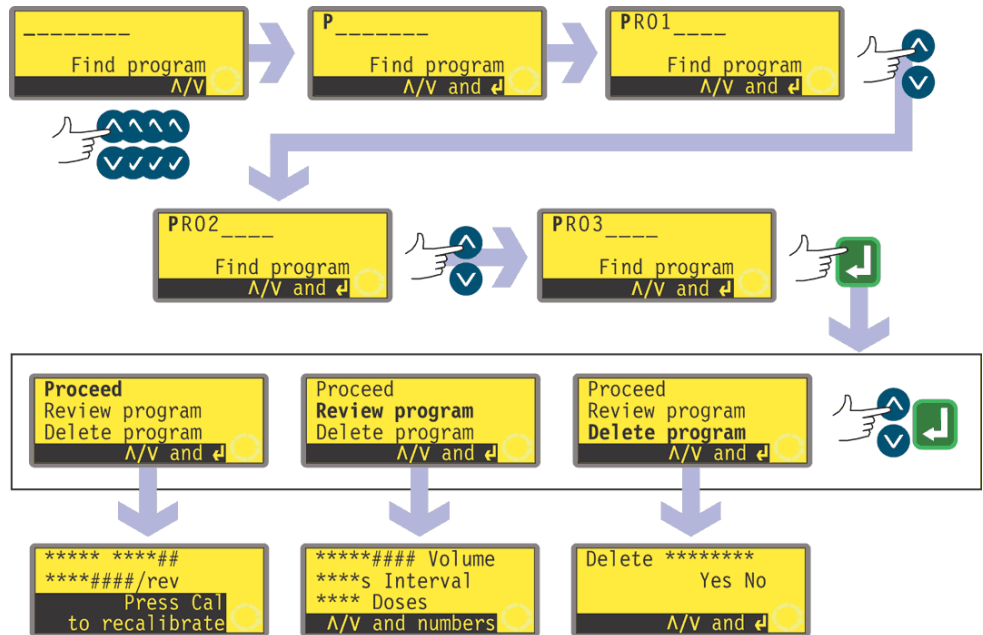

- Use the **UP** and **DOWN** keys to highlight the first character of the dosing program you wish to load. Pressing **UP** causes the letter A to appear; pressing **UP** again within one second causes the letter B to appear... Pressing **DOWN** causes the figure 9 to appear; pressing **DOWN** again within one second causes the figure 8 to appear..
- After a delay of 1 second, the pump displays the full name of its first stored program beginning with the displayed character.
- Use the **UP** and **DOWN** keys to display the full names of all stored programs. Examples are shown here.
- When the required program name is displayed, press **ENTER** to confirm.
- The pump offers three choices: **Proceed**, **Review program** and **Delete program**. Use the **UP** and **DOWN** keys to highlight an option and press **ENTER** to confirm.
- If **Proceed** was chosen, the pump runs the selected program. See 16.3 *Starting a dispense program*.
- If **Review program** was chosen, the pump displays the first screen of the Dispense program parameters menu. See 16.1 *Setting a dispense program*.
- If **Delete program** was chosen, the pump asks for confirmation. Use the **UP** and **DOWN** keys to highlight **Yes** to delete the program; highlight **No** to retain the program and return to the previous screen.

Note: If the security code is set, the user must correctly enter the security code before the pump will delete the program. See 15 *Security code entry*.

16.3 Starting a dispense program

DiN

After a dispense program has been set or loaded, it may be started.

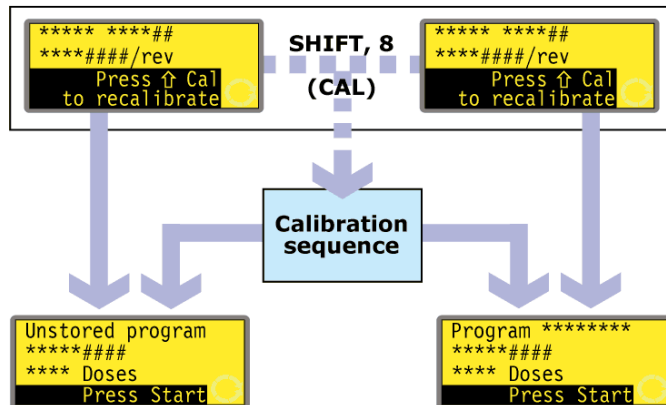

- If **SHIFT, 8 (CAL)** is pressed, the pump allows the user to run the calibration sequence. See 17 *Calibrate*.
- When calibration is complete or if it was not selected, the pump summarises the program it is ready to run and invites the user to press **START** or apply a remote signal (see 20.5 *Dose input*) to start it.

Di

When a dispense program has been set or loaded, it may be started. An invitation to recalibrate the pump is displayed for 3 seconds, before a summary of the program appears.

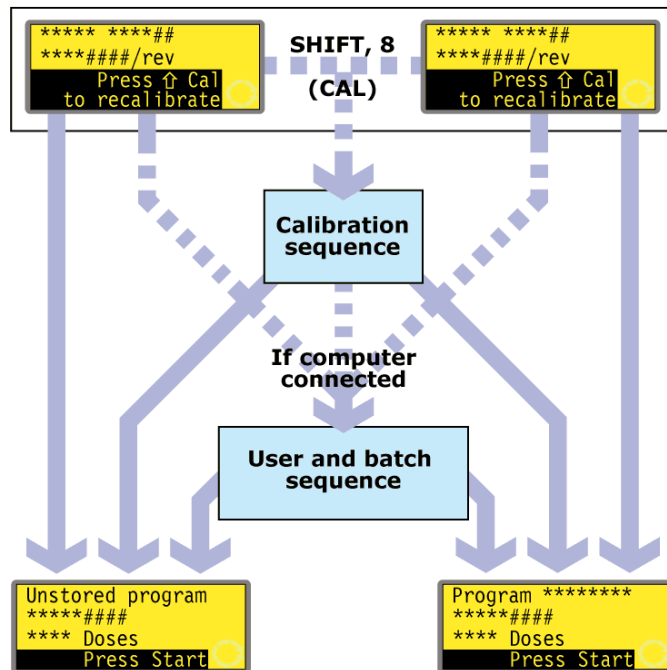

- If **SHIFT, 8 (CAL)** is pressed, the pump allows the user to run the calibration sequence. See 17 *Calibrate*.
- When calibration is complete or if it was not selected, the pump checks whether a computer is connected to the pump. If so, the pump allows the user to enter information about the pump operator and the dispense batch. See 16.4 *User and batch sequence*.
- When user and batch information has been entered, or if no computer is connected to the pump, the pump summarises the program it is ready to run and invites the user to press **START** or apply a remote signal (see 20.3 *Dose input*) to start it.

16.4 User and batch sequence

If a computer is connected to the pump, the pump records two pieces of information about the current batch.

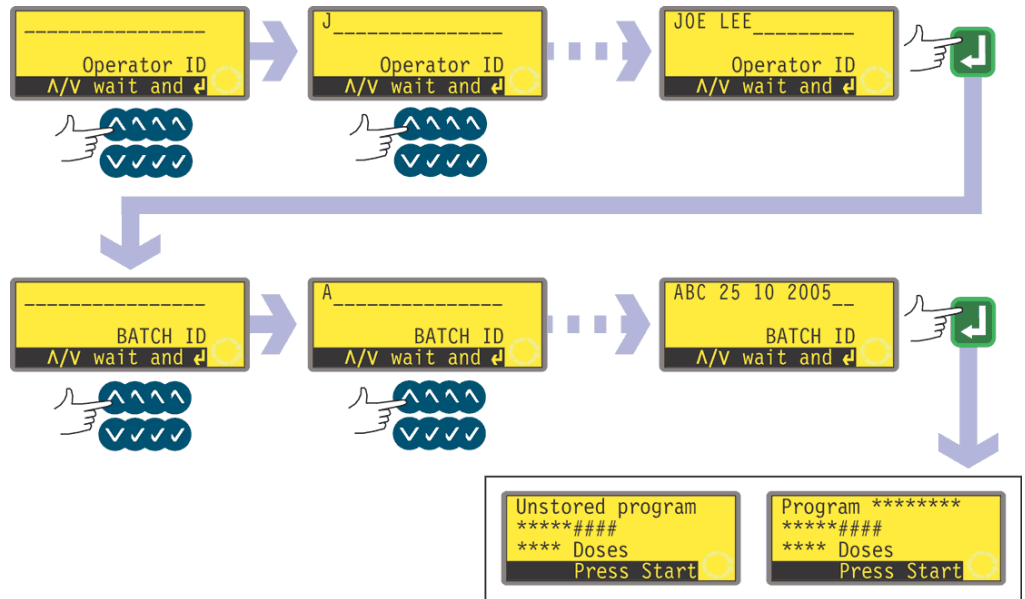

- The pump asks for the name of the operator. Up to 16 characters may be entered.
- Use the **UP** and **DOWN** keys to highlight the first character of the operator's name. Pressing **UP** causes the letter A to appear; pressing **UP** again within one second causes the letter B to appear... Pressing **DOWN** causes the figure 9 to appear; pressing **DOWN** again within one second causes the figure 8 to appear...
- After a delay of 1 second, the current character is accepted and the cursor moves on to the second space. Repeat to select the second character. If a 'space' is required at any point in the name, use the **UP** and **DOWN** keys to scroll to it: 'space' is located between 9 and A.
- When the name is complete, press **ENTER** to confirm. The operator's name is saved. The information entered will be output when the batch is run.
- The pump asks for the name of the batch. Up to 16 characters may be entered.
- Use the **UP** and **DOWN** keys to highlight the first character of the batch name. Pressing **UP** causes the letter A to appear; pressing **UP** again within one second causes the letter B to appear... Pressing **DOWN** causes the figure 9 to appear; pressing **DOWN** again within one second causes the figure 8 to appear...
- After a delay of 1 second, the current character is accepted and the cursor moves on to the second space. Repeat to select the second character. If a 'space' is required at any point in the name, use the **UP** and **DOWN** keys to scroll to it: 'space' is located between 9 and A.
- When the name is complete, press **ENTER** to confirm. The batch name is saved. The information entered will be output when the batch is run.
- The pump summarises the program it is ready to run and invites the user to press **START** to run it.

16.5 While a dispense program is running

A dispense program may call for the pump to dispense:

- a batch containing a known number of single doses, each dosed on demand by a trigger such as a press on **START** or a footswitch, or a plc signal (note that at the end of such a batch the options available are to return to the main menu or to repeat the batch by pressing **START**);
- a batch of a known number of doses with a pre-set time interval between doses, started by a trigger as above;
- an unknown number of doses to be dosed singly on demand by a trigger as above.

The first two options are governed by the Dose interval setting in the dispense program. See 16.1 *Setting a dispense program*. If the interval is set to zero, the pump dispenses doses singly. If the interval is set to any other figure, the batch will be dispensed.

The third option is governed by the Number of doses setting in the dispense program. See 16.1 *Setting a dispense program*.

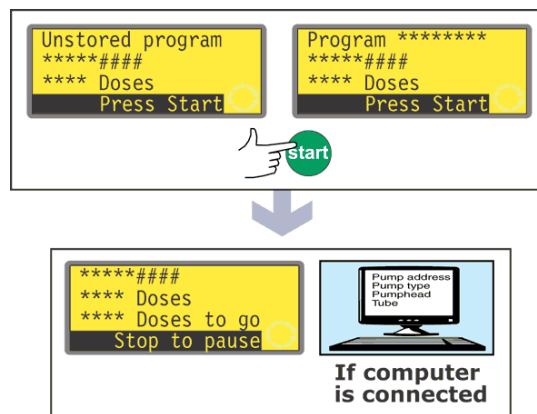

- Press **START**.
- The pump starts dispensing the first dose of the batch, and displays its progress: dose size; how many doses in the batch are still to be dispensed; how many doses in the batch have been dispensed.

- If a computer is connected to the pump (520Di only), all the current program parameters are output, plus the current date and time. An example is shown here:

```
Pump address 16
Pump type 525Di
Pumphead 520R
Tube 6.4 mm
Program name PROG1
Flow calibration 6.780 ml/rev
Dose size 123.4 ml
Interval 10 s
Number of doses 9999
Speed 100.5 rpm
Direction CCW
Start ramp 0
End ramp 1
Drip 1

Operator ID Joe Lee
Batch ID ABC 25 10 2005
Date 25.10.05
Time 16:42:00
Program started
```

A batch of single doses

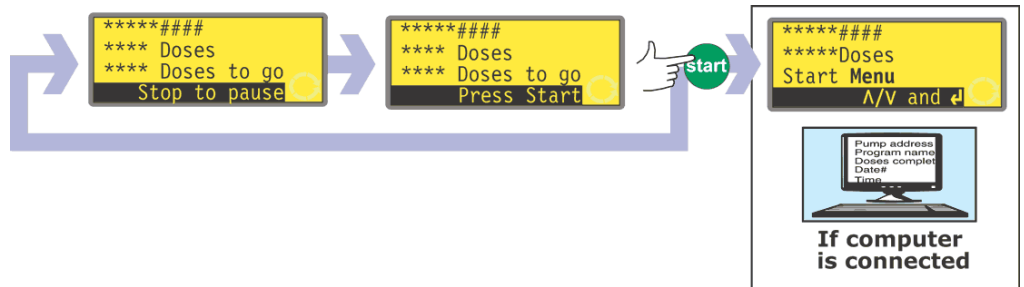

- If the batch was set to be dispensed with an interval between doses of zero seconds, the pump stops after dispensing the first dose of the batch and waits for a further press on **START**.
- When **START** is pressed it starts dispensing the next dose of the batch, and displays its progress: dose size; how many doses in the batch have been dispensed; how many doses in the batch are still to be dispensed.
- This cycle is repeated until the batch is complete. The pump summarises the batch just completed.
- Use the **UP** and **DOWN** keys to select **Menu** to return to the Main menu and press **ENTER** to confirm.
- Use the **UP** and **DOWN** keys to select **Start** to run the batch again, and press **ENTER** to confirm.

Alternatively...

Press **START** to run the batch again.

- If a computer is connected to the pump (520Di only), a log message is output. An example is shown here:

```
Pump address 16
Program name PROG1
Doses completed 9999
Date 25.10.05
Time 16:42:00
Batch completed
```

The batch can be paused or stopped at any time.

- Press **STOP** or apply a remote pause-dose signal, while the batch is being dispensed to pause or stop the batch. See 16.6 *To stop or pause a dispense program*.

A batch of timed doses

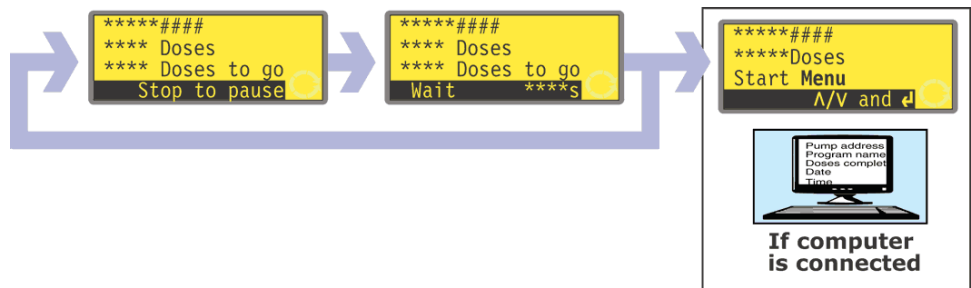

- If the batch was set to be dispensed with an interval between doses greater than zero seconds, the pump stops after dispensing the first dose of the batch and waits for the interval to pass.
- When the interval has passed it starts dispensing the next dose of the batch, and displays its progress: dose size; how many doses in the batch have been dispensed; how many doses in the batch are still to be dispensed.
- This cycle is repeated until the batch is complete. The pump summarises the batch just completed. Use the **UP** and **DOWN** keys to select **Menu** to return to the Main menu and press **ENTER** to confirm. Use the **UP** and **DOWN** keys to select **Start** to run the batch again, and press **ENTER** to confirm.

Alternatively...

Press **START** to run the batch again.

- If a computer is connected to the pump (520Di only), a log message is output. An example is shown here:

```
Pump address 16
Program name PROG1
Doses completed 9999
Date 25.10.05
Time 16:42:00
Batch completed
```

The batch can be paused or stopped at any time.

- Press **STOP** or apply a remote pause-dose signal, while the batch is being dispensed to pause or stop the batch. See 16.6 *To stop or pause a dispense program*.

An unknown number of single doses



- If the batch was set to contain 1 dose, the pump starts dispensing the dose, and displays its progress: dose size; and how many doses have been dispensed. It stops after dispensing that dose and waits for a further press on **START**.
- Press **START** to run the batch again.

The cycle can be paused or stopped at any time.

- To pause a dose, press **STOP** or apply a remote pause-dose signal while a dose is being dispensed. See 16.6 *To stop or pause a dispense program*.
- To stop the cycle, press **STOP**, or apply a remote pause-dose signal, after a dose has been dispensed. See 16.6 *To stop or pause a dispense program*.

16.6 To stop or pause a dispense program

A batch can be stopped or paused by pressing **STOP**, or applying a remote pause-dose signal, while the batch is being dispensed. See 19.11 *Remote stop*.

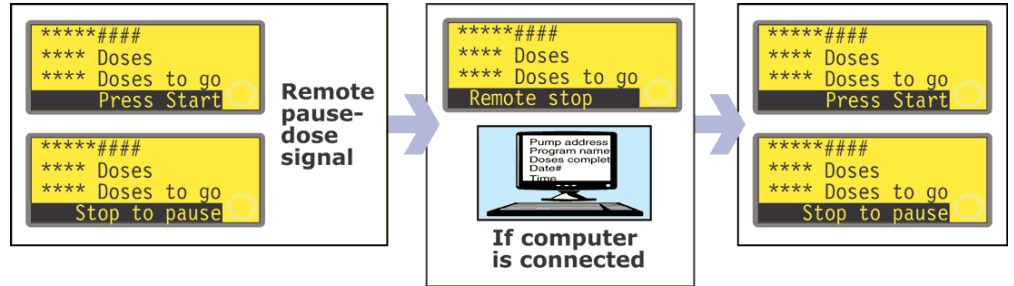

- If the batch was paused by applying a remote pause-dose signal, the pump stops and displays its progress; when the remote pause-dose signal is no longer applied, the pump continues from where it left off, completing any interrupted dose.

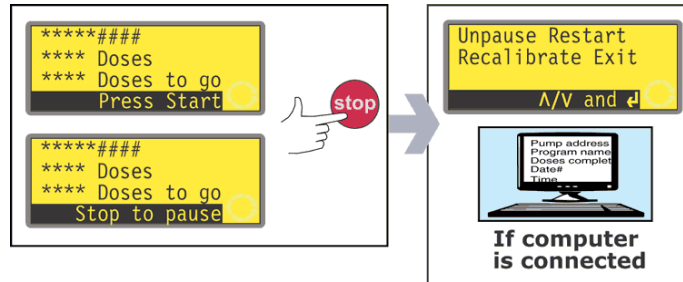

- If the batch was paused by pressing **STOP**, the pump stops and offers four choices: **Unpause**, **Restart**, **Recalibrate** and **Exit**.
- In either case (pause or stop), if a computer is connected to the pump (520Di only), a status message is output. An example is shown here:

```
Pump address 16
Program name PROG1
Doses completed 520
Doses to go 9479
Date 25.10.05
Time 16:52:00
Batch paused
```

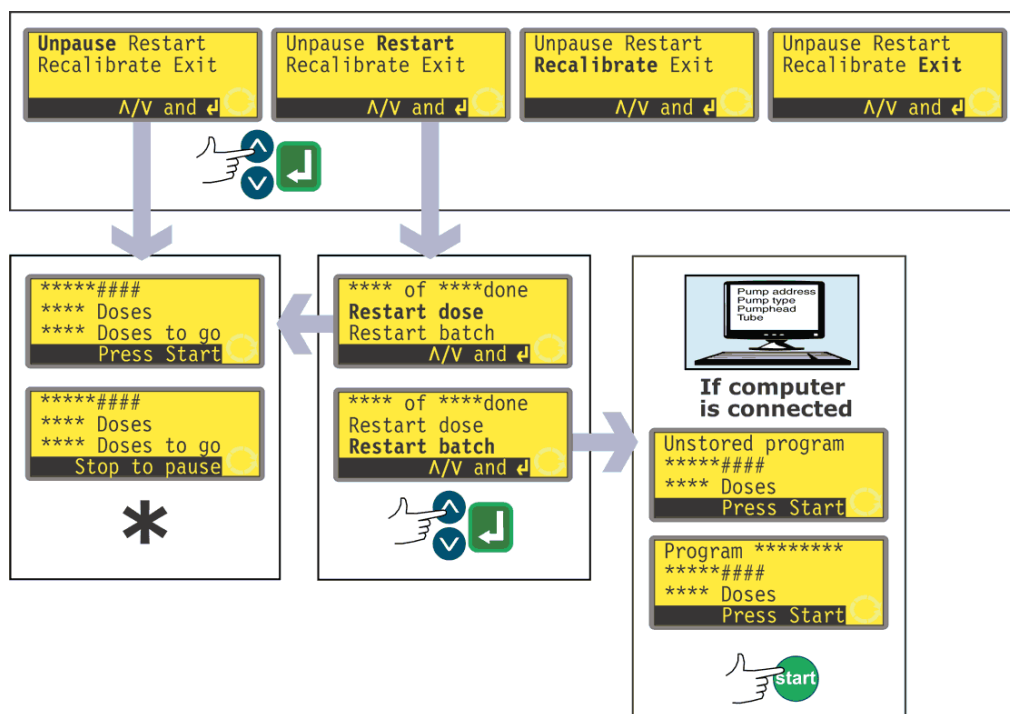

* **Note:** If dispensing is resumed after a remote pause-dose signal or by selecting **Unpause**, any interrupted dose is continued. If dispensing is resumed by selecting **Restart**, any interrupted dose is aborted and repeated from its start.

- Use the **UP** and **DOWN** keys to make a selection and press **ENTER** to confirm.
- If **Unpause** is selected, dispensing is resumed where it left off. Any interrupted dose is completed.
- If **Restart** is selected, the pump offers to restart any interrupted dose or to restart the interrupted batch. Use the **UP** and **DOWN** keys to highlight **Restart dose** or **Restart batch** and press **ENTER** to confirm.
- If **Restart dose** is selected, dispensing is resumed where it left off. Any interrupted dose is aborted and repeated from its start.
- If **Restart batch** is selected, the interrupted batch is aborted and the pump waits for **START** to be pressed to begin the batch again.
- If a computer is connected to the pump (520Di only), a status message is output. An example is shown here:

```
Pump address 16
Program name PROG1
Doses completed 521
Date 25.10.05
Time 16:59:00
Batch aborted
```

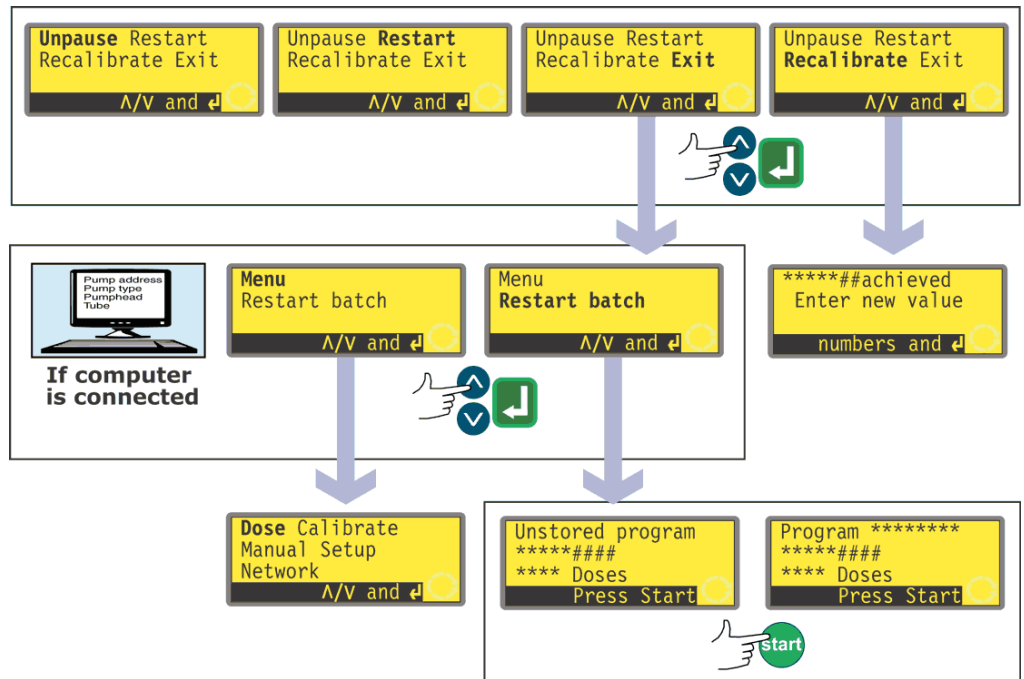

- Use the **UP** and **DOWN** keys to make a selection and press **ENTER** to confirm.
- If **Exit** is selected, the pump offers to restart the interrupted batch or to display the Main menu. In either case the previous batch is aborted. Use the **UP** and **DOWN** keys to highlight **Menu** or **Restart batch** and press **ENTER** to confirm.
- If a computer or printer is connected to the pump (520Di only), a status message is output. An example is shown here:

```
Pump address 16
Program name PROG1
Doses completed 521
Date 25.10.05
Time 16:59:00
Batch aborted
```

- If **Menu** is selected, the pump displays the Main menu.
- If **Restart batch** is selected, the batch waits for **START** to be pressed to begin the batch again.
- If **Recalibrate** is selected, the pump may be recalibrated. See 17 *Calibrate*.

Note: Recalibration can also be invoked during dosing. Press **SHIFT, 8 (CAL)** while a dose is being dispensed. The dose will continue to run while the recalibration is performed. The current dose will not be affected; the new calibration will take effect from the next dose. If **SHIFT, 8 (CAL)** is pressed when dosing is stopped, full calibration (as against recalibration) may be performed. See 17 *Calibrate*.

17 Calibrate

Calibrate and Recalibrate are different processes. **Calibrate** allows the user to set up the pump before use to correctly display flowrate in the units per revolution chosen during the Setup sequence. (See 19 *Setup*.) **Recalibrate** allows the user to adjust the pump's flowrate while it is in use; it can even be initiated while a dispense batch is running (by pressing **SHIFT, 8 (CAL)**).

Pumphead and tube sizes available

Pumphead	Tube sizes (mm)
520R, 505L	0.5 0.8 1.6 3.2 4.8 6.4 8.0 9.6
313, 314, 501RL	0.5 0.8 1.6 3.2 4.8 6.4 8.0
505CA, 314MC, 318MC	0.13 0.19 0.25 0.38 0.50 0.63 0.76 0.88 1.02 1.14 1.29 1.42 1.52 1.65 1.85 2.05 2.29 2.54 2.79

The maximum pump speed depends on the pumphead selected:

505L 313	314 520R 501RL	505CA	314MC 318MC
350	300	170	110

Note: This instruction manual includes further details on only the 520R and 505L pumpheads. If you wish to fit one of the others listed above, refer to the information accompanying it for further details.

Calibrate

To dispense the correct amount of fluid the pump must know which pumphead is fitted and the tube size in the pumphead. The pump is pre-programmed with default flow rate figures for a range of pumpheads and tubes. For the most accurate calibration, you may measure the flow from the pump and enter this value instead of the default.

Pump calibration can be limited to users who correctly enter a three-digit security code. If a security code has been set, selecting **Change** from the calibration details screen and confirming with the **ENTER** key causes the pump to display the Security code entry sequence. See 15 *PIN-secure process protection*. If no security code has been set, the pump displays the first screen of the calibration sequence.

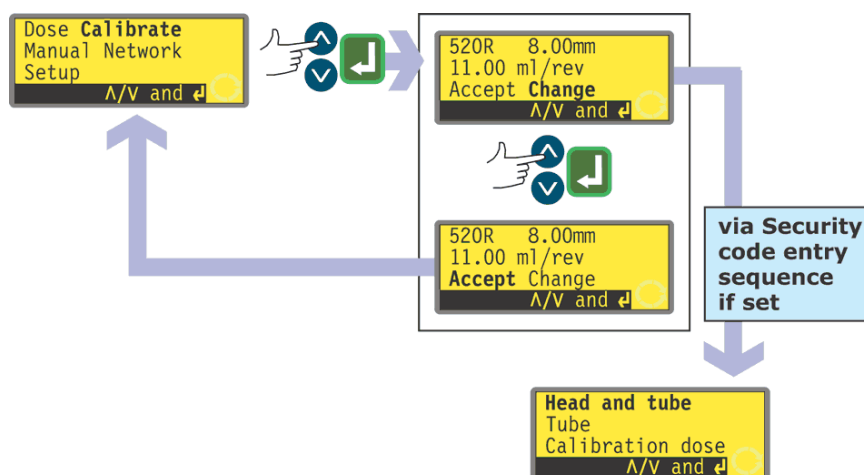

- Use the **UP** and **DOWN** keys to highlight **Calibrate** in the Main menu. Press **ENTER** to confirm.
- The pump displays its current settings: pumphead, tube size and flowrate; the default for each standard pumphead is the largest tube the pumphead can take. Example information is shown here.
- Use the **UP** and **DOWN** keys to highlight **Accept** or **Change**. Press **ENTER** to confirm.
- If **Accept** is selected, the default or previously set flowrate data for that pumphead and tube size are used in flowrate calculations. The pump redisplay the Main menu.
- If **Change** is selected with a security code in place, the pump starts its security code entry sequence. See 15 *Security code entry*. When the correct code is entered, the pump offers three options: **Head and tube**; **Tube**; and **Calibration dose**. If **Change** is selected with no security code in place, the three options are displayed immediately.
- Use the **UP** and **DOWN** keys to make a selection. Press **ENTER** to confirm.

Head and tube

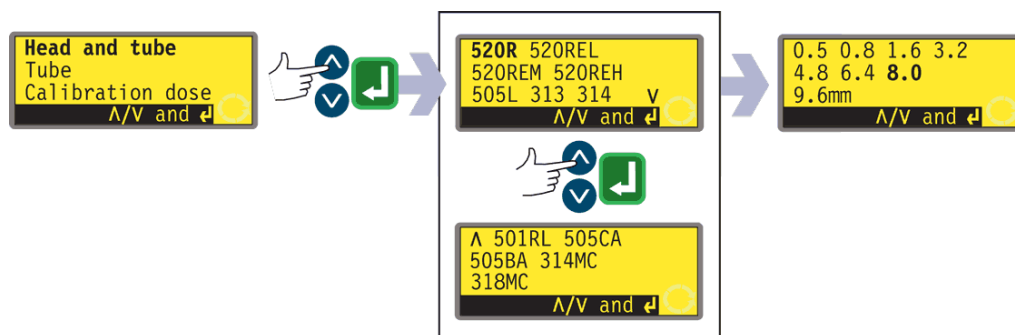

- If **Head and tube** is selected, the pump displays a list of standard pumpheads that can be fitted to the pump. It occupies two screens. Use the **UP** and **DOWN** keys to move the highlight down the list. When the last item on the first screen is highlighted, a further press on the **DOWN** key causes the pump to display the second screen with its first item highlighted.
- Use the **UP** and **DOWN** keys to make a selection. Press **ENTER** to confirm. An example is shown here.
- The pump displays tube sizes, as below.

Tube

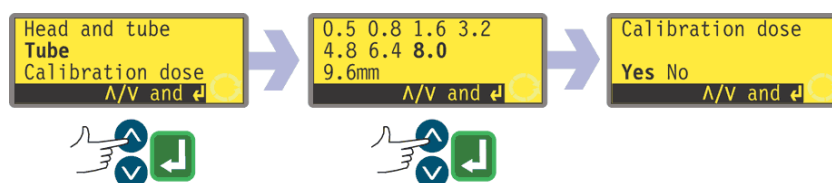

- If **Tube** is selected or a pumphead choice has just been made, the pump displays a list of standard tube sizes that can be used in the pumphead previously identified. An example is shown here.
- Use the **UP** and **DOWN** keys to make a selection. Press **ENTER** to confirm.

Calibration dose

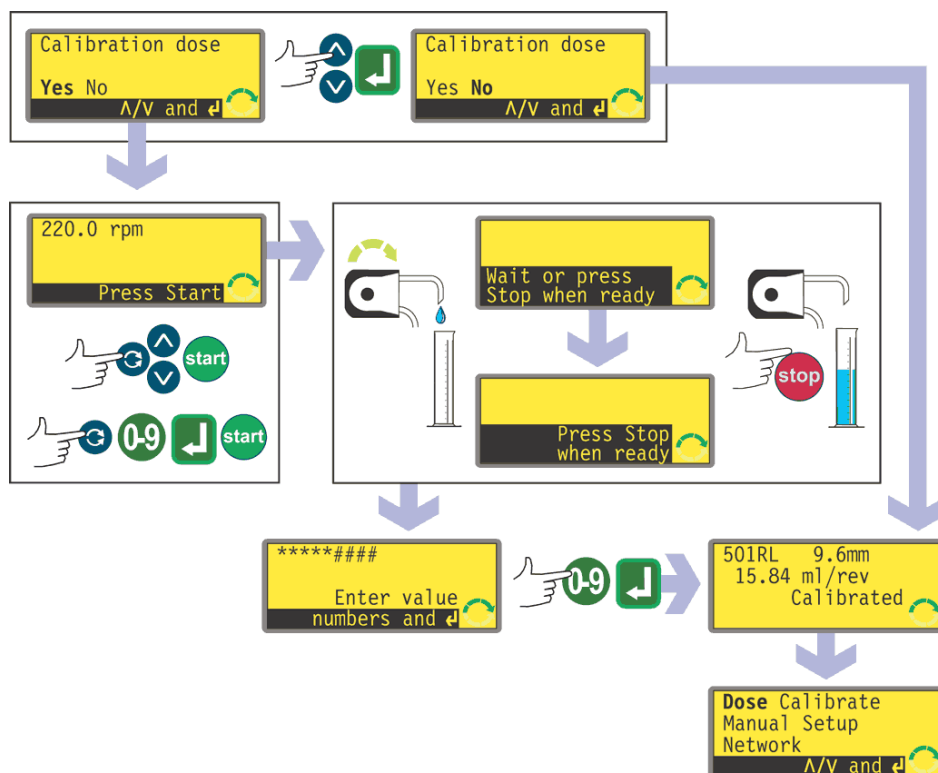

- The pump offers to run a calibration dose. Use the **UP** and **DOWN** keys to choose **Yes** or **No**. Press **ENTER** to confirm. Examples are shown here.
- If **No** is selected after a tube selection has been made (see *Tube* above), the pump briefly displays a confirmation screen showing current head, tube and flow settings, and redisplay the Main menu.
- If **Calibration dose** is selected or if **Yes** is selected after a tube selection has been made (see *Tube* above), the pump displays the speed and direction at which it was last running in manual mode or to which it has just been set and invites the user to press **START**.

Note: Full calibration can also be invoked by pressing **SHIFT, 8 (CAL)** when dosing is stopped.

Note: it is possible at this point to change the direction of rotation using the **SHIFT, 1 (DIRECTION)** key, and to change the speed of rotation using the **UP** and **DOWN** keys (or the numeric keys followed by the **ENTER** key), up to the pump's maximum speed or any (lower) maximum available speed which has previously been set. See 19.13 *Set maximum allowed speed*. If the pumphead has been changed at this point, any previously set speed will be over-ridden by any lower pumphead maximum speed. The user can reprime the pump before calibration by pressing **SHIFT, 4 (MAX)** (if **Always enabled** was selected while setting up the pump - see 19 *Setup*).

- Put a measuring container at the pump outlet. Press **START**. The pump runs for 4 minutes, displaying an information screen for 15 seconds and a further information screen for the rest of the 4 minutes. You may stop the calibration dose at any time with the **STOP** key - but allow the pump to run as long as possible to obtain the most accurate calibration. A minimum of 15 seconds is recommended.
- Measure the quantity of fluid dispensed. The pump displays its calculated dose, based on previous calibration data. Use the numeric keys to adjust this reading to match the measured volume. Press **ENTER**. The pump displays the new head, tube and flow settings, and redisplay the Main menu. Example figures are shown here.

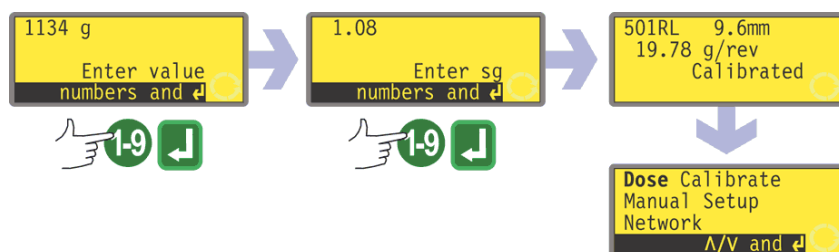

Note: If the pump has been set to display flow rate in units of mass (See 19.7 *Flow units*), as in this example, the pump displays a screen allowing you to confirm the specific gravity of the duty fluid immediately before the final press on **ENTER**.

Note: Always recalibrate after changing pump tubes, fluid, or any connecting pipework. It is also recommended that the pump is recalibrated periodically to maintain accuracy.

Note: If the pump power is cycled while flow rate is displayed, calibration is lost and a warning is displayed.

Recalibrate

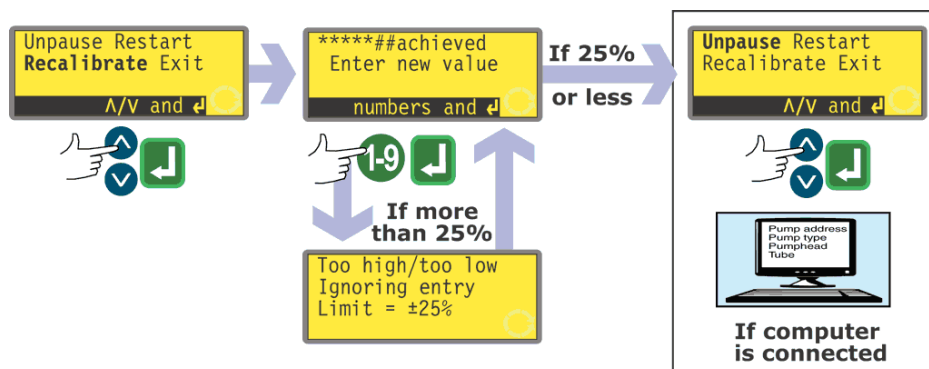

- After pressing **STOP** while the pump is running, use the **UP** and **DOWN** keys to highlight **Recalibrate** and press **ENTER** to confirm.

Alternatively...

Press **SHIFT, 8 (CAL)** while in a dispensing sequence to carry out the recalibration "on the fly".

Note: If **SHIFT, 8 (CAL)** is pressed when a dispensing sequence is not in progress or is paused, *full* calibration will be carried out.

- The pump displays the current dose size. Enter a new value using the numeric keys and press **ENTER** to confirm.
- If the dose size required is within 25% of the previous dose size, the pump accepts the new dose size and offers four choices: **Unpause, Restart, Recalibrate** and **Exit**. Use the **UP** and **DOWN** keys to make a selection and press **ENTER** to confirm. If the recalibrate sequence was entered by pressing **SHIFT, 8 (CAL)** while a dose was being dispensed, the pump redisplay the running screen and continues to dispense. The new calibration takes effect when the next full dose is started.
- If a computer is connected to the pump (520Di only), a status message is output. An example is shown here:

```

Pump address 16
Program name PROG1
Doses completed 521
Date 25.10.05
Time 16:59:00
Flow calibration 6.830 ml/rev
Recalibrated
  
```

- If the dose size required is more than 25% larger or smaller than the previous dose size, the pump briefly displays a warning message and invites the user to enter a new value.

Note: After highlighting **Recalibrate** and pressing **ENTER** to confirm, or pressing **SHIFT, 8 (CAL)** while a dose is being dispensed, the user can reprime the pump before recalibration by pressing **SHIFT, 4 (MAX)** (if **Always enabled** was selected while setting up the pump - see 19 *Setup*).

18 Manual operation



To enter manual mode, use the **UP** and **DOWN** keys to highlight **Manual** in the Main menu. Press **ENTER** to confirm. The pump displays the Manual running screen, showing the pump's default units: revolutions per minute or the flowrate to which the pump is set. The default units can be changed. See 19 *Setup*.

18.1 Keypad functions in manual mode

All settings and functions of the pump in Manual mode are set and controlled by means of key-presses. In the Manual running screen, the currently selected rotation direction is indicated on the display by a clockwise or counter-clockwise segmented arrow. If an exclamation mark (!) shows, it indicates that Auto-restart is on (see 19.12 *Auto-restart*).

Note: A number of the controls listed below are shortcuts to commands which are also available through the Main menu. See 14 *Main menu*.

A brief single press on each key triggers a beep sound (if enabled - see 19.19 *Beep*) and causes the pump to function as follows:



- **START:** starts the pump at the speed and in the direction shown on the display. The rotation symbol becomes animated to confirm that the pump is operating. We recommend that the speed is reduced to a minimum (0.1 rpm) before starting the pump.



If the pump is running when **START** is pressed, it causes the information shown on the Manual running screen to cycle from revolutions per minute, to flowrate in a choice of units (via a warning screen if flowrate has not been calibrated and if this is the first cycle since power-up) to rpm and flowrate. An example is shown here. (See 17 *Calibrate*). This cycle operates in a similar way if **ENTER** is pressed. The default can be altered from within the Setup menu. See 19.2 *Display*.

Note: If the pump has not been calibrated, the flowrate displayed assumes the default pumphead: 505L; and its default tube size: 9.6mm.

- **STOP:** has no effect if the pump is not running. If the pump is running, pressing **STOP** stops the pump. The display continues to show the previous speed and direction. The pump will return to this speed and direction when the **START** key is pressed again.
- **UP:** increases the speed shown on the display in minimum steps of 0.1 rpm (unless the speed displayed is already the maximum allowed speed). If the pump is then started by pressing the **START** key, it will operate at the new speed. If the pump is running when **UP** is pressed, the change takes effect immediately.

Note: After a speed change (if the pump has been calibrated), a screen showing the new rpm figure **and** the new flowrate is displayed for four seconds before returning the user to the previously set Manual running screen: rpm **or** flowrate.

- **DOWN**: decreases the speed shown on the display in minimum steps of 0.1 rpm. If the pump is then started by pressing the **START** key, it operates at the new speed. The minimum speed possible is 0.1 rpm. If the pump is running when **DOWN** is pressed, the change takes effect immediately.
Note: After a speed change (if the pump has been calibrated), a screen showing the new rpm figure **and** the new flowrate is displayed for four seconds before returning the user to the previously set Manual running screen: rpm **or** flowrate.
Note: You can reduce the pump speed from 0.1 rpm to 0 rpm by a further press on the **DOWN** key. The pump is still in the running state and the rotation symbol continues to move. Press the **UP** key to return the pump to the minimum speed.
- **ENTER**: cycles the information shown on the Manual running screen from revolutions per minute, to flowrate in a choice of units (via a warning screen if flowrate has not been calibrated and if this is the first cycle since power-up) to rpm and flowrate. (See **START**, above. See 17 *Calibrate*.) This cycle operates when the pump is stopped and when it is running. The default can be altered from within the Setup menu. See 19.2 *Display*. **ENTER** must be pressed to confirm a new speed entered by pressing numeric keys.
- **0, 1, 2, 3, 4, 5, 6, 7, 8, 9**: numeric keys are used to enter a new speed or, if the pump is displaying only its flowrate, a new flowrate.
- **SHIFT**: Pressing the **SHIFT** key displays an arrow symbol in the lower left corner of the screen, indicating that the next keypress will be in Shift mode. Pressing the **SHIFT** key, then pressing **0, 1, 4, 5, 6, 7, 8, 9, UP** or **DOWN** invokes the action indicated in yellow on those keys, and then cancels Shift mode. If the **SHIFT** key is pressed in error, Shift mode may be cancelled by a second press on the **SHIFT** key.
 - SHIFT, 0 (.)**
enters a decimal point in a numeric expression. The number "10.55", for example, is entered by pressing **1, 0, SHIFT, 0, 5, 5**.
 - SHIFT, 1 (DIRECTION)**
toggles the direction of rotation shown on the display. If the pump is then started by pressing the **START** key, it rotates in the new direction. If the pump is running when **SHIFT, 1 (DIRECTION)** is pressed, the change takes effect immediately.
 - SHIFT, 4 (MAX)**
operates the pump at the maximum allowed speed and in the direction shown on the display. When released, the pump returns to its previous status. Priming can be achieved by pressing **SHIFT, 4 (MAX)** until fluid flows through the pump and reaches the point of discharge, and then releasing **SHIFT, 4 (MAX)**.

SHIFT, 5 (CLEAR)

during numeric entry, clears the current value or restores it to its value on entry to that screen, allowing numeric entry to continue.

SHIFT, 6 (LOAD)

jumps out of Manual mode and into Dose mode, ready to allow the recall of a dispense program stored in NVRAM. It has no effect if no program has been stored. See 16 *Dose*.

SHIFT, 7 (MENU)

displays the Main menu, from which all aspects of pump setup can be controlled. See 14 *Main menu*.

SHIFT, 8 (CAL)

invokes calibration. See 17 *Calibrate*.

SHIFT, 9 (INFO)

causes the pump to display the volume of fluid it has dispensed since being set to zero or recalibrated. The information screen is displayed only while **SHIFT, 9 (INFO)** is pressed and held. If **STOP** is pressed while the information screen is displayed, the volume dispensed figure is reset to zero.

SHIFT, UP

sets the pump to maximum allowed speed.

SHIFT, DOWN

sets the pump to minimum speed: 0.1 rpm.

Keypress combinations cause the pump to function as follows:

- **UP** and **1 (DIRECTION)** on power-up: toggles the keypad beep on and off.
- **START** on power-up: switches on the Auto-restart facility. See 19.12 *Auto-restart*.
- **STOP** on power-up: switches off the Auto-restart facility. See 19.12 *Auto-restart*.
- **STOP** and **1 (DIRECTION)** on power-up: allows the user to press **UP** and **DOWN** keys to toggle the sense of remote run / stop control between open=stop and open=run.
- **STOP** and **UP** while the pump is stopped: turns the display backlight on.
- **STOP** and **DOWN** while the pump is stopped: turns the display backlight off.
- **DOWN** and **1 (DIRECTION)**: interrupts the display to show the pump's ROM version for four seconds.

18.2 Keypad beep

The pump keypad can operate silently or indicate a positive key-press with a beep sound.

- To toggle the sound on and off, stop the pump. Turn off the mains power switch at the rear of the pump.
- Press the **UP** and **1** keys while switching on the mains power switch at the rear of the pump.

18.3 Changing pump speed during manual operation

Using the **UP** and **DOWN** keys

Pump speed can be changed between 0.1 rpm and maximum allowed speed by scrolling up and down using the **UP** or **DOWN** keys. The minimum step is 0.1 rpm.

If the default display is flowrate, flowrate can be changed in the same way; the minimum step is equivalent to 0.1 rpm.

Speed or flowrate adjustment can be done when the pump is running, in which case the change occurs immediately, or when it is stopped.

Note: You can reduce the pump speed from 0.1 rpm to 0 rpm or the flowrate from its minimum (depending on tube bore) to zero by a further press on the **DOWN** key. The pump is still in the running state and the rotation symbol continues to move. Press the **UP** key to return the pump to the minimum speed or flowrate, or, if the pump is in the running state, to cause the pump to start at minimum speed or flowrate and then increase its speed until it reaches the maximum allowed speed (or its equivalent flowrate) or until the **UP** key is released.

Using the numeric keys

Pump speed can be changed between 0.1 rpm and maximum allowed speed by entering a new speed using the numeric keys and confirming by pressing **ENTER**.

If the default display is flowrate, flowrate can be changed in the same way; the new flowrate is rounded down to that provided by the nearest lower speed setting in steps of 0.1 rpm.

Speed or flowrate adjustment can be done when the pump is running, in which case the change occurs immediately, or when it is stopped. When the first digit is entered, the screen changes to inverse video. When **ENTER** is pressed to confirm the new speed or flowrate, normal video is restored and the change takes place.

Note: If a speed entered (or implied by a required flowrate) is greater than the maximum allowed speed, the speed or flowrate and the display are capped to the maximum allowed speed or its equivalent flowrate.

Di, DiN

18.4 Manual operation and remote digital inputs and outputs

The remote run / stop, direction and leak-detected inputs are operational.

The remote status outputs are all fully functional.

The **STOP** key acts as an overriding emergency stop. The remote run / stop input will not start the pump in manual mode, but once the **START** key has been pressed, the remote run / stop input will stop and start the pump according to its operational state.

If you invert the operation of the remote run / stop switch to operate as open=stop, you must connect pin 7 to 19, lower D-connector, to be able to start the pump from the keypad.

If **STOP** is pressed the remote run / stop switch will have no effect.

You cannot invert the remote direction signal.

19 Setup

Entry to the Setup menu can be limited to users who correctly enter a three-digit security code. If a security code has been set, selecting **Setup** and confirming with the **ENTER** key causes the pump to display the Security code entry sequence. See 15 *Security code entry*. If no security code has been set, the pump displays the first of five screens containing the Setup menu.

The Setup menu

The Setup menu occupies five screens. The first two are shown here.

To move from one screen to subsequent screens, repeatedly press **DOWN**. Each item is highlighted in turn until the last item on the screen is highlighted.

A further press on the **DOWN** key displays the next screen of the menu, with the first item highlighted.

Follow the reverse procedure using the **UP** key to move to an item on a previous screen of the menu.

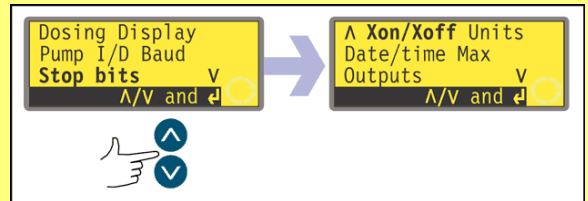

Make a selection using the **UP** or **DOWN** keys and press **ENTER** to confirm your choice.

19.1 Dosing

Items in Dosing sub-menus allow the user to set features of dosing performance.

Dosing flow units

The user can choose revolutions per minute or flowrate as flow units for dosing (as distinct from flow units for manual pumping).

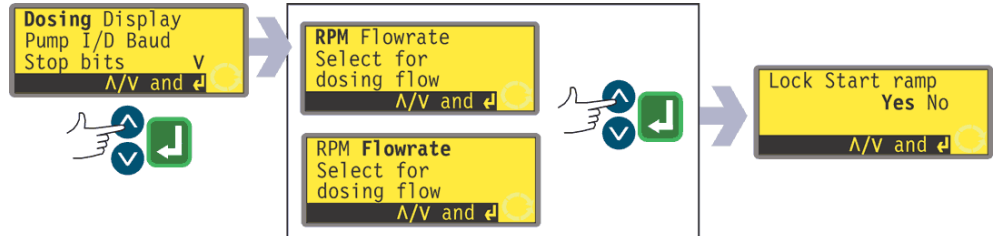

- Use the **UP** and **DOWN** keys to select **Dosing** from the first screen of the Setup menu. Press **ENTER** to confirm. The pump offers revolutions per minute or flowrate as dosing flow units.
- Use the **UP** and **DOWN** keys to select **RPM** or **Flowrate**. Press **ENTER** to confirm. The pump records the user's preference and displays the Lock Start ramp screen.

Note: The choice of flowrate units may be made later. See 19.7 *Flow units*.

Lock start ramp

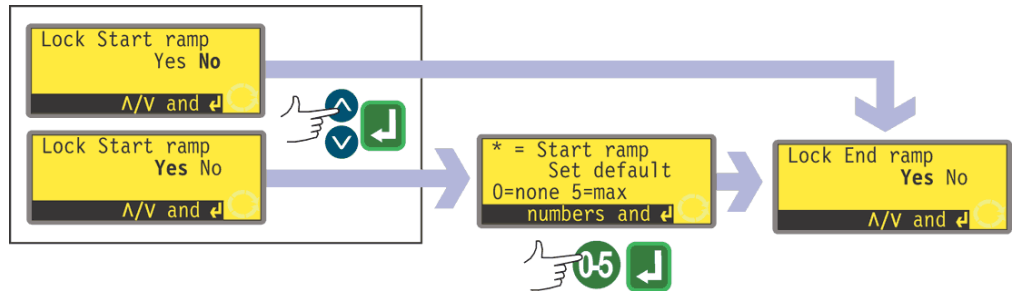

The user can choose between pre-setting and locking the Start ramp setting so that it cannot be altered by dispense programs during operation - Yes - or leaving it free to be altered by dispense programs during operation - No.

- Use the **UP** and **DOWN** keys to select **Yes** or **No** from the Lock start ramp screen. Press **ENTER** to confirm.
- If **No** is selected, the Start ramp setting is left to dispense programs. The pump displays the Lock end ramp screen.

- If **Yes** is selected, the pump displays the Start ramp pre-setting screen, showing the pre-setting of the last dosing session. When set to 0 the pump starts abruptly at full speed. When set to 5 the pump accelerates softly to full speed.
- If the setting displayed is correct, press **ENTER**. The pump displays the Lock end ramp screen.
- If you wish to change the setting, use the numeric keys to enter the desired setting: **0, 1, 2, 3, 4** or **5**. To quickly return to the starting value, press **SHIFT, 5 (CLEAR)**. If a number greater than 5 is entered, 5 is displayed and entered. Press **ENTER** to confirm. The pump displays the Lock end ramp screen.

Lock end ramp

The user can choose between pre-setting and locking the End ramp setting so that it cannot be altered by dispense programs during operation - Yes - or leaving it free to be altered by dispense programs during operation - No.

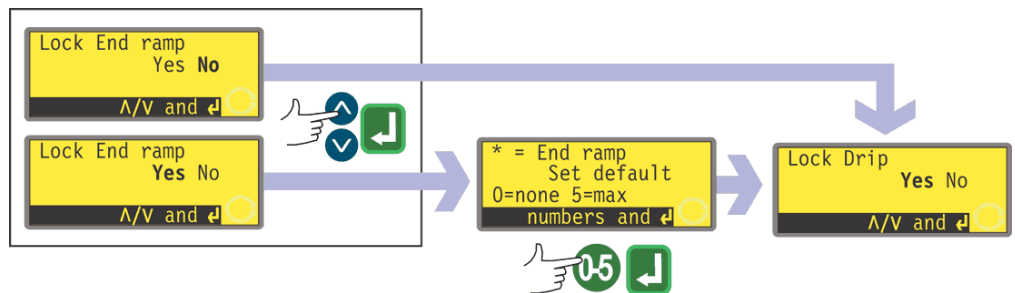

- Use the **UP** and **DOWN** keys to select **Yes** or **No** from the Lock end ramp screen. Press **ENTER** to confirm.
- If **No** is selected, the End ramp setting is left to dispense programs. The pump displays the Lock drip screen.
- If **Yes** is selected, the pump displays the End ramp pre-setting screen, showing the pre-setting of the last dosing session. When set to 0 the pump stops abruptly. When set to 5 the pump decelerates softly to a stop.
- If the setting displayed is correct, press **ENTER**. The pump displays the Lock drip screen.
- If you wish to change the setting, use the numeric keys to enter the desired setting: **0, 1, 2, 3, 4** or **5**. To quickly return to the starting value, press **SHIFT, 5 (CLEAR)**. If a number greater than 5 is entered, 5 is displayed and entered. Press **ENTER** to confirm. The pump displays the Lock drip screen.

Lock drip

The user can choose between pre-setting and locking the Drip setting so that it cannot be altered by dispense programs during operation - Yes - or leaving it free to be altered by dispense programs during operation - No.

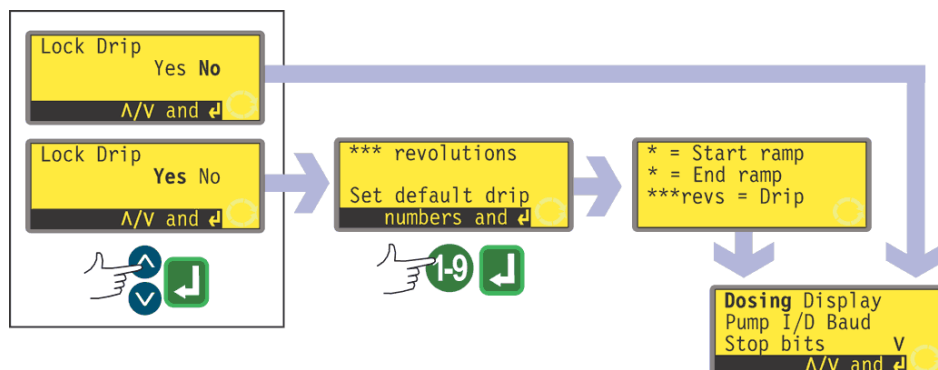

- Use the **UP** and **DOWN** keys to select **Yes** or **No** from the Lock drip screen. Press **ENTER** to confirm.
- If **No** is selected, the drip setting is left to dispense programs. The pump redisplay the first screen of the Setup menu.
- If **Yes** is selected, the pump displays the Drip pre-setting screen, showing the pre-setting of the last dosing session: from 0 to 1.0 (zero to one revolution) at one-tenth of a revolution intervals.
- If the setting displayed is correct, press **ENTER**. The pump confirms the Start ramp, End ramp and Drip settings for four seconds and redisplay the first screen of the Setup menu.
- If you wish to change the setting, use the numeric keys to enter the desired setting: zero revolutions to 1 revolution at 0.1 revolution intervals. To quickly return to the starting value, press **SHIFT, 5 (CLEAR)**. If a number greater than 1.0 is entered, 1.0 is displayed and entered. Press **ENTER** to confirm. The pump confirms the Start ramp, End ramp and Drip settings for four seconds and redisplay the first screen of the Setup menu.

19.2 Display

The user can choose revolutions per minute or flowrate as flow units for manual pumping (as distinct from dosing flow units).

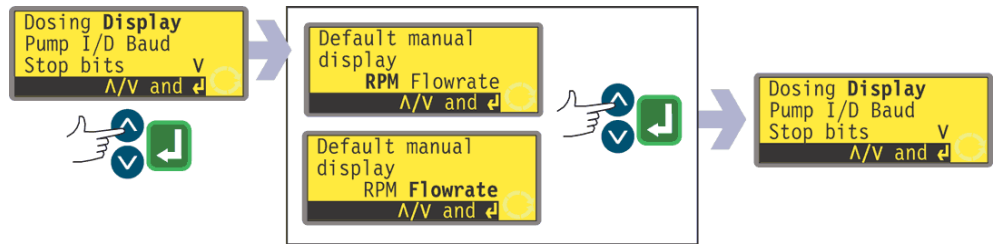

- Use the **UP** and **DOWN** keys to select **Display** from the first screen of the Setup menu. Press **ENTER** to confirm. The pump offers revolutions per minute or flowrate as manual pumping flow units.
- Use the **UP** and **DOWN** keys to select **RPM** or **Flowrate**. Press **ENTER** to confirm. The pump records the user's preference and redisplay the first screen of the Setup menu.

Note: The choice of flowrate units may be made later. See 19.7 *Flow units*.

19.3 Pump number

The pump can be individually controlled under RS232 as one of up to 16 pumps (520Di), or under RS485 as one of up to 32 pumps (520DiN). First it must be given its identity number.

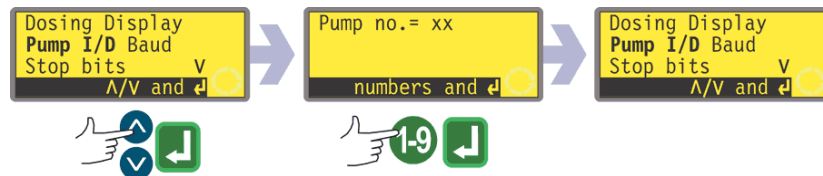

- Use the **UP** and **DOWN** keys to select **Pump I/D** from the first screen of the Setup menu. Press **ENTER** to confirm. The pump displays any previously set I/D number.
- If the setting displayed is correct, press **ENTER**. The pump redisplay the first screen of the Setup menu.
- If you wish to change the setting, use the numeric keys to enter the desired setting: 1-16 for RS232 or 1-32 for RS485. To quickly return to the starting value, press **SHIFT, 5 (CLEAR)**. If a number greater than 16 / 32 is entered, 16 / 32 is displayed and entered. Press **ENTER** to confirm. The pump redisplay the first screen of the Setup menu.

Note: Pumps can be given an identification number of 1-32 for RS232 or 1-64 for RS485 if required. Access the extended range by means of a combination keypress. Use the numeric keys to enter 16. Press **UP** and **4 (MAX)** together. The full range of identification numbers is now available.

19.4 Baud

The pump can be set to communicate with RS232 devices (520Di) or RS485 devices (520DiN) at a choice of baud rates.



- Use the **UP** and **DOWN** keys to select **Baud** from the first screen of the Setup menu. Press **ENTER** to confirm. The pump displays any previously set baud rate.
- If the setting displayed is correct, press **ENTER**. The pump redisplay the first screen of the Setup menu.
- If you wish to change the setting, use the **UP** and **DOWN** keys to select **1200**, **2400**, **4800**, **9600** or (520DiN only) **19k2** and press **ENTER** to confirm.
- The pump redisplay the first screen of the Setup menu.

19.5 Stop bits

The pump can be set to communicate with RS232/RS485 devices at a choice of stop bits settings.



- Use the **UP** and **DOWN** keys to select **Stop bits** from the first screen of the Setup menu. Press **ENTER** to confirm. The pump displays any previously setting.
- If the setting displayed is correct, press **ENTER**. The pump redisplay the first screen of the Setup menu.
- If you wish to change the setting, use the **UP** and **DOWN** keys to select **2**, **1** or **0** and press **ENTER** to confirm.
- The pump redisplay the first screen of the Setup menu.

19.6 Xon/Xoff

The pump can be set to communicate with RS232/RS485 devices using Xon/Xoff flow control.

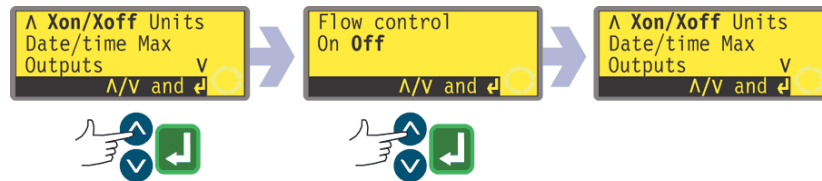

- Use the **UP** and **DOWN** keys to select **Xon/Xoff** from the second screen of the Setup menu. Press **ENTER** to confirm. The pump displays the previous setting.
- If the setting displayed is correct, press **ENTER**. The pump redisplayes the second screen of the Setup menu.
- If you wish to change the setting, use the **UP** and **DOWN** keys to select **On** or **Off** and press **ENTER** to confirm.
- The pump redisplayes the second screen of the Setup menu.

19.7 Flow units

The pump can display its flowrate in metric (SI) or US (imperial) units of volume or mass.

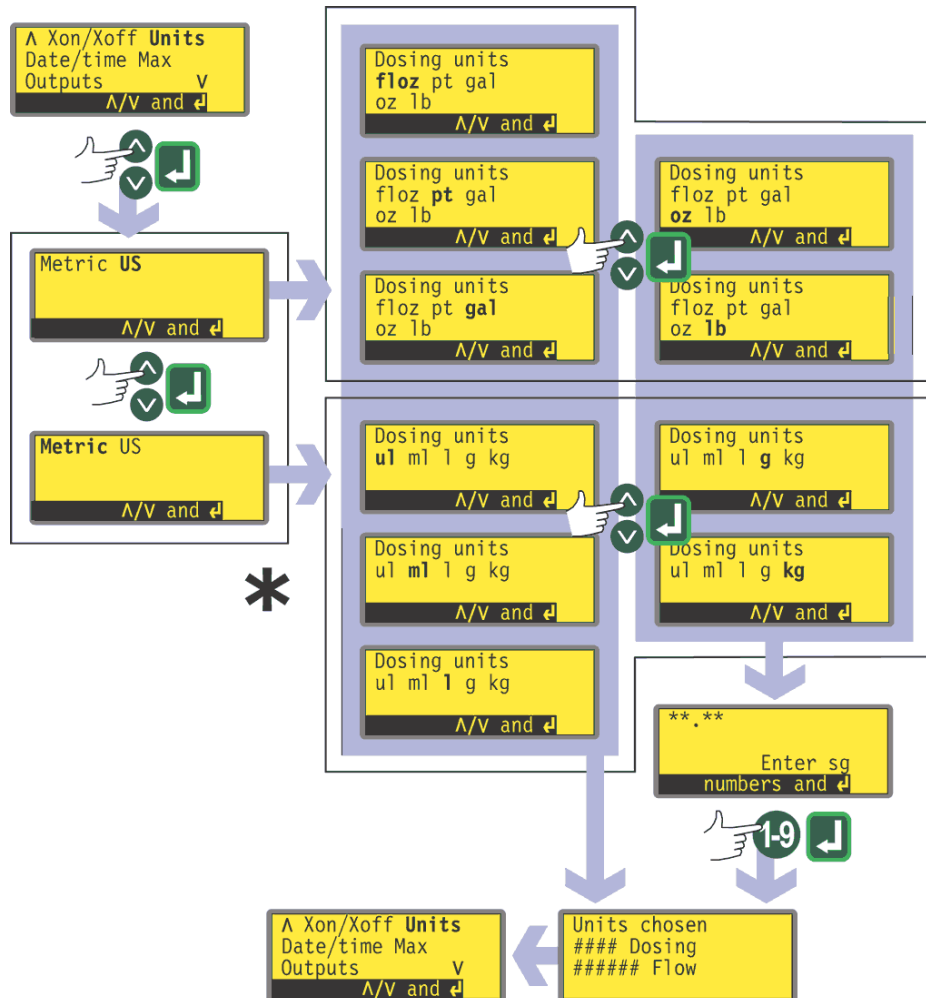

* **Note:** “ul” shown here and used on pump displays represents “ μ l” (microlitres).

- Use the **UP** and **DOWN** keys to select **Units** from the second screen of the Setup menu. Press **ENTER** to confirm.
- The pump displays a screen offering Metric or US. Use the **UP** and **DOWN** keys to choose **Metric** or **US**. Press **ENTER** to confirm.
- If you chose Metric, the pump offers a choice of units. Use the **UP** and **DOWN** keys to choose **μ l**, **ml**, **l**, **g** or **kg** and press **ENTER** to confirm.
- If you chose US, the pump offers a choice of units. Use the **UP** and **DOWN** keys to choose **floz**, **pt**, **gal**, **oz** or **lb** and press **ENTER** to confirm.

- If you chose a volumetric flow rate from either screen, a confirmation screen appears briefly and the pump redisplay the second screen of the Setup menu.
- If you chose a mass flowrate from either screen, the pump asks for the specific gravity of the fluid to be pumped. Use the numeric keys to enter a value between 0.01 and 15. If a number greater than 15 is entered, 15 is displayed and entered. Press **ENTER** to confirm your decision. Press **STOP** if you decide to make a different choice of units.
- A confirmation screen appears briefly and the pump redisplay the second screen of the Setup menu.

Di, DiN

19.8 Date and time

To record dosing sessions the pump's real-time clock needs to know the date and time.

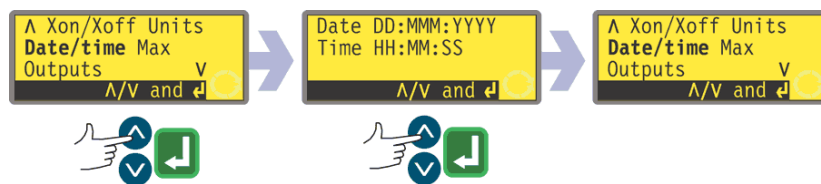

- Use the **UP** and **DOWN** keys to select **Date/time** from the second screen of the Setup menu. Press **ENTER** to confirm. The pump displays any previous setting.
- If the setting displayed is correct, press **ENTER**. The pump redisplay the second screen of the Setup menu.
- If you wish to change the setting, use the **UP** and **DOWN** keys to enter the current date (two digits), month (three letters), year (four digits), hour, minute and second (all two digits), pressing **ENTER** to confirm each one.
- When **ENTER** is pressed to confirm the seconds, the pump redisplay the second screen of the Setup menu.

19.9 Max key operation

The pump must be primed - its tube filled with duty fluid - if it is to dispense immediately. This is done by pressing and holding **SHIFT, 4 (MAX)** to operate the pump at full speed until duty fluid reaches the discharge port. Priming ceases when **SHIFT, 4 (MAX)** is released. **SHIFT, 4 (MAX)** can be set to function in a narrow or a wide range of circumstances.

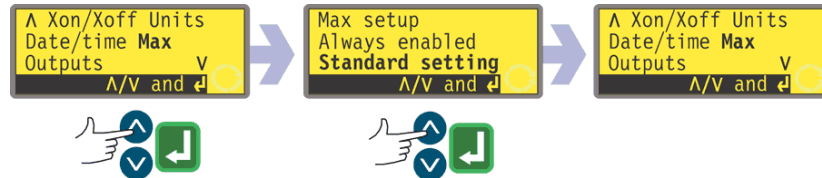

- Use the **UP** and **DOWN** keys to select **Max** from the second screen of the Setup menu. Press **ENTER** to confirm.
- Use the **UP** and **DOWN** keys to select **Standard setting** if you want **SHIFT, 4 (MAX)** to invoke priming only when the pump is in Manual mode or Dose mode while waiting for a press on **START** to begin dosing. Select **Always enabled** if you want **SHIFT, 4 (MAX)** to invoke priming when the pump is in Manual mode, Calibrate or Dose mode while stopped. Press **ENTER** to confirm. The pump redisplay the second screen of the Setup menu.

Note: **SHIFT, 4 (MAX)** has no effect in Network or Setup mode.

19.10 Outputs

The pump offers four digital status outputs. See 12 *Switching the pump on for the first time* for initial start-up defaults. Each of seven parameters can be configured to any output, or more than one output.

The parameters are:

Run / stop

Provides a status output to indicate whether the pumphead is running or stopped at all times. When running at 0 rpm, the run / stop output indicates running.

General alarm

Provides an alarm output when any system error condition occurs except: leak detected; analogue signal out of range; analogue over-signal; analogue no signal.

Direction

Provides a status output to indicate which direction the pump is set to run in.

Leak detected

When used with a leak detector, this output provides an alarm when the pump has been automatically switched off following tube failure.

Net / man

Provides a status output to indicate whether the pump is under network control or manual control.

Dose

Provides a status output to indicate whether the pumphead is running or stopped while dosing is taking place.

Batch

Provides a status output to indicate whether a dispense batch is in progress.

Di

Output 1 and output 2 are available in two formats:

- From pins 10 and 11, lower D-connector, as 5V TTL signals.
- From pins 10 and 11, upper D-connector, as open collector logic outputs.

Output 3 and output 4 provide open collector logic outputs from pins 13 and 12, upper D-connector, respectively.

A supply voltage from the pump (5V, 10V, 12V) or user-supplied up to 24V to pin 22, upper D-connector, provides the voltage level for these logic status outputs.

See 20.1.5 *Logic outputs*

DiN

Outputs 1-4 are available as single-pole change-over relay contacts: Relay 1, 2, 3 and 4. Connect to the normally open or normally closed contacts of the relay as required and configure the pump's software accordingly. See below in this section.

See 20.2.7 *Outputs* in Automatic control wiring.

Note: The maximum rating on the relay contacts of this pump is 30VDC; maximum load 30W.

Di, DiN

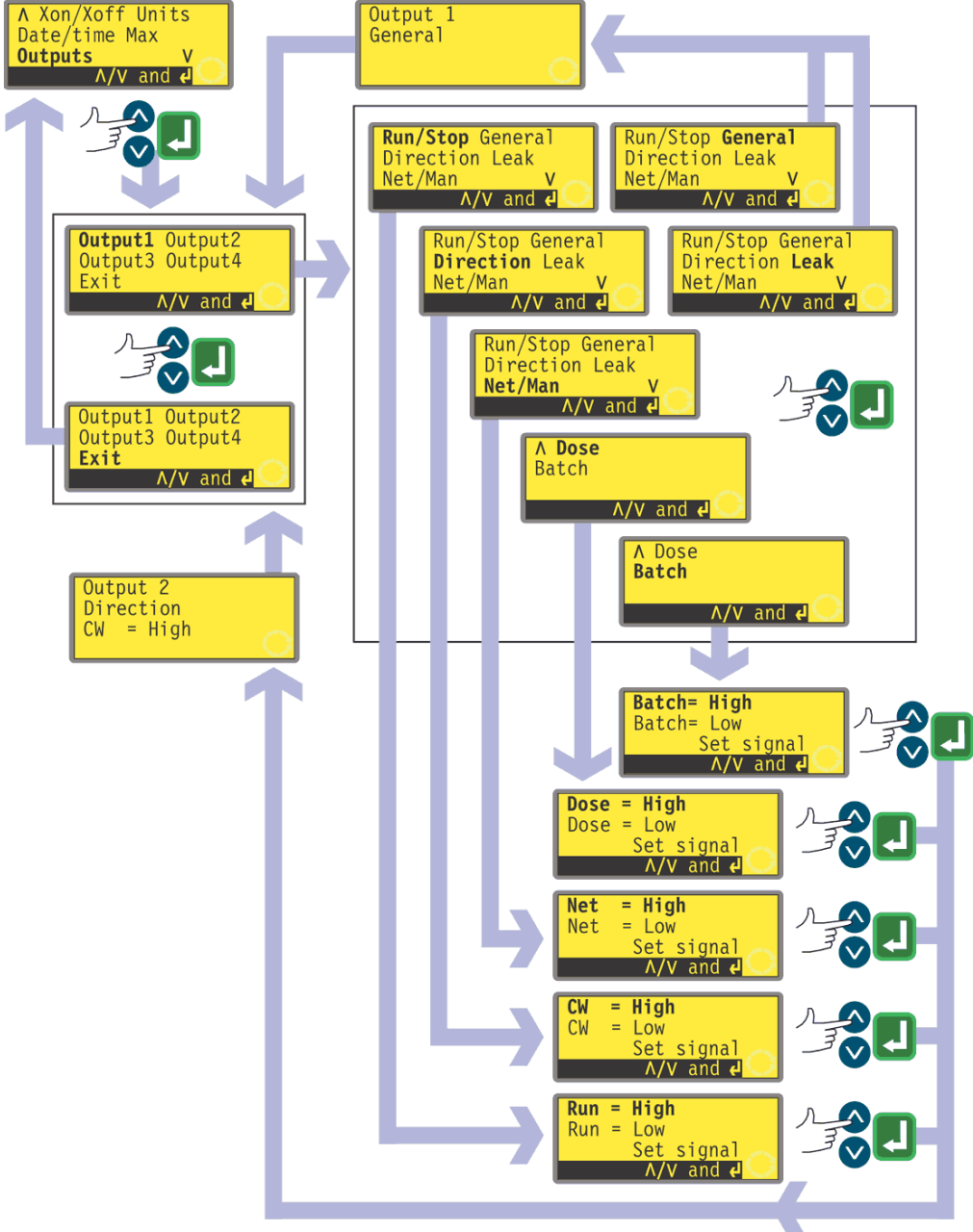

- Use the **UP** and **DOWN** keys to select **Outputs** from the second screen of the Setup menu. Press **ENTER** to confirm.
- The pump displays the Output selection screen, from which you can configure each of the four outputs, or exit this menu. Use the **UP** and **DOWN** keys to choose and press **ENTER** to confirm.
- If **Output 1** is chosen, the pump displays the Options menu.

The Outputs menu occupies two screens.

To move from one screen to the next, repeatedly press **DOWN**. Each item is highlighted in turn until the last item on the screen is highlighted.

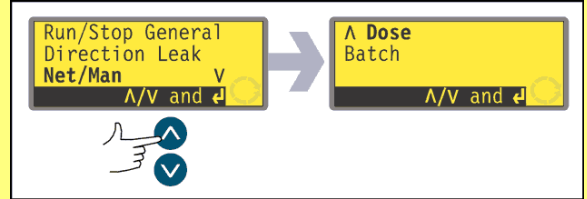

A further press on the **DOWN** key displays the next screen of the menu, with the first item highlighted.

Follow the reverse procedure using the **UP** key to move to an item on the first screen of the menu.

- Selecting **General** or **Leak** using the **UP** and **DOWN** keys and confirming the choice by pressing **ENTER** configures that option to Output 1, displays a confirmation screen, and returns the user to the Output selection screen. An example is shown here.
- Selecting **Run/Stop**, **Direction**, **Net/Man**, **Dose** or **Batch** using the **UP** and **DOWN** keys and confirming the choice by pressing **ENTER** displays screens allowing the user to configure Run to **High** or **Low**, Clockwise to **High** or **Low**, Net to **High** or **Low**, Dose to **High** or **Low**, and Batch to **High** or **Low** respectively. Choose using the **UP** and **DOWN** keys and press **ENTER** to confirm. The option chosen is configured to Output 1. The pump displays a confirmation screen, and returns the user to the Output selection screen. An example is shown here.
- The user can configure **Output 2**, **Output 3** and **Output 4** in the same way, or choose **Exit**.
- If **STOP** is pressed during configuration, the previous setting for the output is retained and the pump redisplay the Output selection screen.
- If **Exit** is chosen, the pump returns the user to the second screen of the Setup menu.

Outputs 1-4: First-time start-up defaults

Output 1	Dose	= high
Output 2	Direction	Clockwise = high
Output 3	Net/Man	Net = high
Output 4	General alarm	

19.11 Remote stop

The pump can be started and stopped with a remote switch. Disabling the remote stop control does not disable other remote controls. See 20.1 *Run / stop input*.

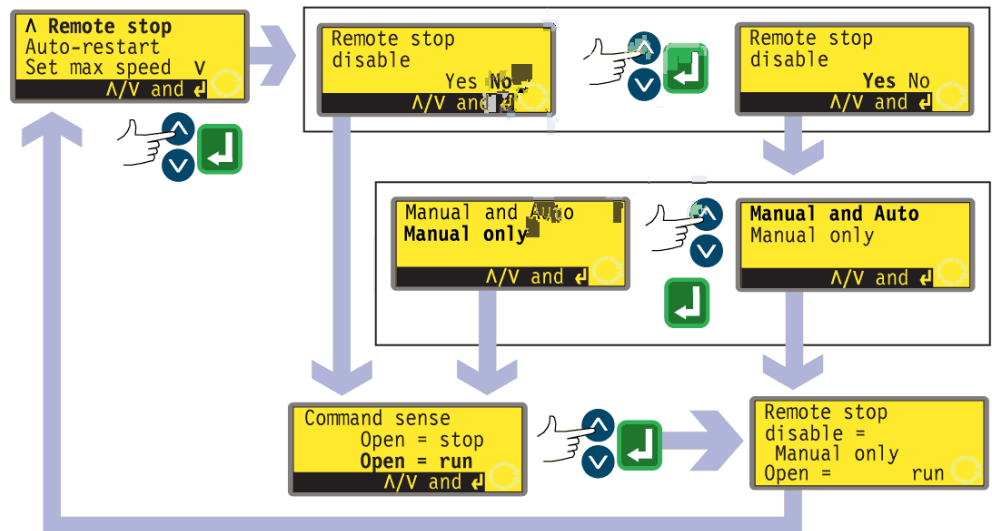

- In the third screen of the Setup menu select **Remote stop** using the **UP** and **DOWN** keys. Press **ENTER** to confirm your choice.
- The pump displays a screen allowing the user to disable the remote stop feature. Use the **UP** and **DOWN** keys to choose **Yes** or **No** and press **ENTER** to confirm the decision.
- If **No** is chosen, the pump asks the user to make a further choice, according to whether the pump is required to run on an open or closed remote switch: **Open=stop** or **Open=run**. Choose using the **UP** and **DOWN** keys and press **ENTER** to confirm. The pump briefly displays a confirmation screen (an example is shown here) and returns the user to the third screen of the Setup menu.
- If **Yes** is chosen, the pump asks the user whether the remote stop feature is to be disabled fully (for both manual and auto operation), or only for manual operation, leaving remote stop functioning when the pump is operating in auto mode. Choose using the **UP** and **DOWN** keys and press **ENTER** to confirm. If manual and auto was chosen, the pump briefly displays a confirmation screen (an example is shown here) and returns the user to the third screen of the Setup menu. If manual only was chosen, the pump asks the user to make a further choice, according to whether the pump (with remote control available in auto mode only) is required to run on an open or closed remote switch: **Open=stop** or **Open=run**. Choose using the **UP** and **DOWN** keys and press **ENTER** to confirm. The pump briefly displays a confirmation screen (an example is shown here) and returns the user to the third screen of the Setup menu. **Note:** The confirmation screen indicates whether Remote stop is enabled or disabled, and displays the command sense of the remote control switch **even if Remote stop has been disabled**.

Alternatively ...

- To toggle the sense of the remote run / stop control between open=stop and open=run: stop the pump. Turn off the mains power switch at the rear of the pump.
- Hold down the **STOP** key and the **1 (DIRECTION)** key, and turn on the mains power switch. The **UP** and **DOWN** keys can then be used to toggle the sense of remote run / stop control between open=stop and open=run.

See 20.1.1 *Run / stop input*.

Di, DiN

19.12 Auto-restart

This pump offers an auto-restart feature. If active on power loss, it restores the pump when power returns to the operating state it was in when power was lost. It does not operate when powering down in the middle of a dose: when the pump is restarted, it will wait for a press on the **START** key to begin the interrupted dose again. Auto-restart is retained while the pump is switched off. When the pump starts running, look for the ! symbol on the display. This ! symbol indicates that the pump is set for auto-restart.

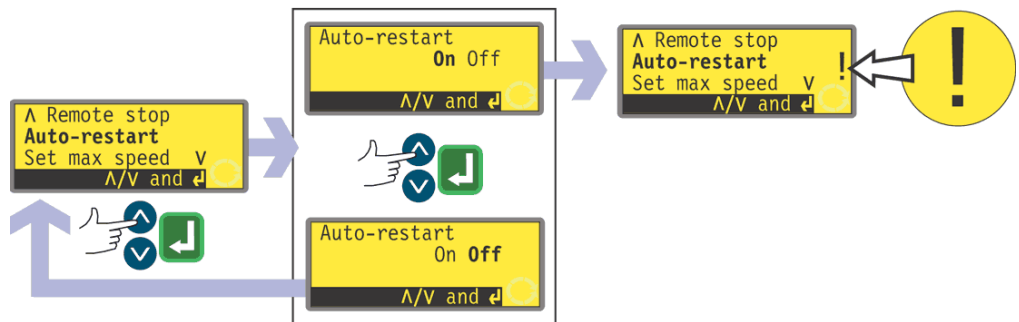

- Use the **UP** and **DOWN** keys to select **Auto-restart** from the third screen of the Setup menu. Press **ENTER** to confirm.
- The pump displays a screen allowing the user to activate auto-restart. Use the **UP** and **DOWN** keys to choose **On** or **Off** and press **ENTER** to confirm.
- If **Off** is chosen, the pump returns the user to the third screen of the Setup menu. The auto-restart facility will not operate.
- If **On** is chosen, the pump returns the user to the third screen of the Setup menu, where an exclamation mark (!) is now visible. This mark confirms that the auto-restart feature is in place and will operate the next time power is lost and restored.

Alternatively ...

- Stop the pump. Turn off the mains power switch at the rear of the pump.
- Hold down the **START** key and turn on the mains power switch. The ! symbol shows on the display.
- Start the pump. If the mains supply is interrupted the pump will automatically restart when the mains power returns.
- To remove auto-restart switch off the mains power at the rear of the pump. Hold down the **STOP** key and turn the mains power switch on. The ! symbol does not appear.



Do not use auto-restart for more than 100 starts per hour. We recommend remote control where a high number of starts is required.

Di, DiN

19.13 Set maximum allowed speed

The pump's maximum speed can be limited for operational purposes.



- Use the **UP** and **DOWN** keys to select **Set max speed** from the third screen of the Setup menu. Press **ENTER** to confirm.
- The pump displays a screen allowing the user to set the maximum speed of the pump equal to or lower than the maximum available. Use the numeric keys to set the maximum allowed speed and press **ENTER** to confirm.
- The pump returns the user to the third screen of the Setup menu.
Note: The maximum speed available depends on the pumphead selected during calibration.

19.14 Backlight

The pump's display can be illuminated or not according to choice.



- Use the **UP** and **DOWN** keys to select **Backlight** from the fourth screen of the Setup menu. Press **ENTER** to confirm.
- The pump displays a screen allowing the user to switch the display backlight on or off. Use the **UP** and **DOWN** keys to choose **On** or **Off** and press **ENTER** to confirm.
- The pump returns the user to the fourth screen of the Setup menu. The display is now illuminated or not according to the user's decision.

Alternatively ...

- To turn the backlight off: press **STOP** and **DOWN** together while the pump is stopped.
- To turn the backlight on: press **STOP** and **UP** together while the pump is stopped.

19.15 ROM

The pump can display its software version, model number and pump speed.



- Use the **UP** and **DOWN** keys to select **ROM** from the fourth screen of the Setup menu. Press **ENTER** to confirm.
- The pump displays the software version, model number (520Di for 520Di and 520DiN) and the maximum allowed pump speed for four seconds (an example is shown here), then returns the user to the fourth screen of the Setup menu. It also displays a checksum: CHK 123, for example. This may be required if reporting pump performance to the Watson-Marlow service department.

Alternatively ...

- Press **DOWN** and **1 (DIRECTION)** together in Manual mode to interrupt the display and show the pump's ROM version for four seconds.

19.16 Pin out details

Pin out details

Selecting **Pin out details** causes the pump to display its preset pin and voltage details under 13 headings: **Direction enable, Direction input, Run/Stop input, Leak input, Dose input, Output 1, Output 2, Output 3, Output 4, Supply, 0 volts, Earth** and **Others**. No user input is available in this section; it displays information only.

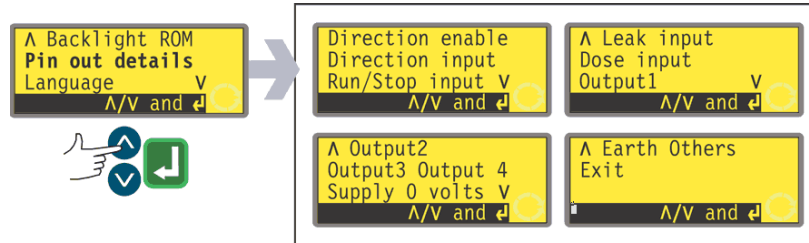

- Use the **UP** and **DOWN** keys to select **Pin out details** from the fourth screen of the Setup menu. Press **ENTER** to confirm.

The Pin out details menu

The Pin out details menu occupies four screens. The first two are shown here.

To move from one screen to subsequent screens, repeatedly press **DOWN**. Each item is highlighted in turn until the last item on the screen is highlighted.

A further press on the **DOWN** key displays the next screen of the menu, with the first item highlighted.

Follow the reverse procedure using the **UP** key to move to an item on a previous screen of the menu.

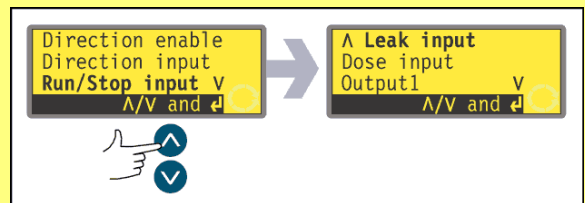

- Use the **UP** or **DOWN** keys to make a selection. Press **ENTER** to confirm.
- The information on pinouts duplicates the details described in this instruction manual under 20 *Automatic control wiring*.
- The screens available are all presented in a similar manner. For example, on selecting **Run/Stop input**, the following screen is displayed:

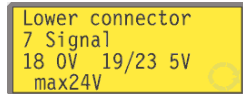

```

Lower connector
7 Signal
18 0V 19/23 5V
max24V
  
```

This indicates that the analogue input signal must be applied to pin 7 of the lower D-connector at the rear of the pump, where 0 volts is available on pin 18 and 5 volts on pins 19 to 23. The maximum permitted voltage is 24 volts.

Pressing **STOP** or **ENTER** in any Pin out information screen returns the user to the appropriate Pin out menu screen.

Note: The information available on selecting **Supply** and **Others** is presented on two screens each. Pressing **DOWN** when the last item of the first screen of each is highlighted will cause the second screen to appear with its first item highlighted. **UP** performs a similar function.

To leave the Pin out menu screens

- Cycle through the Pin out menu screens until the fourth screen is displayed. Use the **UP** and **DOWN** keys to select **Exit** and press **ENTER** to confirm.

Alternatively ...

- Repeatedly press **STOP** to go back level by level until the Main menu is displayed.

DiN

Pin out information is not relevant to the 520DiN IP66/NEMA 4X pump. Selecting **Pin out details** causes the pump to display a warning screen and redisplay the main menu.

19.17 Language

The pump can be set to operate in several languages.



- Use the **UP** and **DOWN** keys to select **Language** from the fourth screen of the Setup menu. Press **ENTER** to confirm.
- In the next screen, choose a language using the **UP** and **DOWN** keys. Press **ENTER** to confirm. The pump redisplay the fourth Setup screen in your chosen language. All screens will subsequently appear in your chosen language.

19.18 Defaults

All the pump's user-set data can be reset to factory defaults.

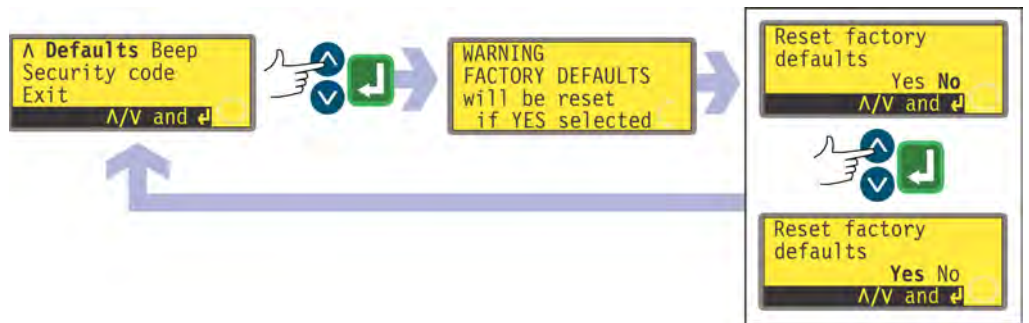

- Use the **UP** and **DOWN** keys to select **Defaults** from the fifth screen of the Setup menu. Press **ENTER** to confirm.
- A warning is displayed for four seconds, and the pump asks the user to confirm that factory defaults are to be reset. Use the **UP** and **DOWN** keys to choose **Yes** if you wish the pump to reset all user-set data back to factory defaults (see 12 *Switching the pump on for the first time*); or **No** if you do not wish to do this. Press **ENTER** to confirm. If **Yes** was chosen, the pump resets its factory defaults and redisplay the fifth Setup screen. If **No** was chosen, the pump makes no changes to its setup and redisplay the fifth Setup screen.

19.19 Beep

The pump keypad can operate silently or indicate a positive key-press with a beep sound.

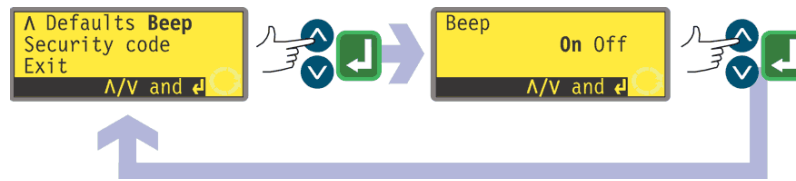

- Use the **UP** and **DOWN** keys to select **Beep** from the fifth screen of the Setup menu. Press **ENTER** to confirm.
- In the next screen, use the **UP** and **DOWN** keys to choose **On** or **Off**. Press **ENTER** to confirm. The pump redisplay the fifth Setup screen.

Alternatively ...

To toggle the sound on and off, stop the pump. Turn off the mains power switch at the rear of the pump.

Depress the **UP** and **1 (DIRECTION)** keys while switching on the mains power switch at the rear of the pump.

19.20 Security code

Access to the pump's Setup, Dose and Calibration menus, direction control and keypad lock can be restricted to those who correctly enter a three-digit security code: the main code. A secondary user code can be set, which permits PIN access to calibration, direction, and keypad lock, but blocks access to Setup and Dose. See 19 Setup, 17 Calibrate, 18.1 Keypad functions in manual mode and 14.1 Keypad functions when not in manual mode.

The code must first be set.

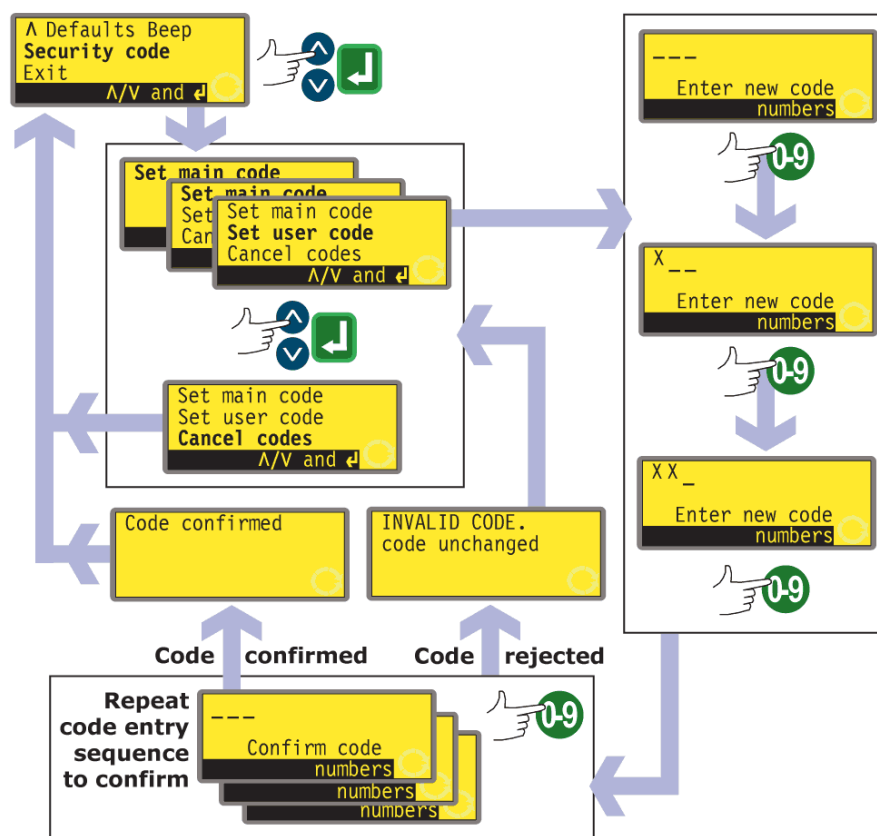

- In the fifth screen of the Setup menu select **Security code** using the **UP** and **DOWN** keys. Press **ENTER** to confirm.
- If no code has been set, a screen is displayed inviting the user to set a main code. Press **ENTER** to proceed (or **STOP** to return to the fifth screen of the Setup menu).
- If a main code has been set, a screen is displayed inviting the user to set a new main code, to set a user code (or a new user code if one has already been set), or to cancel all codes. Choose **Set main code**, **Set user code** or **Cancel codes** using the **UP** and **DOWN** keys. Press **ENTER** to confirm your choice.
- If you chose **Cancel codes**, any codes previously set are cancelled and access to the pump is not restricted.
- If you chose **Set main code** or **Set user code**, the pump displays a screen with three blank spaces for digits and the instruction "Enter new code". Use the numeric keys to enter three digits. The pump displays a similar three-digit entry screen and the instruction "Confirm code".

- Repeat the digit-entry sequence.
- If the second three-digit code entered differs from the first, or if the digits chosen as a user code are the same as those already set as a main code, the pump briefly displays an error message and redisplay the set code options screen.
- If the codes tally and, for a user code, if there is no clash with a previously set main code, the pump briefly displays a confirmation message and redisplay the sixth Setup screen. Access to the Setup and Configuration menus, Dose, direction control and keypad lock is now protected by the new security code.
- If **STOP** is pressed during code entry, the pump returns the user to the fifth Setup screen. If **STOP** is pressed during code confirmation, the pump returns the user to the first digit-entry screen.

Note: A user code cannot be set unless a main code has previously been set. If you wish to cancel only a user code, you must use **Cancel codes** to cancel both user and main codes, then use **Set main code** to set a new main code.

Note: If a code has been set but forgotten, it is still possible to access the Setup screens to cancel the code or reset it to another three-digit number. Contact your supplier or Watson-Marlow Technical support for the bypass sequence.

Di, DiN



19.21 Exit

- Use the **UP** and **DOWN** keys to select **Exit** from the fifth screen of the Setup menu. Press **ENTER** to confirm.
- The user is returned to the Main menu.

20 Automatic control wiring

Di

20.1 IP31 Automatic control wiring

Interfacing the pump with other devices is by means of three D-connectors at the rear of the pump. There are two 25-way D-connectors. The top one is male, the bottom one is female. Mating female and male connectors, screened for EMC compatibility, must be conventionally soldered to screened control cables.

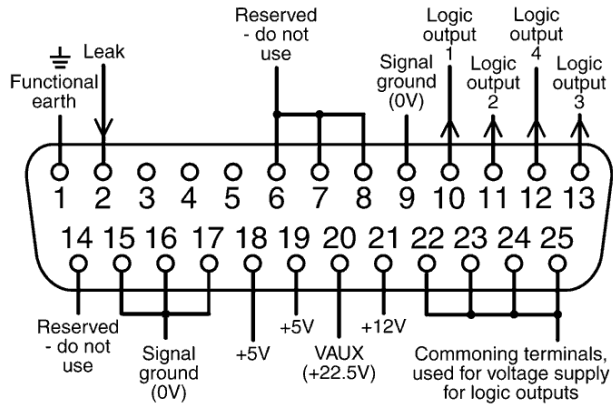

Upper D-connector

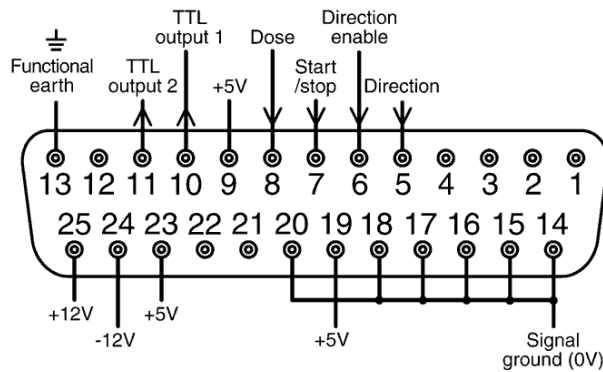

Lower D-connector

Recommended control cable: 7 strands 0.2mm, 24AWG, screened, circular, up to 25-core. The cable screen should be earthed either through the functional earth pin on the D-connector (pin 1 on the upper (male) 25-way D-connector) (pin 13 on the lower (female) 25-way D-connector), or through the metalwork of the socket or plug.

This pump passes all EMC compatibility requirements with up to 25m (82ft) of the cable type specified above. Beyond this distance it is the user's responsibility to ensure the pump's safe and reliable operation under remote and automatic control.

Do not strap the control and mains power cables together.

The 0V lines on this pump are mains transformer-isolated from ground (floating ground). It can be connected to isolated 0V or grounded 0V interfaces. The TTL (transistor transistor logic) outputs 1 and 2 used here are composed of two states: nominally 0V and 5V; but in practice <0.4V (<0.4mA) and 2.4-5V (<16mA). They are not suitable for driving relays. If a relay is to be driven by the TTL signal, it must be done as described under 20.2.7 *Outputs 1, 2, 3, 4*, below.

 **Never apply mains voltage to the D-connectors. Apply the correct signals to the pins shown. Limit signals to the maximum values shown. Do not apply voltage across other pins. Permanent damage, not covered by warranty, may result.**

Di

20.1.1 Run / stop input

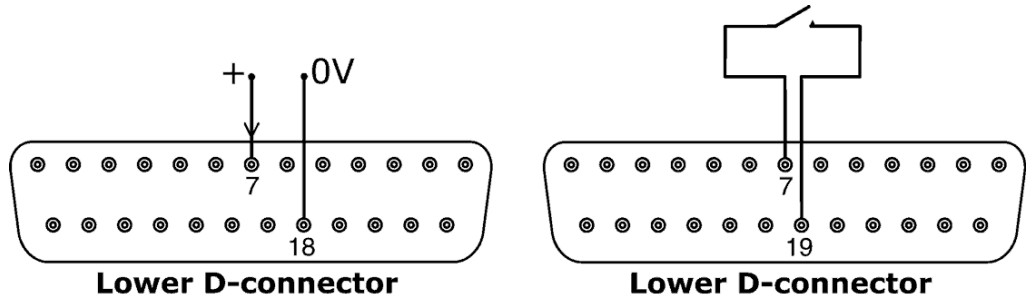

Remote run / stop: connect a remote switch between pins 7 and 19 of the lower D-connector. Alternatively a logic input may be applied to pin 7 of the lower D-connector, ground to pin 18. High input stops the pump, low input runs the pump. With no connection or with the switch open, the pump will default to running. To change or set the sense of the run / stop input, see 19.11 *Remote stop* in the Setup menu.

20.1.2 Direction input

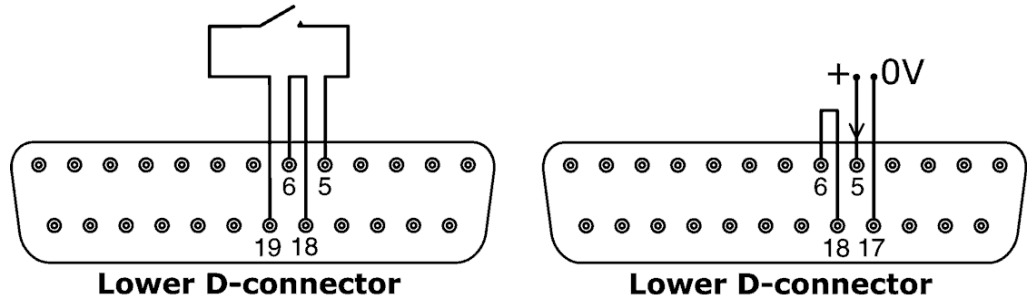

To enable remote direction control and disable the **DIRECTION** key on the keypad, link pins 6 and 18 of the lower D-connector. Connect a remote switch between pins 5 and 19 of the lower D-connector. Open switch for clockwise rotation, closed switch for counter-clockwise rotation. Alternatively a logic signal may be applied to pin 5 of the lower D-connector, ground to pin 17. Low input for clockwise rotation, high input for counter-clockwise rotation. With no connection the pump defaults to clockwise rotation.

20.1.3 Dose input

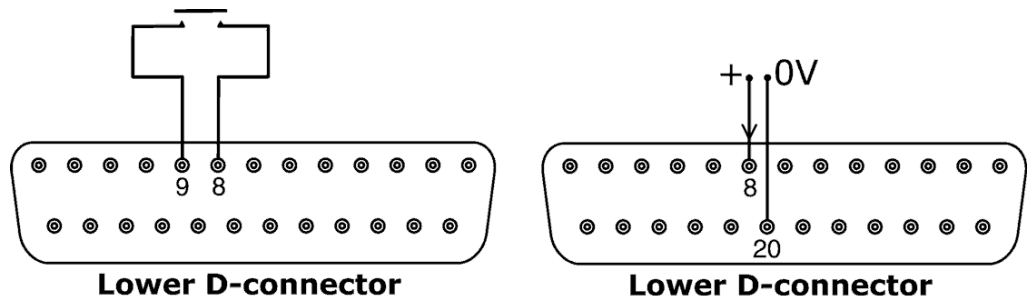

Connect a momentary contact switch such as a footswitch or a handswitch between pins 8 and 9 of the lower D-connector. Close the switch to begin a dose. This input is software-debounced and functions in a similar way to the other remote inputs, such as with 5V to 24V logic as shown above, using pin 8 as the input and pin 20 as the 0V (lower D-connector).

Note: This input is software-debounced, so the signal can be either momentary or maintained during the dose. If maintained, the signal must be removed before the next dose.

Note: Connect only one pump through one switch. If several pumps must be started at once, use multiple poles and isolate each circuit.

20.1.4 Leak detection input

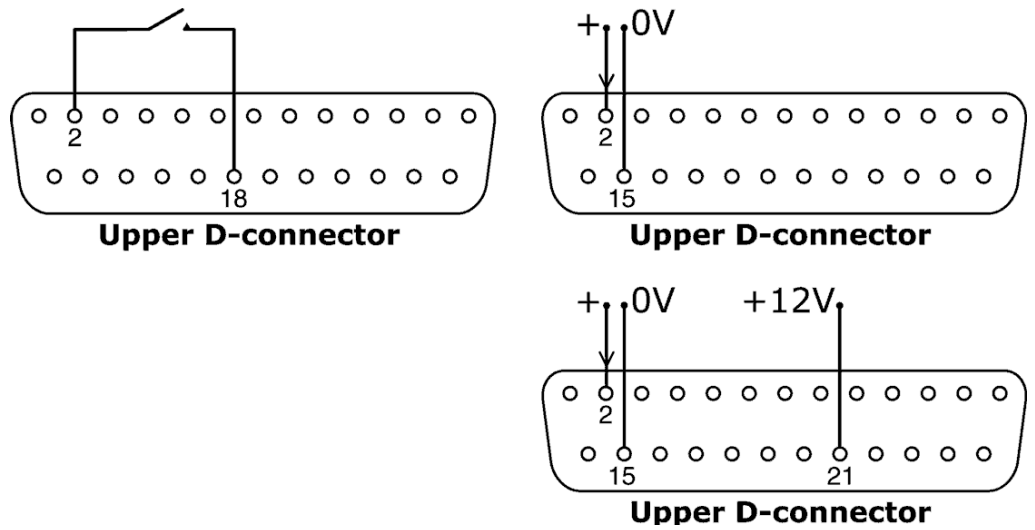

Connect a remote leak-detection device between pins 2 and 18 of the upper D-connector. Closed circuit indicates a leak. Alternatively a logic input may be applied to pin 2 of the upper D-connector, ground to pin 15. High input indicates a leak. Connect a Watson-Marlow leak detector in the same way, drawing 12V to power it from pin 21 of the upper D-connector.

Connect the cable of a Watson-Marlow Tube monitor leak detector as follows:

Tube monitor wire colour	Pin number, upper D connector
Blue	15
Yellow	2
Red	21

Note: Use only a Watson-Marlow 520 series tube monitor.

Important: pump status outputs

All four outputs can be configured in software to output a range of parameters: see 19.10 *Outputs* under Setup.

Outputs 1 and 2 are available simultaneously from the upper and lower D-connectors. The outputs from the lower D-connector are backwards-compatible with 505U pumps. They operate at 5V TTL only.

All four outputs available from the upper D-connector are open-collector.

By applying a positive voltage to a maximum of 24V to pin 22 of the upper D-connector, all the outputs from this plug are at that voltage: pin 22 is commoned with pins 23, 24 and 25. Care must be taken to ensure that the supply voltage has sufficient capability to drive all the loads applied to all outputs used. **Important: The total load of the four logic outputs must not exceed 50mA.**

Di

20.1.5.1 Logic output 1

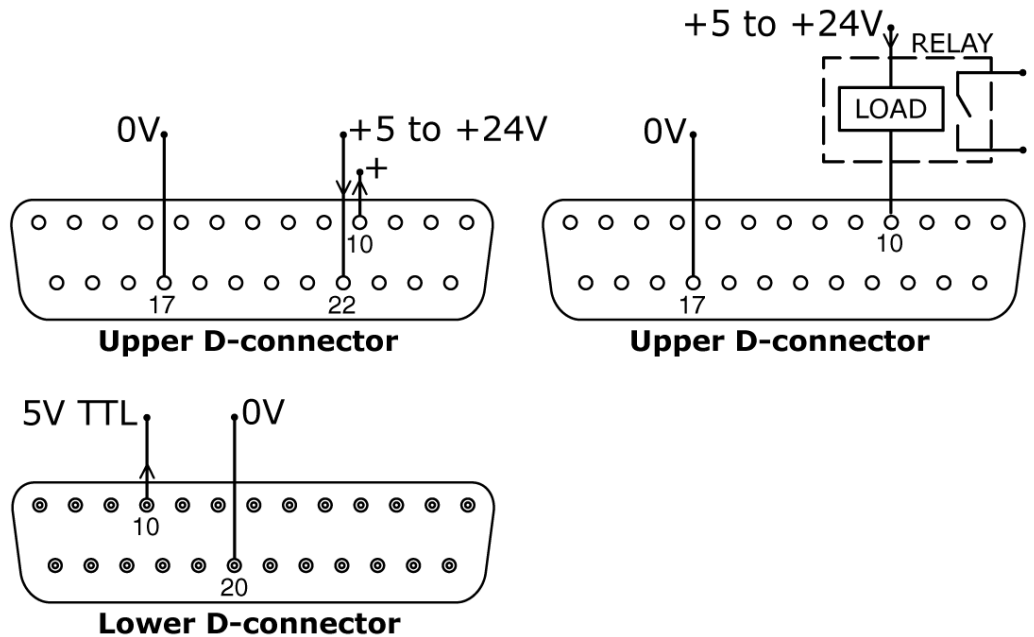

Output 1 is taken from pin 10 of the upper D-connector, depending on the logic state of the function assigned to Output 1. Alternatively, a load such as a relay coil may be connected to pin 10, ground to pin 17. Current will flow through the circuit depending on the logic state of the function assigned to Output 1. Do not connect to any device requiring more than 50mA.

Additionally, output 1 is available as a 5V TTL logic signal on pin 10 of the lower D-connector. It will change state corresponding to the logic state of the function assigned to Output 1. Do not connect to any device requiring more than 1 TTL load.

By default, output 1 is configured to indicate Dose status. See 12 *Switching the pump on for the first time*.

Di

20.1.5.2 Logic output 2

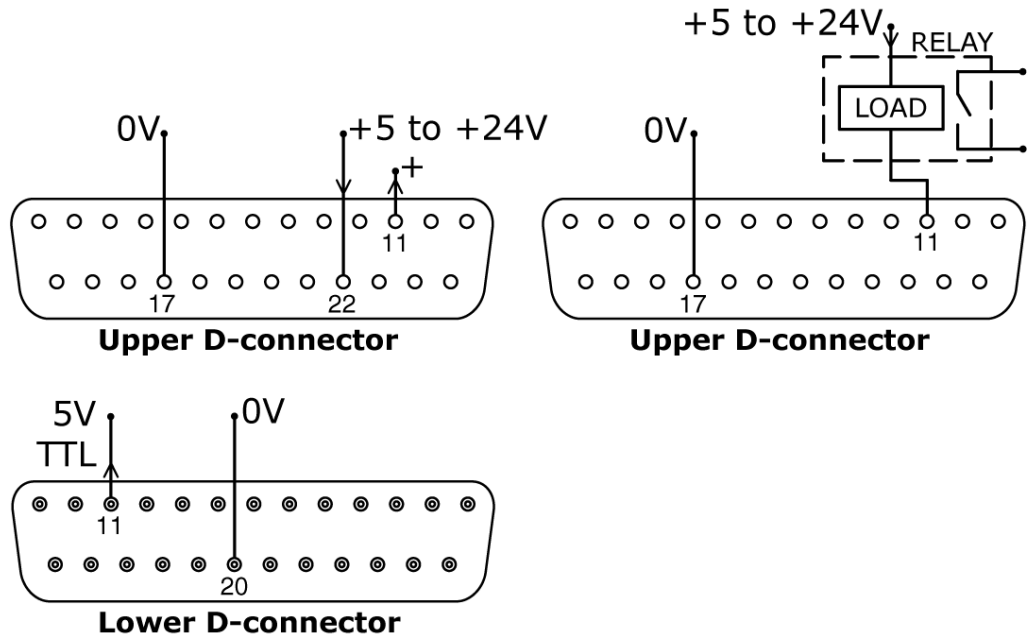

Output 2 is taken from pin 11 of the upper D-connector, depending on the logic state of the function assigned to Output 2. Alternatively, a load such as a relay coil may be connected to pin 11, ground to pin 17. Current will flow through the circuit depending on the logic state of the function assigned to Output 2. Do not connect to any device requiring more than 50mA.

Additionally, output 2 is available as a 5V TTL logic signal on pin 11 of the lower D-connector. It will change state corresponding to the logic state of the function assigned to Output 2. Do not connect to any device requiring more than 1 TTL load.

By default, output 2 is configured to indicate Direction status. See 12 *Switching the pump on for the first time*.

20.1.5.3 Logic output 3

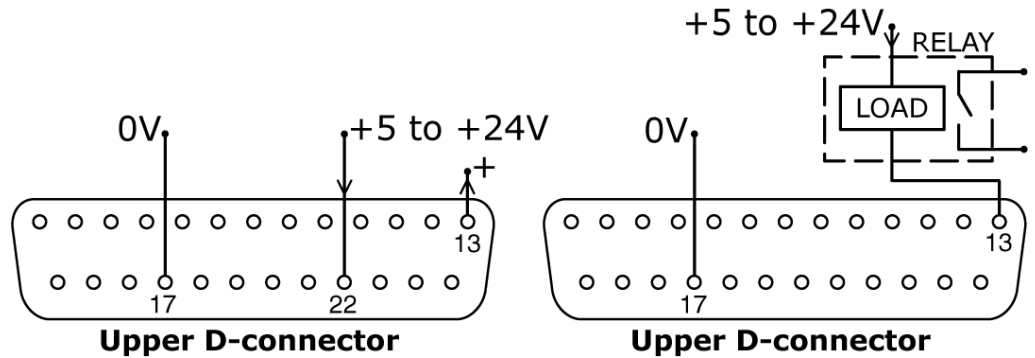

Output 3 is taken from pin 13 of the upper D-connector, depending on the logic state of the function assigned to Output 3. Alternatively, a load such as a relay coil may be connected to pin 13, ground to pin 17. Current will flow through the circuit depending on the logic state of the function assigned to Output 3. Do not connect to any device requiring more than 50mA.

By default, output 3 is configured to indicate Net/Man status. See 12 *Switching the pump on for the first time*.

20.1.5.4 Logic output 4

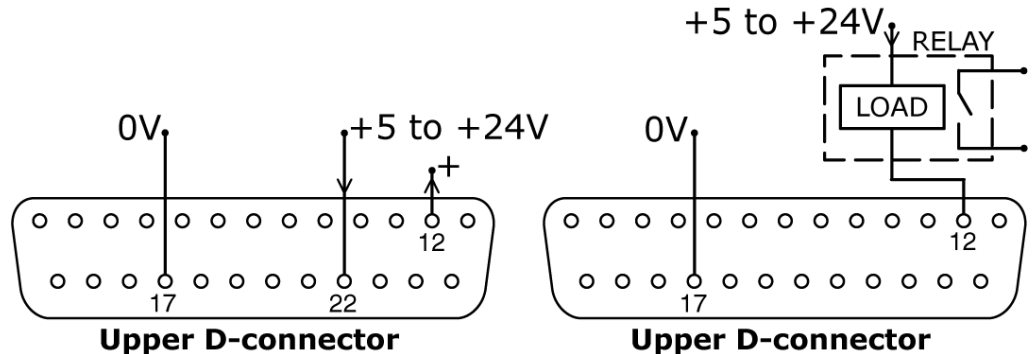

Output 4 is taken from pin 12 of the upper D-connector, depending on the logic state of the function assigned to Output 4. Alternatively, a load such as a relay coil may be connected to pin 12, ground to pin 17. Current will flow through the circuit depending on the logic state of the function assigned to Output 4. Do not connect to any device requiring more than 50mA.

By default, output 4 is configured to indicate General alarm status. See 12 *Switching the pump on for the first time*.

20.1.6 Supply voltages

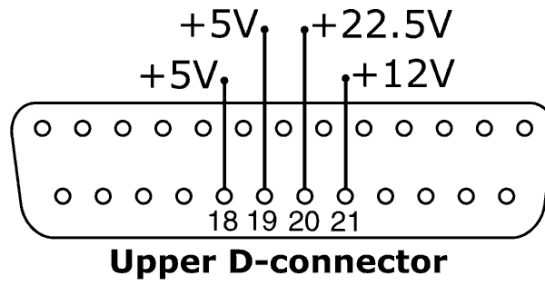

Upper D-connector

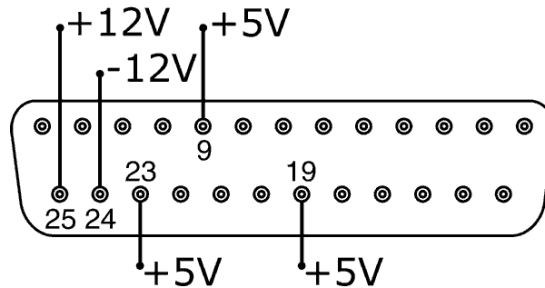

Lower D-connector

In the table below, "Max load" is the maximum total load on each supply irrespective of the number of connections.

DC Voltage	Max load	Lower D	Upper D	Typical use
+5V	10mA	9, 19, 23	18, 19	Voltage supply for inputs using remote switch. Possible voltage supply for outputs if only 5V is required. Pin 9 is specifically used for footswitch / handswitch operation
+12V	10mA	25	21	Possible voltage supply for inputs using remote switch. Possible voltage supply for outputs. Voltage supply for Watson-Marlow Tube Monitor leak detector. Part voltage supply (-12V also needed) for the Watson-Marlow proximity switch.
-12V	10mA	24	—	Part voltage supply (+12V also needed) for the Watson-Marlow proximity switch.
+22.5V	—	—	20	Voltage supply for the 520N wash-down module. Do not use.
+10V	—	21	—	Reference voltage for remote potentiometer speed control. Do not use as a general supply voltage.

Note: All DC supplies are stabilised except the +22.5V.

20.2 IP66 Automatic control wiring

Interfacing the pump with other devices is by means of screw-terminal connectors within the 520N watertight module at the rear of the pump. Suitable cable must be passed into the module through one or more watertight cable glands and connected appropriately. The module must be removed to allow this.



It is important to check the pump's voltage setting to ensure that it matches the supply. The voltage selection switch is on the rear panel of the drive. The module must be removed (and replaced) to allow it to be checked.

20.2.1 520N module removal and replacement

To remove the 520N watertight module:

The module is secured to the back of the drive unit by six M5x12 Pozidriv counter-sunk stainless steel screws.



- Remove the six screws using a suitable crosspoint screwdriver, leaving the top centre screw till last. Even when all screws have been removed, the sealing strip may cause the module to adhere to the drive. If so, a gentle tap will free it. Do not use a tool to lever it off.
- The sealing strip should be retained within its channel on the face of the module. The transparent on/off switch cover should be retained on its flange on the face of the module. Check the integrity of the seal and the transparent on/off switch cover. If either is damaged, it must be renewed to maintain ingress protection.

- If necessary, unplug the two 25-way D-connectors linking the module to the pump drive. If necessary, remove the module's earth link from the back of the drive. However, the link is long enough to allow the module to fold back to give access to the circuit board inside and to the back of the drive.

To replace the 520N watertight module:



- Check that the fuse in the fuseholder (ringed) in the centre of the switchplate does not need to be replaced. Check that the voltage selector switch is correctly set for your power supply.
- Check that the sealing strip (seen white here for clarity) is fully in its channel on the face of the module.
- Attach the module's earth link wire. Replace and tighten its screw to 2Nm.
- Push home the female (upper) and male 25-way D-connectors on to their counterparts on the rear of the drive.
- Hold the module in place, taking care not to disturb the seal or pinch the earth link wire or D-connector ribbon cables, and screw in the six retaining screws (top centre screw first). Tighten to 2.5Nm.

Note: Ensure that the 520N module is properly fitted at all times using all six screws. Without the module and the screws, the screw holes may corrode and IP66 (NEMA4X) protection will be compromised.

20.2.2 Wiring up

It is the user's responsibility to ensure the pump's safe and reliable operation under remote and automatic control.

The 0V lines on this pump are commoned and mains transformer-isolated from ground (floating ground). It can be connected to isolated 0V or grounded 0V interfaces.

Cable entry to the module is via up to four watertight cable glands. These may be fitted in place of the sealing plugs which are fitted to the back of the module when the pump is shipped.



The number of glands needed depends on the number of connection cables required and the convenience of the installer. As standard, four M16 cable glands are provided with the pump.

Recommended control cable conductors for the terminal blocks: metric = 0.14sq mm - 2.5sq mm solid and 0.14sq mm - 1.5sq mm stranded. USA = 26AWG - 14AWG solid and 26AWG - 16AWG stranded. Cable: circular. Max/min outside diameter to ensure a seal when passed through the standard gland: 9.5mm-5mm. **The cable section must be circular to ensure a seal.**

For EMC protection, shielded control cable should be used. The shielding should be terminated to one of the pcb mounting screws or to the adjacent spade connector (where fitted).

For improved EMC protection in extremely noisy environments, shielded cable may be used in conjunction with watertight metal EMC cable glands. These must be earthed to the module by adding an M16x1.5 nut with serrated edges to ensure proper contact with the inside of the module. It is necessary to remove the module's circuit board to access the interior of the module: it is held in place by two fixing screws which can be removed and replaced with a cross-point screwdriver. Take normal anti-static precautions when handling printed circuit boards.

Suitable cables for general-purpose use: 300V with extra premium grade PVC jacket with good flame and moisture resistance.

Suitable cables for industrial use: 300V extra-rugged polyurethane grade jacket with resistance to oils, fuels, solvents and water.

For convenience of wiring more than 8 conductors per cable may be awkward to handle. Only two appear in the illustrations here, for clarity.

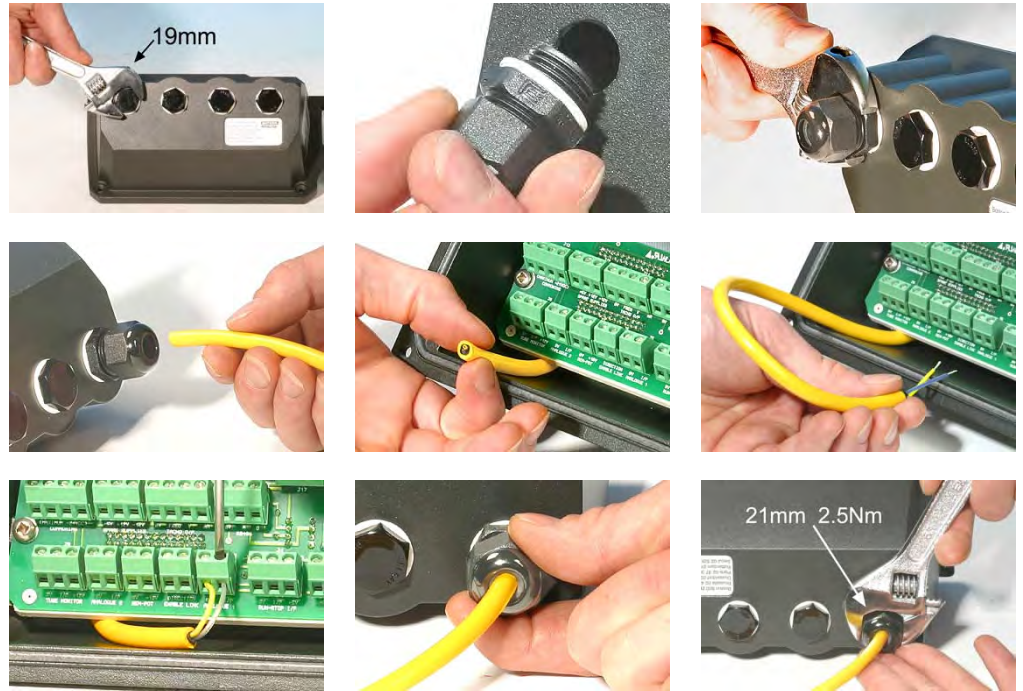



- Use a 19mm spanner to unscrew the sealing plug. Discard the nylon sealing washer.
- Screw in one of the supplied M16x1.5 cable glands in place of the plug, using the new nylon sealing washer supplied. Tighten the gland to 2.5Nm to ensure a seal, using a 21mm spanner. If a different gland is used, it must be watertight to IP66.
- Loosen the gland cap (do not remove it) and pass the cable in through the gland. When it has passed through the gland, continue to push the cable through.
- The inside of the module is shaped to guide the cable past the printed circuit board inside. Continued pushing will feed in enough cable to grip inside the module with the fingers.
- Pull through sufficient cable to reach the connectors required. Leave a little slack.

- Strip the outer sheath as necessary and remove 5mm of insulation from the conductors. No tinning or ferrule is required. **Note:** If very stiff or large-diameter cable is used, it may be convenient to strip the outer sheath before passing the cable's conductors through the gland. However, to ensure a seal, cable with an undamaged sheath must be present within the gland when it is tightened.
- Twist a suitable length of the cable screen. Loosen one of the pcb retaining screws and wrap the screen end round it. Refasten the screw. Alternatively, secure the cable screen to the adjacent spade connector (where fitted).
- Push the bared conductor into the square hole in the connector. When the conductor is fully in, tighten the retaining screw to hold it in place.
- When all conductors are in position, use a 21mm spanner to tighten the gland cap to 2.5Nm to ensure a seal. Alternatively, tighten the gland by hand until it is finger-tight and use a spanner to tighten it further by one-half a turn.

Note: Do not strap the control and mains power cables together.

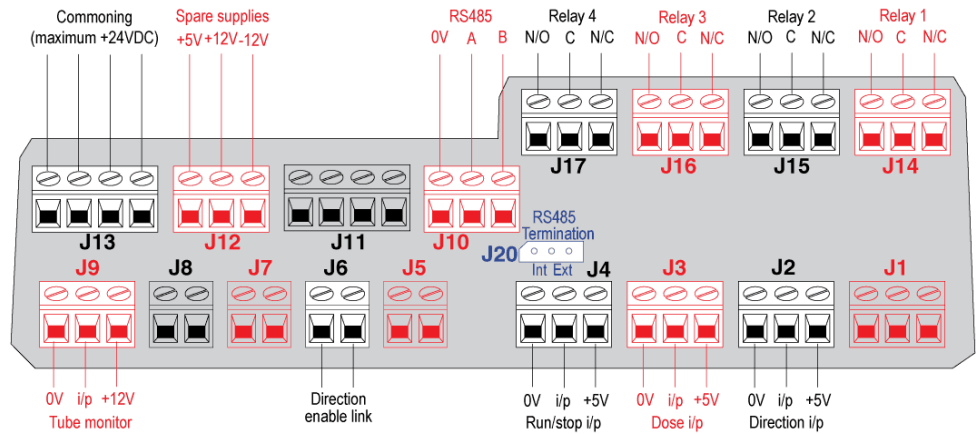
520N watertight module pcb connectors:



 **Never apply mains power to the terminals within the 520N module. Apply the correct signals to the terminals shown below. Limit signals to the maximum values shown. Do not apply voltage across other terminals. Permanent damage, not covered by warranty, may result. The maximum rating on the relay contacts of this pump is 30V DC; maximum load 30W. Note: Also suitable for low power: ie, 1mA at 5VDC minimum.**

Typical connections

Inputs

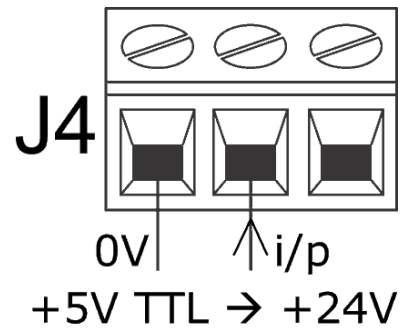
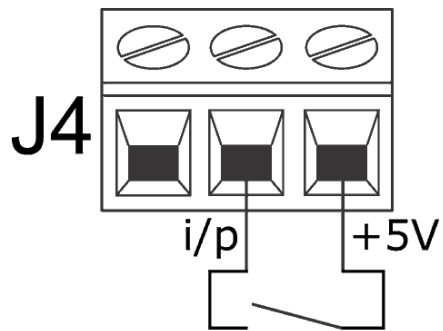

Run / stop and other change-of-state commands can be switched, above left, or accomplished by a logic signal, above right.

Outputs

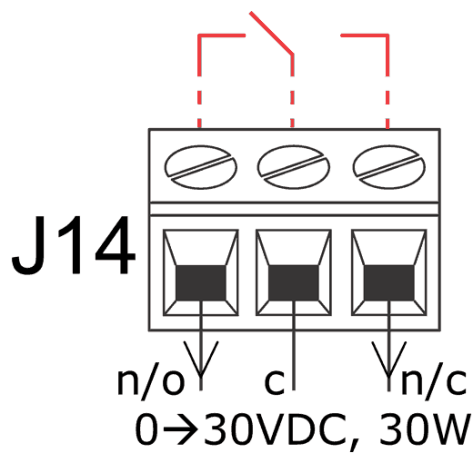

Relay output 1, showing (red) its internal configuration

DiN

20.2.3 Run / stop input

Remote run / stop: connect a remote switch between the **i/p** terminal and the **+5V** terminal of the Run/stop i/p connector (J4). Alternatively a logic input may be applied to the **i/p** terminal, ground to the **0V** terminal. High input stops the pump, low input runs the pump. With no connection or with the switch open, the pump will default to running. To change or set the sense of the run / stop input, see 19.11 *Remote stop* in the Setup menu.

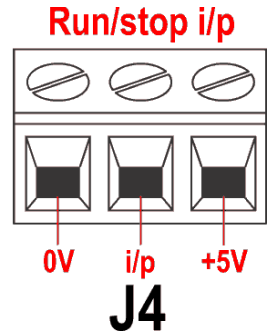

DiN

20.2.4 Direction input

To enable remote direction control and disable the **SHIFT, 1 (DIRECTION)** key on the keypad, link the terminals of the Direction enable link connector (J6). **Important: Apply no voltage whatever to the Direction enable link** (J6). Connect a remote switch between the **+5V** terminal and the **i/p** terminal of the Direction i/p connector (J2). Open switch for clockwise rotation, closed switch for counter-clockwise rotation. Alternatively a logic signal may be applied to the **i/p** terminal and the **0V** terminal of the Direction i/p connector (J2). Low input for clockwise rotation, high input for counter-clockwise rotation. With no connection the pump defaults to clockwise rotation.

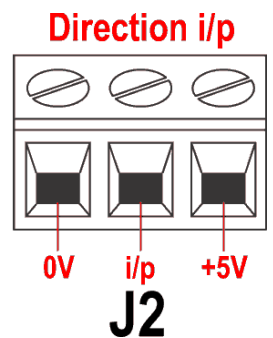
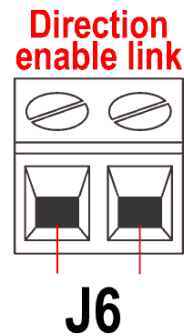

20.2.5 Dose input

Connect a momentary contact switch such as a footswitch or a handswitch between the **5V** terminal and the **i/p** terminal of the Dose i/p connector (J3). Close the switch to begin a dose. This input is software-debounced and functions in a similar way to the other remote inputs, such as with 5V to 24V logic as shown above, using the **i/p** terminal and the **0V** terminal.

Note: This input is software-debounced, so the signal can be either momentary or maintained during the dose. If maintained, the signal must be removed before the next dose.

Note: Connect only one pump through one switch. If several pumps must be started at once, use multiple poles and isolate each circuit.

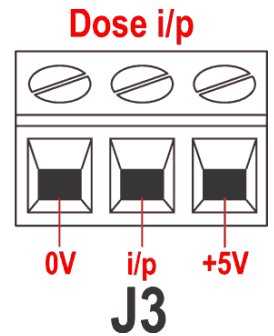

20.2.6 Leak detection input

Connect a remote leak-detection device between the **+12V** terminal and the **i/p** terminal on the Tube monitor connector (J9). Closed circuit indicates a leak. Alternatively a logic input may be applied to the **i/p** terminal, ground to the **0V** terminal. High input indicates a leak. Connect the cable of a Watson-Marlow Tube monitor leak detector as follows:

Tube monitor wire colour	520N module
Blue	J9 0V terminal
Yellow	J9 i/p terminal
Red	J9 +12V terminal
Terminate the screen in the 520N module with a 360° EMC gland if required. See 20.2 <i>Wiring up</i> .	

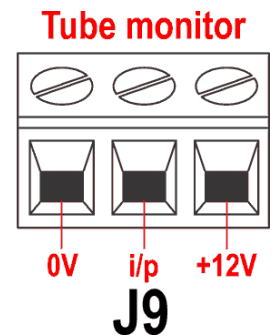

Note: Use only Watson-Marlow 520 series tube monitors.

Important: pump status outputs

Outputs 1-4 are available as single-pole change-over relay contacts: Relay 1, 2, 3 and 4. Connect to the normally open or normally closed contacts of the relay as required and configure the pump's software accordingly. See 19.10 *Outputs*.

Note: The maximum rating on the relay contacts of this pump is 30V DC; maximum load 30W.

Note: Also suitable for low power: ie, 1mA at 5VDC minimum.

DiN

20.2.7 Outputs 1, 2, 3, 4

Note: Relay 1 (J14) is represented here. Relay 2, Relay 3 and Relay 4 (J15, J16 and J17) function identically.

Connect your output device to the **c** (common) terminal of your chosen relay connector and either the **n/c** terminal or the **n/o** terminal (normally closed or normally open) as required. Configure the pump's software accordingly. See 19.10 *Outputs*.

By default, Relay 1 is configured to indicate Run/Stop status; Relay 2 is configured to indicate Direction status; Relay 3 is configured to indicate Auto/man status; Relay 4 is configured to indicate General alarm status. See 12 *Switching the pump on for the first time*.

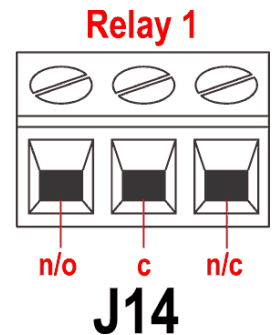

20.2.8 Supply voltages

An appropriate voltage supply is available where required on each connector. In addition, supplies may be drawn from the Spare supplies connector (J12).

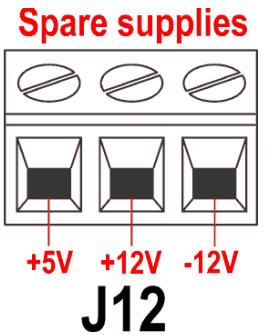

DC Voltage	Max load	Typical use
+5V	10mA	Voltage supply for inputs using remote switch. Possible voltage supply for outputs if only 5V is required.
+12V	10mA	Possible voltage supply for inputs using remote switch. Possible voltage supply for outputs. Voltage supply for Watson-Marlow Tube Monitor leak detector. Part voltage supply (-12V also needed) for the Watson-Marlow proximity switch.
-12V	10mA	Part voltage supply (+12V also needed) for the Watson-Marlow proximity switch.
+10V (from J7)		Reference voltage for remote potentiometer speed control. Do not use as a general supply voltage.

Note: All DC supplies are stabilised.

21 Network control and operation

Di

RS232 control

RS232 network control is available via a 9-pin D-connector wired as below.

RS232 is the mode provided to allow the pump to be controlled by computers and process controllers. It can control every function of the pump, and pass data back to the controller for closed loop operation. Up to 16 pumps can be individually controlled.

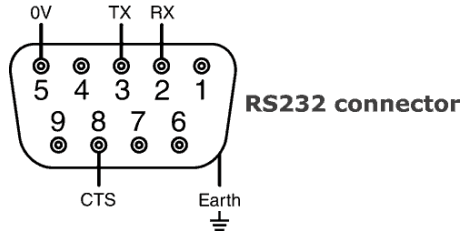

Recommended control cable: 7 strands 0.2mm, 24AWG, screened, circular, up to 4-core. The cable screen should be earthed through the metalwork of the shell.

This pump passes all EMC compatibility requirements with up to 3m (10ft) of the cable type specified above. Beyond this distance it is the user's responsibility to ensure the pump's safe and reliable operation under remote and automatic control.

The 0V lines on this pump are mains transformer-isolated from ground (floating ground).

Basic RS232 cabling

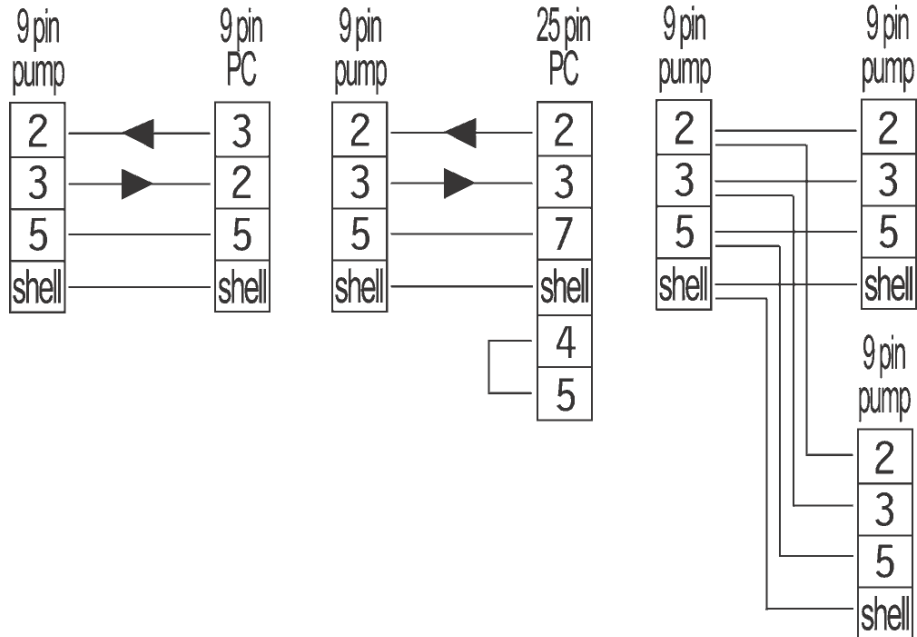

RS232 settings

Baud	Set in Setup, Baud. Factory default is 9600	Parity	None
Stop bits	2	Handshake	None
Data bits	8	Auto echo	On

Pin	Function	Pin	Function
1	—	6	—
2	RX (Receive data)	7	—
3	TX (Transmit data)	8	CTS (clear to send. Active = low)
4	—	9	—
5	OV	Shell	Earth

Note: The CTS connection to pin 8 is optional, for use when error conditions are required.

How to get into network operation

Check that the pump is ready to run before selecting network operation. Remote control signals may start the pump without warning.



- Use the **UP** and **DOWN** keys to select **Network** from the Main menu. Press **ENTER** to confirm.
- The pump enters Network (RS232) mode and is under network control.
- Auto-restart is switched on and the pump displays the (!) icon.
- The only keys active are **STOP** and **SHIFT, 9 (INFO)**.
- Remote stop, Net/man, Direction enable and Direction inputs are inactive. Leak and Dose inputs are active. See 23.1 *Error codes*.
- All pump status outputs are active.

How to get out of network operation

- Pressing the **STOP** key displays three options: **Continue**, **Manual** and **Menu**. Use the **UP** and **DOWN** keys to choose and press **ENTER** to confirm.
 - Selecting **Continue** returns the pump to network (RS232) mode.
 - Selecting **Manual** sets the pump to manual operation and retains the set speed and run status from its previous operation in Network mode. See 18 *Manual operation*.
 - Selecting **Menu** displays the Main menu (see 14 *Main menu*).

Emergency stop

- In an emergency press the **STOP** key. The pump stops and displays an interruption screen, from which select **Continue** to return to network control, **Manual** to set the pump to manual control (see 18 *Manual operation*), or **Menu** to display the main menu (see 14 *Main menu*). Use the **UP** and **DOWN** keys to choose and press **ENTER** to confirm.

DiN

RS485 control

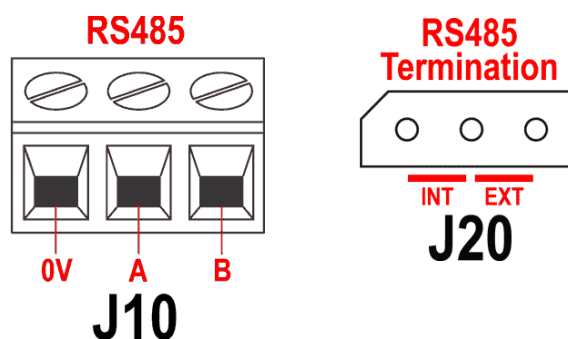

Connect your network link to J10 using a screened twisted pair: A to A, B to B, screen to 0V. Ensure that the pump is configured to operate under Network control. More than one pump may be controlled with the same RS485 signal: connect all pumps in parallel. See 24 *Network control and operation*.

The shorting link at J20 must be correctly positioned to allow RS485 control to function properly. Fit the shorting link of a single pump or of the last pump on a network line in the position marked INT on the three-pin header; fit the shorting link of all other pumps on the network line in the position marked EXT on the three-pin header.

RS485 settings

Baud	Set in Setup, Baud. Factory default is 9600	Parity	None
Stop bits	2	Handshake	None
Data bits	8	Auto echo	On

How to get into network operation

Check that the pump is ready to run before selecting network operation. Remote control signals may start the pump without warning.

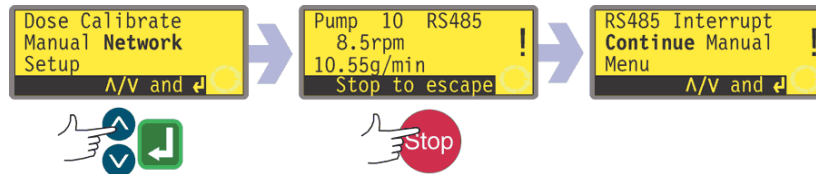

- Use the **UP** and **DOWN** keys to select **Network** from the Main menu. Press **ENTER** to confirm.
- The pump enters Network (RS485) mode and is under network control.
- Auto-restart is switched on and the pump displays the (!) icon.
- The only keys active are **STOP** and **SHIFT, 9 (INFO)**.
- Remote stop, Net/man, Direction enable and Direction inputs are inactive. Leak and Dose inputs are active. See 23.1 *Error codes*.
- All pump status outputs are active.

How to get out of network operation

- Pressing the **STOP** key displays three options: **Continue**, **Manual** and **Menu**. Use the **UP** and **DOWN** keys to choose and press **ENTER** to confirm.
 - Selecting **Continue** returns the pump to network (RS485) mode.
 - Selecting **Manual** sets the pump to manual operation and retains the set speed and run status from its previous operation in Network mode. See 18 *Manual operation*.
 - Selecting **Menu** displays the Main menu (see 14 *Main menu*).

Emergency stop

- In an emergency press the **STOP** key. The pump stops and displays an interruption screen, from which select **Continue** to return to network control, **Manual** to set the pump to manual control (see 18 *Manual operation*), or **Menu** to display the main menu (see 14 *Main menu*). Use the **UP** and **DOWN** keys to choose and press **ENTER** to confirm.

21.1 RS232 and RS485 command strings

Command	Parameters	Meaning
nCA	-	Clear LCD display
nCH	-	Home the cursor
nDO	xxxxxxxxxx <,yyyyy>	Set and run one dose of xxxxxxxxxxxx tachometer pulses, with optional drip of yyyyy (maximum 11,000) tachometer pulses. See note 2
nTC	-	Clear the cumulative tachometer count
nSP	xxx.x	Set speed to xxx.x rpm
nSI	-	Increment speed by 1rpm
nSD	-	Decrement speed by 1rpm
nGO	-	Start running
nST	-	Stop running
nRC	-	Change direction
nRR	-	Set direction to clockwise
nRL	-	Set direction to counter-clockwise
nRS	-	Return status. See note 1
nRT	-	Return the cumulative tachometer count
nW	[line 1]~[line 2]~ [line 3]~[line 4]@	Display text on 1 to 4 lines with ~ as the line delimiter. Terminated by the @ character. See note 3
nZY	-	Return 0 for stopped or 1 for running
nPD	a,b,c,d,e,f,g,h,i,j	Program dose. See note 5
nPD?	520Di,*,#, a,b,c,d,e,f,g,h,i,j	Query dose parameters. See note 9
nPA	-	Query all dose program parameters. See note 8
nCC	-	Clear the batch count
nSC	-	Responds with cccc ! This is the number of complete doses which have been started via the RP command, delivered since the last PD command
nRP	-	Runs the programmed dose and increments the batch count. See note 9
nLP	xxxxxxxx	This allows a saved program to be recalled from NVRAM. The program name is a string of 8 characters precisely. Unused positions must be padded with spaces (ASCII 32)
nCB	xx.xxx	Parameter is a fixed point number representing the new calibration in ml/rev
nD?	-	Reports last full dose dispensed, See note 11
nCF	####	Calibration-on-the-fly new dose value, subject to the $\pm 25\%$ rule. See note 12

Note 1: The status is returned to the sender in the following format: [pump type] [ml/rev] [pumphead] [tube size] [speed] [CW/CCW] P/N [pump number] [tacho count] [0/1 (stopped/running)] !

For example: 520Di 15.96 520R 9.6MM 220.0 CW P/N 1 123456789 1 !

Note 2: The correlation between tachometer pulses and motor rotation is fixed and provides a measurable and absolute way of monitoring the number of revolutions of the pump-head - 10,982 pulses per revolution. This in turn allows the count to be equated to the amount of material dispensed - assuming that the pumphead type and tube size are known.

Note 3: If the pump speed is changed subsequently, the pump displays the screen shown here (example figures only) for 4 seconds before reverting to the custom display. 1 to 4 lines of text can be written with ~ as the line delimiter and @ as the message end. i.e., 1W520Di@ and 1W520Di~@ are both valid commands.

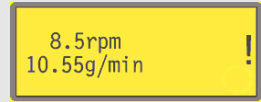

Note 4: In all cases 'n' can be any number from 1 to 64 inclusive, and by exception the # symbol can be used as an all-drives command; but not with the CF, D, PA, PD?, RS, RT, SC, SS or ZY commands, as the results would be indeterminate.

Note 5: The dose parameters are all required, except that SG is only required for dosing by mass, and are variable in length, separated by commas. Missing or illegal characters will cause the command to be aborted and an error message generated on the display. See the table right for an explanation of the expected parameters:

Parameter	Range	Meaning
a	1-9999	Number of doses
b	[A C]	Rotation: counter-clockwise or clockwise
c	0-999	Interval in seconds: eg 1.0
d	0001-3500	Pump speed: tenths of an rpm
e	0-5	Start ramp: scale factor
f	0-5	End ramp: scale factor
g	0.0-1.0	Drip: rev
h	0.001-9999	Dose size: eg 10.00
i	[l m u g kg floz pts gals oz lb]	Dose unit: litres, ml, µl, grams, kg, fluid ounces, pints, gallons, ounces, pounds
j	0.01-15	Specific gravity: eg 1.00

Note 6: No response will be given and the PD? command should be issued to ensure that the command has been accepted. These values will become the current dispense program, as set up in dose mode, overwriting the current values. This command resets the batch count.

Note 7: This command elicits the response 520Di*,#,a,b,c,d,e,f,g,h,i,j ! where the * is the head type and the # is the calibration value in ml/rev. The remaining parameters are defined above.

Note 8: This invokes the response P/N,*,#,a,b,c,d,e,f,g,h,i,j ! for each dose program saved on pump id = n. The format of this string is the 8-character program name (padded with spaces), followed by the normal dose query parameters, without the pump type identifier.

Note 9: The run dose command allows a dose program, set using PD or DO, to be initiated. It also allows the current dispense program, set up in dose mode via the keypad, to be initiated. Normal dose status messages will not be produced; instead a single 'Start' message will be sent back in response, with the following format: P/N [id] [date] [time] Program Started !

For example: P/N 01 08.12.00 11.28.00 Program Started !

On completion of a single dose, the batch count will be incremented by one.

Note 10: If a change speed command is issued while the dose is active the change will not be effected until the current dose is completed.

Note 11: The dose dispensed is a value in the form ***** !
For example: 30.45 !

Note 12: If a value is outside the ±25% rule, an error message is sent back in a string terminated by !. It uses the existing calibration value.

22 Connecting a computer

A computer may be connected to the pump using a nine-pin D-connector wired as shown under Network control and operation. See 21 *Network control and operation*.

Note: Computer output is not available when the pump is under network control.

23 Troubleshooting

If the pump display remains blank when the pump is on, make the following checks:

- Check the position of the voltage selector switch at the rear of the pump.
- Check the mains power switch at the rear of the pump.
- Check that mains power is available to the pump.
- Check the fuse in the fuseholder in the centre of the switchplate at the rear of the pump.
- Check the fuse in the mains power plug if one is present.

If the pump runs but there is little or no flow, make the following checks:

- Check that the tube and rotor are in the pumphead.
- Check that fluid is supplied to the pump.
- Check that the tube is not split or burst.
- Check for any kinks or blockages in the lines.
- Check that any valves in the lines are open.
- Check that the correct wall-thickness tube is being used.
- Check direction of rotation.
- Check that the rotor is not slipping on the drive shaft.

23.1 Error codes

If an internal error occurs, a flashing error screen is displayed.

Note: Signal out of range, Over signal, No signal and Leak detected error screens report the nature of an external signal. They do not flash.

Error condition	Suggested action
RAM write error	Attempt to reset by switching power OFF / ON. Or seek support
RAM corruption	Attempt to reset by switching power OFF / ON. Or seek support
OTP ROM error / corruption	Attempt to reset by switching power OFF / ON. Or seek support
OTP ROM read error	Attempt to reset by switching power OFF / ON. Or seek support
Unknown pump type	Check the interface card and cables. Attempt to reset by switching power OFF / ON. Or seek support
Display failure	Seek support
Wrong key-press	Attempt key-press again. Attempt to reset by switching OFF / ON
Motor stalled	Stop pump immediately. Check pumphead and tube. Power OFF/ON may reset. Or seek support
Tacho fault	Stop pump immediately. Power OFF/ON may reset. Or seek support
Speed error	Stop pump immediately. Power OFF/ON may reset. Or seek support
Over current	Stop pump immediately. Check system. Power OFF/ON may reset. Or seek support*
Over voltage	Stop pump immediately. Check mains voltage selector switch. Check supply. Power OFF/ON may reset. Or seek support
Under voltage	Stop pump immediately. Check mains voltage selector switch. Check supply. ON/OFF may reset. Or seek support
Watchdog error	Attempt to reset by switching power OFF / ON. Or seek support
Over temperature	Stop pump immediately. Turn OFF. Seek support
Leak detected. Check and reset	Remove the cause of any leak. The STOP key resets
Unrecognised key-press	Attempt key-press again. Attempt to reset by switching power OFF/ON. Or seek support
Work overload	Turn OFF. Check power supply. Check pumphead and tubing. Wait 30 minutes. Power ON may reset. Or seek support
Network not detected	Turn OFF. Check network and connections. Or seek support
RS232 fault	Turn OFF. Check network and connections. Or seek support
RS232 lost	Turn OFF. Check network and connections. Or seek support
General error condition	Turn OFF. Seek support

* This problem can occur if the minimum dose size is set (typically one half of a pumphead revolution) and/or a drip reverse is set. In this case, try the following:

- a) Reduce or remove the drip reverse. See 16.1 *16.1: Setting a dispense program*
- b) Increase the dose size. See 16.1 *16.1: Setting a dispense program*
- c) If the dose is fixed, try a smaller tube size, recalibrate the pump and try a longer dose. See 17: *Calibration*

Di, DiN

24 Drive maintenance

There are no user serviceable parts inside the pump (except the power cable: see 10 *Connecting this product to a power supply*). The unit should be returned to Watson-Marlow or its appointed agents or distributors for service.

Di, DiN

25 Drive spares

Replaceable main fuse, type T2,5A H 250V 20mm: FS0064	Foot: MN2507M
(520DiN) Module seal: MN2516B	
(520DiN) Module pcb: MNA2069A	(520DiN) Module switch cover: MN2505M
(520DiN) Glands: GR0056	(520DiN) Blanking plugs: GR0057
(520DiN) Blanking plug and gland sealing washer: GR0058	(520DiN) Snap-fit vent: MN2513B

Di, DiN
Pumphead use is independent of drive ingress protection. No mention of ingress protection rating or drive model (520Di or 520DiN) is made throughout the pumphead sections of this manual.

26 The 505L pumphead

To overcome the pulsatile effect some peristaltic pumps exhibit, Watson-Marlow have developed the principle of twin offset tracks. This puts the two tubes out of phase, merging a pulse from one channel with a trough from the other.

The 505L is fitted with six stainless steel rollers and uses either silicone or Marprene tubing up to 9.6mm bore, 2.4mm wall thickness.

For most dispensing and low pulse applications, use Watson-Marlow double-Y tubing elements, which are pre-formed to the correct length to ensure accurate merging of flows to give the smoothest flow possible.

If you do not wish to use the special double-tube elements, a set of six tube clamps will allow the pumphead to be used with either twin inlet (suction) tubes or as a two channel (totally separate) precision pumphead.

26.1 505L Pumphead fitting and removal



Always isolate the pump from the mains power supply before opening the guard or performing any positioning, removal or maintenance activity.

To fit and remove the pumphead



- Grease the drive shaft tongue. Position the pumphead centrally on the front face of the drive and manually turn the rotor until the slotted rotor shaft engages with the tongue of the drive shaft. Ensure that the two captive retaining bolts align with the top and bottom holes on the drive face.
- Use a 10mm spanner to tighten the retaining bolts to 3Nm.
- Position the adapter cover over the pumphead rear face plate and the captive retaining bolt heads. Click downwards into position.
- Reverse this procedure to remove the track.

To fit an extension pumphead

The front of the 505L pumphead is trimmed with a cover plate held in place with two screws. It must be removed before a second pumphead can be fitted.



- Lift the two levers at either side of the pumphead and remove the track.
- Remove the two screws securing the cover plate to the front of the fixed pumphead. A stubby crosspoint screwdriver may be convenient for this. Remove the cover plate.
- Grease the projecting shaft tongue at the rear of the extension pumphead and the slot at the front of the fixed pumphead. Position the extension pumphead so that the tongue and slot engage, and align the body of the extension pumphead with the body of the first, fixed, pumphead. Fit the two supplied extension pumphead fixing screws at each side of the extension pumphead and tighten. Secure the cover plate to the extension pumphead using the two screws which secured it to the fixed pumphead.
- Position the tracks and secure them by closing the levers.

27 505L tube loading



Always isolate the pump from the mains power supply before removing the track or performing any positioning, removal or maintenance activity.

Tube loading instructions are given for the three possible methods of using a 505L pumphead.

For most dispensing, and any application where there must be minimal pulsing, the use of Watson-Marlow double-Y silicone tubing elements is recommended. These are pre-formed to the correct length and merge two out-of-phase flows into a single smooth output. These elements fit on the bayonet-style retaining pegs supplied with the pumphead.

In certain circumstances it may be useful to run two separate inlet tubes from your source to the pumphead. It is advisable to do this if the fluid is particularly viscous and the single inlet tube is found to restrict the flow rate, or if the pump is situated a long distance from the source reservoir and is running at high speed. A tube clamp set is available from Watson-Marlow (see 30 *505L Pumphead spares*) to securely fix twin inlet tubes.

The 505L may also be used as a two-channel, six-roller, precision pumphead, with two entirely separate tubes. The tube clamp set contains two clamps for each suitable size of tubing to enable both the inlet and the delivery side to be secured. It should be noted that, when used in this way, the flow does not benefit from the smoothing created by combining two out-of-phase flows, and slight channel-to-channel variation may be found in the flow rates. Keeping suction and discharge tubing lengths the same will minimise this variation.

27.1 505L: Fitting double-Y tubing elements

If using a standard element of any size:



- Lift the two levers at either side of the pumphead and remove the track.
- Stretch the tubing element slightly and locate it over the mushroom pegs either side of the pumphead.
- Replace the track and secure it by closing the two levers.

Note: When using Pumpsil 9.6mm elements, best results will be obtained from a High-flow element: part number 913.AH96.K24. Clamp MNA0345A is required to secure the element on the suction side of the pumphead.

If using a 9.6mm High-flow element:



- Lift the two levers at either side of the pumphead and remove the track.
- Remove the mushroom peg on the suction side of the pump by turning it counter-clockwise through one quarter turn and withdrawing it. Do not remove the peg on the delivery side.
- Lay the element across the rotor, with the smaller Y connector over the end peg on the delivery side.
- Tube clamps are marked with the nominal bore for their intended tubing. Pull the element taut and firmly secure it with a 9.6mm clamp on the suction side of the pumphead, using the bayonet-style fixing previously used for the mushroom peg.
- Replace the track and secure it by closing the two levers.

Transfer tubing may now be attached to the connectors. On the suction side, use 12.7mm bore tubing.

27.2 505L: Using twin inlet tubes

Improved flow rates may be obtained by fitting two inlet tubes and using a Y connector to obtain a smooth flow.



- Lift the two levers at either side of the pumphead and remove the track.
- Remove the mushroom peg on the suction side of the pump by turning it counter-clockwise through one quarter turn and withdrawing it. Do not remove the peg on the delivery side.
- Fit two lengths of tube to the top branches of a Y connector. Lay this assembly across the rotor, with the Y connector over the end peg on the delivery side.
- Tube clamps are available, marked with the nominal bore for their intended tubing. Pull the two lengths of tube taut and firmly secure them with a correctly-sized clamp on the suction side of the pumphead, using the bayonet-style fixing previously used for the mushroom peg. You may find it convenient to insert the tubes into the arches of the clamp before securing the clamp.
- Replace the track and secure it by closing the two levers.

Transfer tubing may now be attached to the connectors.

27.3 505L: Using two independent tubes

This option may be used to allow the 520L to function as a twin-channel pumphead.



- Lift the two levers at either side of the pumphead and remove the track.
- Remove the mushroom peg on both sides of the pump by turning it counter-clockwise through one quarter turn and withdrawing it.
- Mark a length of 145mm on two lengths of tube up to a bore size of 8.0mm; or mark a length of 150mm on two lengths of 9.6mm bore tubing.
- Tube clamps are marked with the nominal bore for their intended tubing. Secure the tubes to the suction side of the pumphead with a correctly-sized clamp, aligning one of the marks on each tube with the inner face of the clamp. Secure the clamp by inserting the fixing bayonet into the socket previously used for the mushroom peg and rotating it clockwise one-quarter turn.
- Stretch the tubes slightly and secure them with the second clamp in the same way, with the second pair of marks aligned with the inside of the second clamp. You may find it convenient to insert the tubes into the arches of the second clamp before securing the clamp.
- Replace the track and secure it by closing the two levers.

Note: After fitting new lengths of Marprene tubing, run the pump for about half an hour and then re-tension the tubing, making sure that the nominal lengths above are restored. If tubing lengths greater than those given are used, the tubing may move about within the pumphead and damage will occur.

505L tube clamps

Full set: 059.4001.000

1.6mm bore: MNA0340A 3.2mm bore: MNA0341A

4.8mm bore: MNA0342A 6.4mm bore: MNA0343A

8.0mm bore: MNA0344A 9.6mm bore: MNA0345A

28 505L maintenance



Always isolate the pump from the mains power supply before removing the track or performing any positioning, removal or maintenance activity.

The 505L pumphead is maintenance-free - although it is wise to check the moving parts of the rotor from time to time to ensure that the rotor and its rollers move freely.

If aggressive liquids are spilled on the pumphead, it should be removed and cleaned. Do not use strong solvents.

General guide to cleaning with solvents

Chemical	Cleaning precautions
Aliphatic hydrocarbons	Minimise bearing seals' exposure to less than one minute (risk of attack).
Aromatic hydrocarbons	Minimise bearing seals' exposure to less than one minute (risk of attack).
Ketone solvents	Minimise bearing seals' exposure to less than one minute (risk of attack).
Halogenated/chlorinated solvents	Minimise bearing seals' exposure to less than one minute (risk of attack).
Alcohols, general	No precaution necessary.
Glycols	No precaution necessary.
Ester solvents	Minimise bearing seals' exposure to less than one minute (risk of attack).
Ether solvents	Minimise bearing seals' exposure to less than one minute (risk of attack).

29 505L track adjustment

The track is set for use with 2.4mm wall tubing with bore sizes from 1.6mm to 9.6mm. Do not attempt to change the 14.3mm (0.56in) gap between the track and the top of the pumphead.

30 505L Pumphead spares

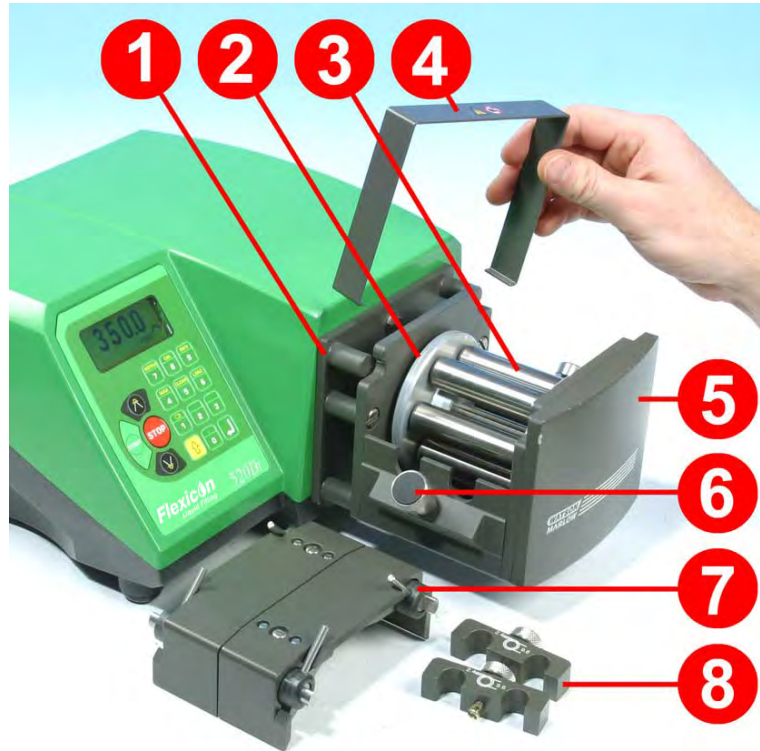

1	MNA0338A	Adaptor plate
2	BB0014	Drive shaft bearing
3	MNA0371A	Rotor assembly
4	MN0862S	Cover plate
5	MN1029C	End plate
6	MNA0339A	Tube-locating mushroom peg (two required)
7	MNA0333A	Track assembly
8	059.4001.000	Tube clamp set: includes two clamps for each of the six tube sizes

31 505L Flow rates

Pumping conditions

All performance figures in this operating instruction have been recorded against peak pipeline pressures.

Flow rates are normalised test values obtained using new tubing, pumping water at 20C with negligible inlet and discharge pressures. Actual flow rates achieved may vary because of changes in temperature, viscosity, inlet and discharge pressures, system configuration and tubing performance against time. Flow rates may also vary due to normal manufacturing tolerances of the tubing. These tolerances will make flow rate variance more pronounced at smaller bore sizes.

For precise and repeatable performance it is important to determine flow rates under operating conditions for each new piece of tubing.



505L pumpheads' flow rates are directly proportional to rotor speed. If you wish to run the pump at a speed not shown in the tables below, flow figures can be reached by dividing the maximum flow shown in the tables below by the maximum rpm figure, and multiplying the result by your required speed in rpm.

505L (ml/min)									
Min	Max	Ratio	Speed range	1.6mm	3.2mm	4.8mm	6.4mm	8.0mm	9.6mm
0.1	350	3500:1	0.1 to 350 rpm	0.04-150	0.23-800	0.42-1500	0.70-2500	0.90-3200	1.3-4400 *

* **Note:** Using 913.AH96.K24 High-flow element.

32 505L Tubing part numbers

2.4mm wall Double Y elements for 505L pumpheads

						
mm	inch	#	Marprene	Bioprene	Pumpsil	
1.6	1/16	119	902.E016.K24	903.E016.K24	913.AE16.K24	
3.2	1/8	120	902.E032.K24	903.E032.K24	913.AE32.K24	
4.8	3/16	15	902.E048.K24	903.E048.K24	913.AE48.K24	
6.4	1/4	24	902.E064.K24	903.E064.K24	913.AE64.K24	
8.0	5/16	121	902.E080.K24	903.E080.K24	913.AE80.K24	
9.6	3/8	122	902.E096.K24	903.E096.K24	913.AE96.K24	
9.6	3/8	122			913.AH96.K24 (High flow)	
mm	inch	#	Chem-Sure	Sta-Pure		
1.6	1/16	119	965.E016.K24	960.E016.K24		
3.2	1/8	120	965.E032.K24	960.E032.K24		
4.8	3/16	15	965.E048.K24	960.E048.K24		
6.4	1/4	24	965.E064.K24	960.E064.K24		
8.0	5/16	121	965.E080.K24	960.E080.K24		

2.4mm wall tubing for 505L pumpheads operating as a twin-channel pump

See 2.4mm wall tubing table in 39 520R and 520R2: Tubing part numbers

Y connectors for 505L pumpheads

Description	Pack of 20
For 1.6mm bore	999.3016.K00
For 3.2mm bore	999.3032.K00
For 4.8mm bore	999.3048.K00
For 6.4mm bore	999.3064.K00
For 8.0mm and 9.6mm bore	999.3096.K00

33 The 520R, 520R2 and 520RE pumpheads

Identification of parts

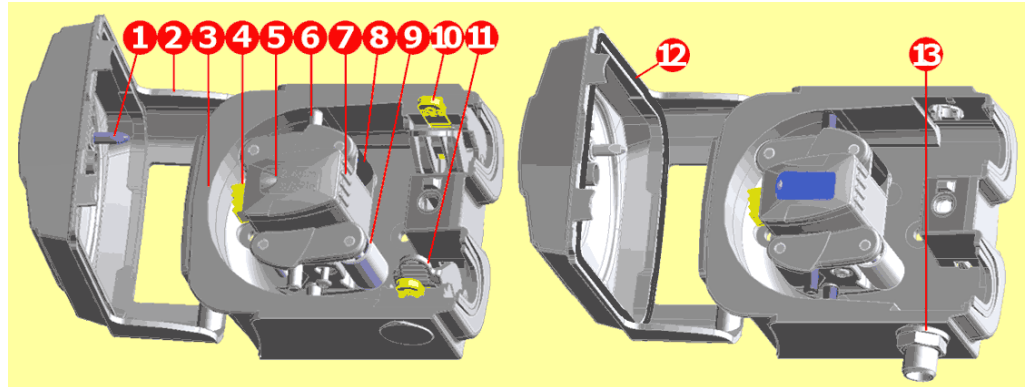

520R/520R2		520REL/520REM/520REH			
1	Guard latch	5	Rotor cap	9	Pumping roller
2	Guard (520R, 520R2)	6	Tube guide roller	10	Tube clamp slider (520R, 520R2)
3	Track	7	Rotor	11	Tube clamp (520R, 520R2)
4	Clutch button cover	8	Follower roller	12	Guard with seal (520RE)
				13	Drain port (520RE)

33.1 Pumphead position, removal and replacement



Always isolate the pump from the mains power supply before removing the track or performing any positioning, removal or maintenance activity.

The pumphead track can be fitted in one of three orientations to provide right, up or down input/output port positions, whichever is convenient. Position the pumphead so that the tube ports face up or down only where the drive is placed on the bench edge - otherwise the pump tube or the hinged guard will impact the bench. Do not position the pumphead so that the tube ports face the keypad. Doing so may result in a safety risk.

The pump can be configured for clockwise or counter-clockwise rotor rotation. Please note, however, that tube life will be greater if the rotor rotates clockwise; and that performance against pressure will be maximised if the rotor rotates counter-clockwise.

To reposition the track

- Open the pumphead guard as described under 27.1 *Opening the pumphead guard*, below.
- Remove the rotor as described under *Rotor removal*, below.



- Undo and withdraw the four track-retaining screws using a slotted screwdriver.
- Remove the track.
- Relocate the track in the desired position. Replace and tighten the track-retaining screws.
- Replace the rotor as described under *Rotor replacement* below.
- Close the guard, pushing it fully home until the latch engages.

Rotor removal

- Remove any tubing from the pumphead.

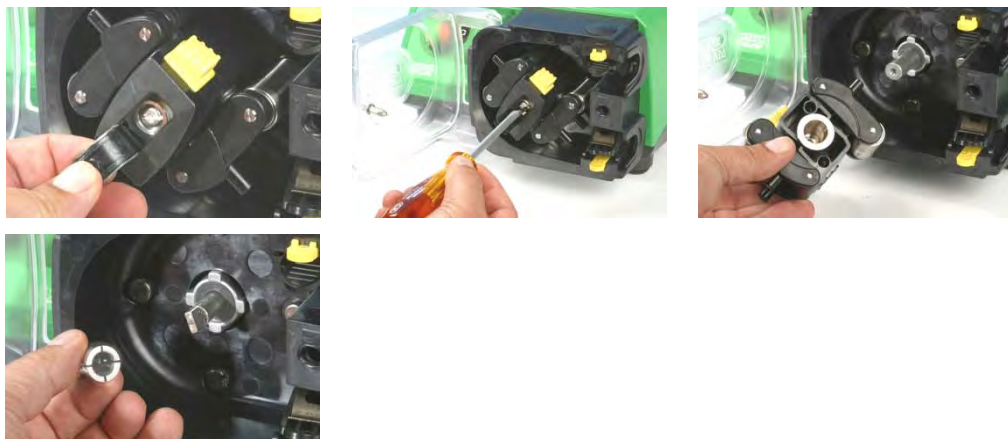

- Open the flexible rotor cap in the centre of the rotor.
- Undo and withdraw the central locating screw using a slotted screwdriver.
- Pull the rotor hub off its dogged shaft.
- Between the hub and the shaft is a split collet. If the collet is retained by the shaft, pull it off, loosening it if necessary by tapping it lightly. Avoid levering it off using a screwdriver or other tool. If the collet is retained within the hub, remove it, loosening it if necessary by reinserting the central locating screw a turn or two and tapping the screw head lightly.

Rotor replacement

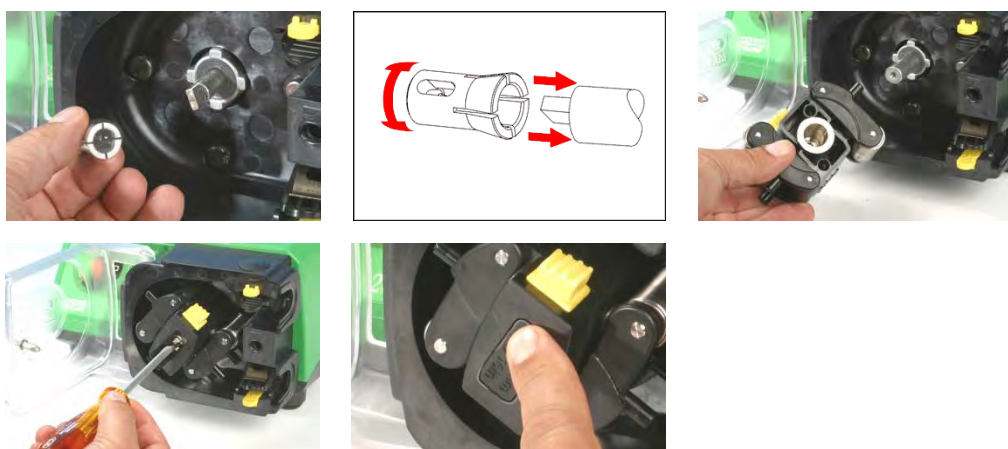

- Re-locate the split collet onto the drive shaft, rotating it until it fully engages the dog. Fit the rotor body over the drive shaft.
- Open the flexible rotor cap in the centre of the rotor. Use a slotted screwdriver to tighten the central locating screw to a torque of 3Nm (2.2 lb-ft) to prevent collet slip during operation. When fitted correctly, the tube guide rollers should align with the outer face of the track. Close the flexible rotor cap.
- Close the guard and ensure that the rotor is clear of the guard by observing the first few rotor rotations.

34 520R, 520R2 and 520RE installation



Always isolate the pump from the mains power supply before opening the guard or performing any positioning, removal or maintenance activity.

34.1 Opening the pumphead guard

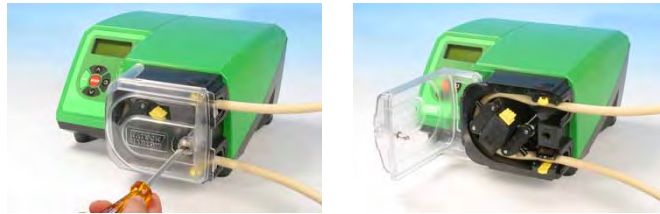

- Unlock the pumphead guard by turning the guard fastener $\frac{1}{4}$ turn anticlockwise with a slotted screwdriver.
- Open the guard to its full extent to create maximum clearance for the tube ports.
- Ensure that the rollers rotate freely and that the tube clamps are clean.

34.2 520R and 520R2 tube loading

520R continuous tubing pumpheads are factory-set to accept Watson-Marlow 1.6mm-wall tubing. 520R2 continuous tubing pumpheads are factory set to accept Watson-Marlow 2.4mm-wall tubing. Pumping performance may be adversely affected if Watson-Marlow tubing is not used.

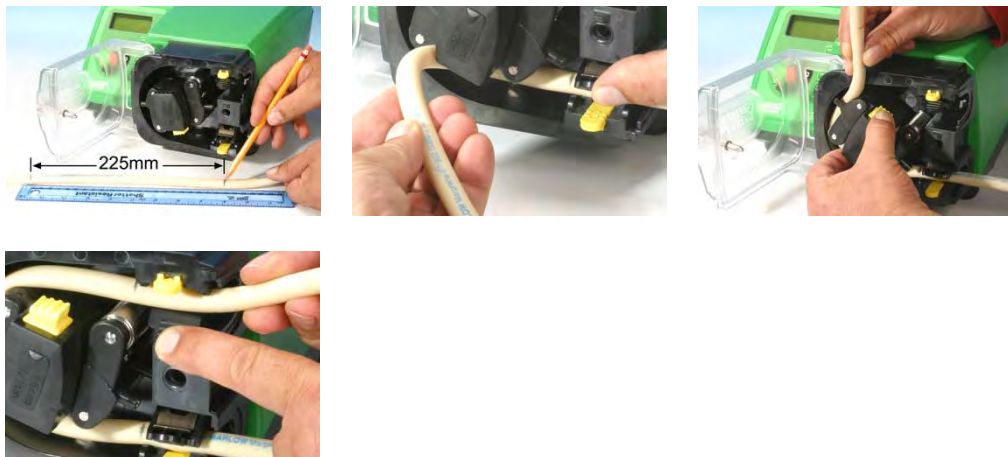

- Mark a 225mm (8 ⁷/₈ in) length onto the section of the tubing which is to be located into the pumphead.
- Open the lower spring-loaded tube clamp and locate the tubing, with the first 225mm (8 ⁷/₈ in) length mark aligned to the inside face of the spring-loaded part of the tube clamp. Release the clamp.
- Disengage the rotor clutch by fully depressing the yellow clutch button on the side of the rotor hub and turning the hub a few degrees while the clutch button is still depressed. The rotor can now rotate independently of the gearbox and motor for one full revolution. If the clutch re-engages before tube fitting is complete, depress the clutch button again and turn the rotor a few degrees.
- Feed the tubing around the pumphead track, turning the rotor as necessary. Make sure the tubing is not twisted or pinched between the guide rollers and the track. Ensure that the second 225mm (8 ⁷/₈ in) mark is adjacent to the inner edge of the upper tube clamp.
- Open the upper spring-loaded tube clamp and locate the tubing into it, making sure there is no residual twist in the tubing, and that the tube sits centrally between the tube guide rollers. Release the clamp.



- The spring-loaded tube clamps must grip the tubing tightly enough to stop it moving in and out of the pumphead but must not over-squeeze the tube and throttle fluid flow. The tubing clamps are fitted with yellow sliders which can be clicked into two positions while the clamps are held open: the outer position will allow the clamps to grip the tube tightly; the inner will grip the tube loosely. Adjust the sliders to prevent tube movement during a few trial rotations of the rotor.
- Close the guard, pushing it fully home until the latch engages.
- Connect suitable pipework to the pumphead tubing using appropriate connectors.
- Remember, when using Marprene or Bioprene tubing, re-tension the tubing after 30 minutes of running, as it may grow in length as it beds in. Re-tension so that 225mm (8 ⁷/₈ in) of tubing sits between the inside faces of the spring-loaded parts of the tube clamps.

34.3 520RE: fitting the drain port

The drain port is an optional extra, supplied with the pumphead. It is strongly recommended that users fit it before the pump is operated. It may be done with the rotor in position or removed.





- Remove the drain plug from the bottom of the pumphead. The drain plug is flexible. It may be removed using finger pressure from within the pumphead, or by accessing its flange from outside with a fingernail.
- Drop the port into position from inside the pumphead.
- Fit the supplied port retaining nut (³/₈ in BSP) and finger-tighten.
- Fit drainage pipework as required (not supplied).

34.4 520RE Element loading

520RE tubing element pumpheads are factory-set to accept Watson-Marlow 2.4mm-wall tubing elements. Elements fitted with either quick-release industrial connectors or Tri-clamp sanitary connectors may be used; however, **it is vital to match the pressure rating of the element with the pressure rating of the pumphead** so that the correct roller-spring rate and occlusion settings are used. The pressure rating of the pumphead appears on the flexible rotor cap in the centre of the rotor. The pressure rating of the element appears on the connector sleeve.

Note that the rotor cap and the element connector sleeve are colour-coded.

Note: To achieve 4 bar and 7 bar pressures using a 520RE pump and the appropriate rotor and element, the pump **must** rotate counter-clockwise.

Element and rotor pressure ratings					
Colour of flexible rotor cap and element connector sleeve					
Grey		Beige		Blue	
					
520REL Pressures up to 2 bar (30 psi) Bore sizes 3.2mm, 6.4mm and 9.6mm		520REM Pressures up to 4 bar (60 psi) Bore sizes 3.2mm and 6.4mm		520REH Pressures up to 7 bar (100 psi) Bore size 3.2mm	
Industrial Marprene TL Pumpsil Neoprene Chem-Sure	Sanitary Bioprene TL Pumpsil Sta-Pure Chem-Sure	Industrial Marprene TM Chem-Sure	Sanitary Bioprene TM Sta-Pure	Industrial Marprene TH Sta-Pure	Sanitary Bioprene TH Sta-Pure

Element connectors for industrial and sanitary use	
Industrial	Sanitary
	



Check that the conical connector sleeve of the element to be fitted is the same colour as the pumphead rotor cap

520RE element loading procedure

Note: The element loading procedure is the same for industrial (pictured) and sanitary elements.

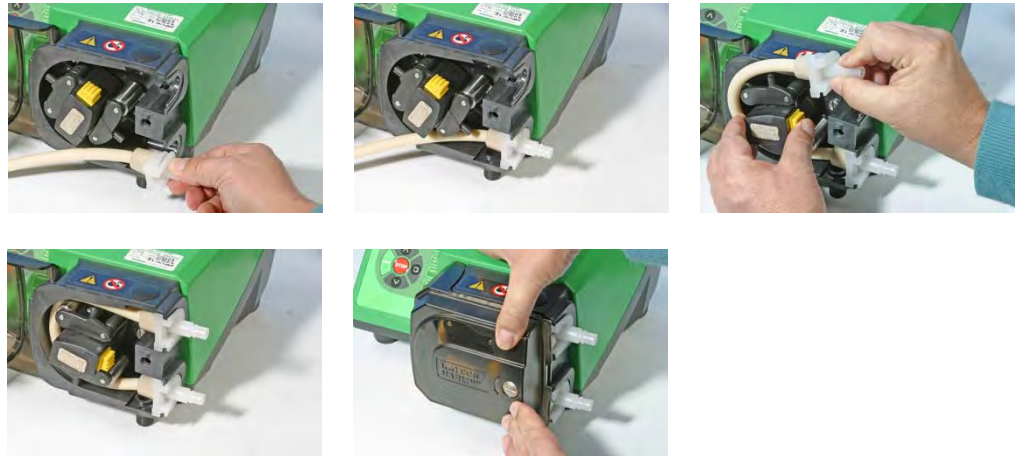

- Select an appropriate Watson-Marlow 520RE tubing element, paying attention to pressure capability, bore size, tubing material and type of connector. See the table above for pressure ratings. **Check that the connector sleeve of the element to be fitted is the same colour as the pumphead rotor cap.**
- Slide the connector D-flange at one end of the element into the lower connector D-slot.
- Disengage the rotor clutch by fully depressing the yellow clutch button on the side of the rotor hub and turning the hub a few degrees while the clutch button is still depressed. The rotor can now rotate independently of the gearbox and motor for one full revolution. If the clutch re-engages before tube fitting is complete, depress the clutch button again and turn the rotor a few degrees.
- Feed the tubing element around the pumphead track, turning the rotor as necessary. Make sure the tubing is not twisted or pinched between the guide rollers and the track.
- Slide the second connector D-flange into the upper connector D-slot.
- Check that the element lies in the middle of the track and that the connector flanges are pushed fully home.
- Close the guard, pushing it fully home until the latch engages.
- Connect suitable pipework to the pumphead tubing using appropriate connectors. See below.

34.5 520RE Element connection

Select suitable tubing to connect to the tubing element supply and discharge connectors. Check that its pressure rating is appropriate to the application.

Sanitary $\frac{3}{4}$ in mini-Tri-clamp connectors

Sanitary connectors are connected to a tubing system using mini-Tri-clamps and gaskets.



- Hold the connector end of the supply or discharge tube against the element connector, with a gasket between them.
- Use a Tri-clamp to engage both flanges squarely, close it and tighten.

Industrial quick-release connectors

Industrial connectors are connected to a tubing system using quick-release fittings.



- Hold the pump securely and push the female fitting (available from Watson-Marlow) over the element until it clicks into place.



- To disconnect, hold the pump securely and pull the connector outer sleeve and twist counter-clockwise while pulling the female connector away.

35 520R, 520R2 and 520RE maintenance



Always isolate the pump from the mains power supply before opening the guard or performing any positioning, removal or maintenance activity.

- As part of regular cleaning and maintenance (and at least every three months), lubricate the pivot points, the follower rollers and the tube guide rollers with Ultra Lube (PA 1240), which is a non-toxic perfluoroether-based grease.
- The stainless steel pumping rollers run on externally-sealed bearings and are lubricated for life.
- Check that the pumphead track, rotor, rollers and spring-loaded tube clamps (if fitted) are clean and operating properly.
- If fluid is spilled inside the pumphead it should be cleaned as soon as possible, as reducing exposure time to contamination will prolong pumphead service life.
- To clean the pumphead, remove the rotor as described under *Rotor removal*, above. Flush the pumphead out with water and mild detergent, or suitable cleaning agent. Clean the rotor and rollers in the same way. If specific cleaning agents are required to clean the spillage, consult the general guide to cleaning with solvents below or Watson-Marlow after-sales office before proceeding, in order to confirm chemical compatibility. **Note:** the pumphead guard, rotor cap and clutch boot should be removed in advance of some cleaning regimes. See the table below. These components are available as spares if damaged.
- Replace the rotor as described under *Rotor replacement*, above.

General guide to cleaning with solvents

Chemical	Cleaning precautions
Aliphatic hydrocarbons	Remove guard. Minimize rotor cap and clutch boot exposure to less than one minute (risk of attack). Re-lubricate follower and tube guide rollers.
Aromatic hydrocarbons	Remove guard. Minimize rotor cap and clutch boot exposure to less than one minute (risk of attack). Re-lubricate follower and tube guide rollers.
Ketone solvents	Remove guard. Minimize rotor cap and clutch boot exposure to less than one minute (risk of attack). Re-lubricate follower and tube guide rollers.
Halogenated/chlorinated solvents	Not recommended: possible risk to polycarbonate tube clamp adjusters and polypropylene tube clamp locators.
Alcohols, general	No precaution necessary. Re-lubricate follower and tube guide rollers.
Glycols	Minimize rotor cap and clutch boot exposure to less than one minute (risk of attack). Re-lubricate follower and tube guide rollers.
Ester solvents	Remove guard. Minimize rotor cap and tube clamp location cap exposure to less than one minute (risk of attack). Re-lubricate follower and tube guide rollers.
Ether solvents	Not recommended: possible risk to polycarbonate tube clamp adjusters and polypropylene tube clamp locators.

36 520R, 520R2 and 520RE rotor settings

520R, 520R2 and 520RE pumpheads are factory-set to give optimum tube life with Watson-Marlow tubing and elements. Radial roller positions should not be adjusted in any circumstances as this will adversely affect pumphead performance and invalidate warranty. Tamper-proof rotor arm occlusion setting screws are fitted to warn operators from occlusion adjustment. Tubing with a wall thickness other than 1.6mm or 2.4mm can be used only with a pumphead set up for that purpose during manufacture. Contact Watson-Marlow after-sales.

37 Pumphead spares

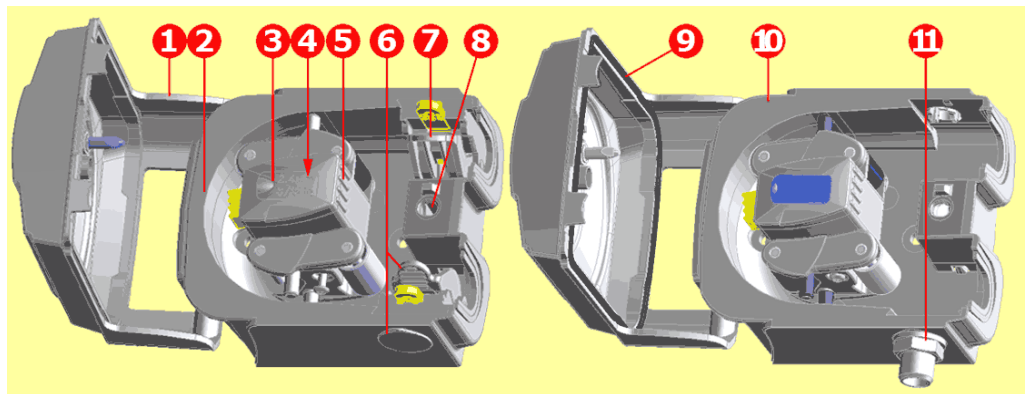

520R/520R2

520REL/520REM/520REH

053.1011.100	520R
053.1011.2L0	520R2
053.1011.EL0	520REL
053.1011.EM0	520REM
053.1011.EH0	520REH
1 MNA2050A (520R, 520R2)	Pumphead guard complete with tool-unlockable latch
2 MNA2045A (520R, 520R2)	Track assembly for cased pumps complete with spring-loaded tube clamps
3 MNA2076A (520R - 1.6mm wall tube) MNA2077A (520R2 - 2.4mm wall tube) MNA2148A (grey) (520REL) MNA2149A (beige) (520REM) MNA2150A (blue) (520REH)	Rotor cover, rotor cap and clutch button
4 MN2011M S60022	Clutch Clutch spring
5 MNA2043A (520R - 1.6mm wall tube) MNA2001A (520R2 - 2.4mm wall tube) MNA2138A (520REL - 0-2 bar, 0-30 psi) MNA2139A (520REM - 2-4 bar, 30-60 psi) MNA2140A (520REH - 4-7 bar, 60-100 psi)	Rotor assembly complete with pumping rollers, follower rollers and tube guide rollers
6 MNA2006A (520R, 520R2) MN2002M (520R, 520R2) MN2131M (520RE)	Bottom (LH) tube clamp Tube clamp location plug Drain plug
7 MNA2005A (520R, 520R2) MN2002M (520R, 520R2)	Top (RH) tube clamp Tube clamp location plug
8 MN2034B MN2005M	Guard latch spring Guard latch spring cartridge
9 MNA2147A (520RE)	Pumphead guard complete with seal and tool-unlockable latch
10 MNA2144A (520RE)	Track assembly for cased pumps
11 MN2023T and MN2003T (520RE)	Drain port and nut

Parts may be ordered individually.

38 Flow rates

Pumping conditions

For precise and repeatable performance it is important to determine flow rates under operating conditions for each new piece of tubing.

When rotating counter-clockwise, 520R, 520R2 and 520RE pumpheads' flow rates are directly proportional to rotor speed. When rotating clockwise, 520R, 520R2 and 520RE pumpheads' flow rates are directly proportional to rotor speed up to 1.5 bar; their performance above 1.5 bar should be determined empirically.

Note: 520RE pumpheads should be used rotating counter-clockwise if pressures above 1.5 bar are required.

If you wish to run the pump at a speed not shown in the tables below, flow figures can be reached by dividing the maximum flow shown in the tables below by the maximum rpm figure, and multiplying the result by your required speed in rpm.

Actual flow rates achieved may vary because of changes in temperature, viscosity, inlet and discharge pressures, system configuration and tubing performance against time. Flow rates may also vary due to normal manufacturing tolerances of the tubing. These tolerances will make flow rate variance more pronounced at smaller bore sizes.

520R and 520R2

All performance figures for the 520R and 520R2 pumpheads have been recorded against peak pipeline pressures.

Although rated to 2bar (30psi) peak pressure, this pump will generate in excess of 2bar (30psi) peak pressure if the pipeline is restricted. Where it is important that 2bar (30psi) is not exceeded, pressure relief valves should be installed in the pipeline.

Viscosity handling is maximised by using 2.4mm wall tubing with the 520R2 pump-head.

Flow rates are normalised test values obtained using 225mm (8 ⁷/₈) of new tubing (measured from the inside faces of the tube clamps), and the pumphead rotating clockwise pumping water at 20C with negligible inlet and discharge pressures.

Note: Flow rates quoted are for 1.6mm and 2.4mm wall tubes. Tubes of 0.5mm and 0.8mm bore are only available in 1.6mm wall thickness except for platinum-cured silicone. Tubes of 9.6mm bore are only available in 2.4mm wall thickness.

520RE

Performance figures for the 520REL and 520REM have been recorded against 2bar peak pressure and 4bar peak pressure respectively.

Performance figures for the 520REH have been recorded against 7bar constant pressure.

Although the 520REL is rated to 2bar (30psi) peak pressure, the 520REM is rated to 4bar (60psi) peak pressure and the 520REH is rated to 7bar (100psi) constant pressure, the pumps will generate in excess of these pressures if the system pressures exceed this. Where it is important that these rated pressures are not exceeded, pressure relief valves should be installed in the pipeline.

Flow rates are normalised test values obtained using 520 elements and the pump-head rotating anticlockwise pumping water at 20C with negligible inlet and discharge pressures.

Continuous tubing

520R Neoprene, Sta-Pure, Chem-Sure, PVC, Pumpsil (ml/min)								
Speed range	0.5mm	0.8mm	1.6mm	3.2mm	4.8mm	6.4mm	8.0mm	9.6mm
520Di/R,520Di/R2,520DiN/R,520DiN/R2								
0.1-300rpm	0.004-13	0.01-33	0.04-130	0.18-530	0.40-1200	0.70-2100	1.1-3300	1.6-4800

520R Marprene / Bioprene 64 shore tubing (ml/min)								
Speed range	0.5mm	0.8mm	1.6mm	3.2mm	4.8mm	6.4mm	8.0mm	9.6mm
520Di/R,520Di/R2,520DiN/R,520DiN/R2								
0.1-300rpm	0.004-12	0.01-32	0.04-130	0.17-500	0.38-1100	0.67-2000	1.1-3200	1.5-4500

520R Fluorel (ml/min)					
Speed range	1.6mm	3.2mm	4.8mm	6.4mm	8.0mm
520Di/R,520Di/R2,520DiN/R,520DiN/R2					
0.1-300rpm	0.03-96	0.13-380	0.29-860	0.51-1500	0.80-2400

520R Neoprene, Sta-Pure, Chem-Sure, PVC, Pumpsil (USGPH)								
Speed range	0.5mm	0.8mm	1.6mm	3.2mm	4.8mm	6.4mm	8.0mm	9.6mm
520Di/R,520Di/R2,520DiN/R,520DiN/R2								
0.1-300rpm	0.0001-0.20	0.0002-0.52	0.001-2.1	0.003-8.4	0.006-19	0.01-33	0.02-52	0.03-75

520R Marprene / Bioprene 64 shore tubing (USGPH)								
Speed range	0.5mm	0.8mm	1.6mm	3.2mm	4.8mm	6.4mm	8.0mm	9.6mm
520Di/R,520Di/R2,520DiN/R,520DiN/R2								
0.1-300rpm	0.0001-0.20	0.0002-0.50	0.001-2.0	0.003-8.0	0.01-18	0.01-32	0.02-50	0.02-72

520R Fluorel (USGPH)					
Speed range	1.6mm	3.2mm	4.8mm	6.4mm	8.0mm
520Di/R,520Di/R2,520DiN/R,520DiN/R2					
0.1-300rpm	0.0005-1.5	0.002-6.1	0.005-14	0.01-24	0.01-38

Elements

520REL Neoprene, Sta-Pure, Chem-Sure, Pumpsil (ml/min)				520REL Marprene / Bioprene TL (ml/min)		
Speed range	3.2mm	6.4mm	9.6mm	3.2mm	6.4mm	9.6mm
520Di/REL, 520DiN/REL						
0.1-300rpm	0.18-530	0.70-2100	1.6-4800	0.17-500	0.67-2000	1.5-4500

520REL Neoprene, Sta-Pure, Chem-Sure, Pumpsil (USGPH)				520REL Marprene / Bioprene TL (USGPH)		
Speed range	3.2mm	6.4mm	9.6mm	3.2mm	6.4mm	9.6mm
520Di/REL, 520DiN/REL						
0.1-300rpm	0.003-8.4	0.01-33	0.03-75	0.003-8.0	0.01-32	0.02-72

520REM Sta-Pure, Chem-Sure (ml/min)			520REM Marprene / Bioprene TM (ml/min)	
Speed range	3.2mm	6.4mm	3.2mm	6.4mm
520Di/REM, 520DiN/REM				
0.1-300rpm	0.18-530	0.70-2100	0.17-500	0.67-2000

520REM Sta-Pure, Chem-Sure (USGPH)			520REM Marprene / Bioprene TM (USGPH)	
Speed range	3.2mm	6.4mm	3.2mm	6.4mm
520Di/REM, 520DiN/REM				
0.1-300rpm	0.003-8.4	0.01-33	0.003-8.0	0.01-32

520REH Marprene / Bioprene TH, Sta-Pure (ml/min)		520REH Marprene / Bioprene TH, Sta-Pure (USGPH)	
Speed range	3.2mm	3.2mm	
520Di/REH, 520DiN/REH			
0.1-300rpm	0.20-610	0.003-9.7	

Performance curves

Marprene continuous tubing, 1.6mm wall, 200rpm, clockwise rotation

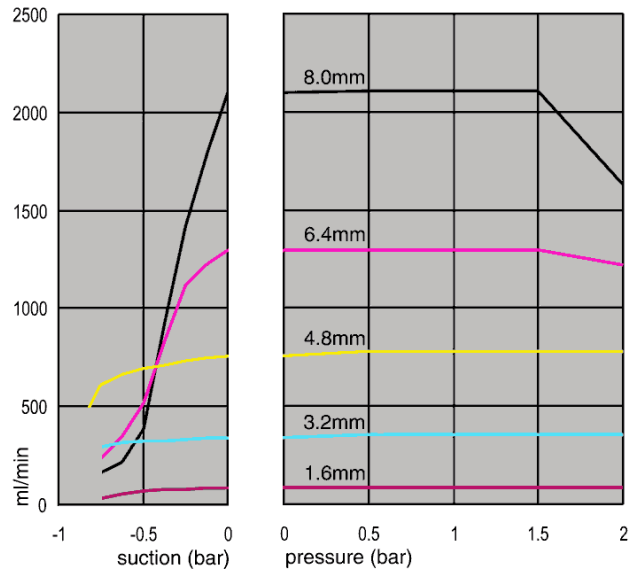

Marprene continuous tubing, 1.6mm wall, 200rpm, counter-clockwise rotation

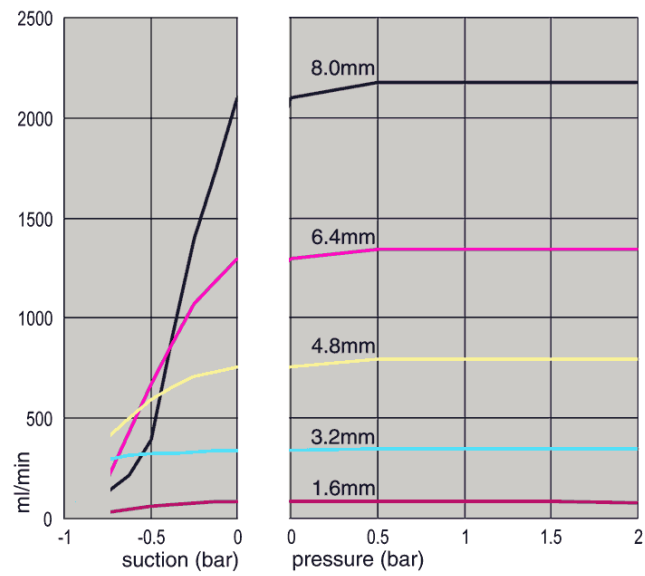

Marprene continuous tubing, 2.4mm wall, 200rpm, clockwise rotation

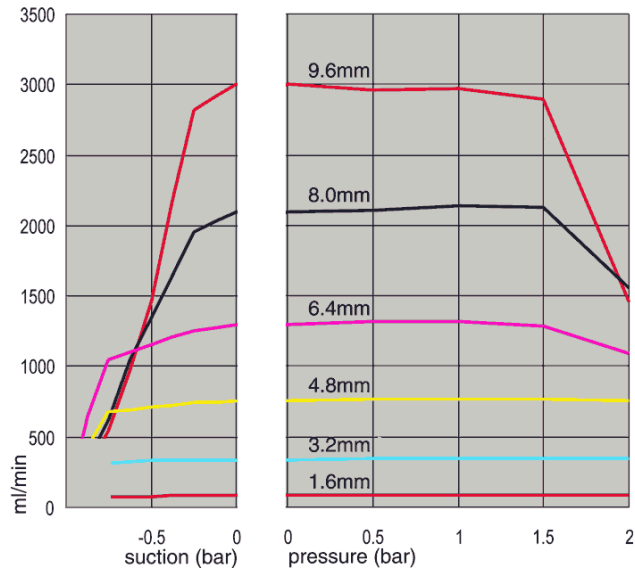

Marprene continuous tubing, 2.4mm wall, 200rpm, counter-clockwise rotation

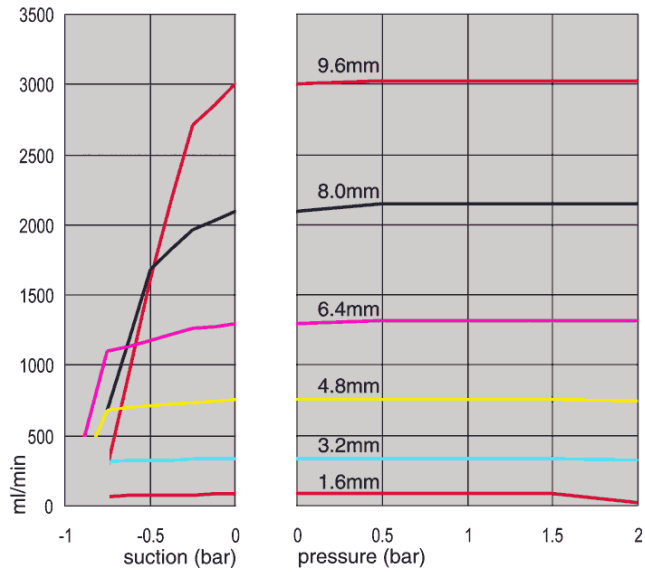

Marprene TL element, 0-2 bar (0-30psi), 200rpm, counter-clockwise rotation

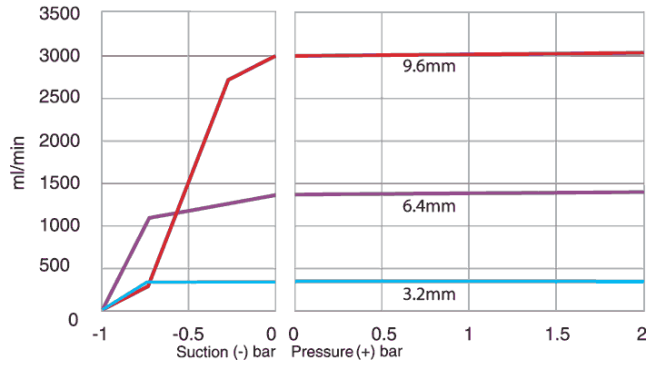

Sta-Pure element, 0-2 bar (0-30psi), 200rpm, counter-clockwise rotation

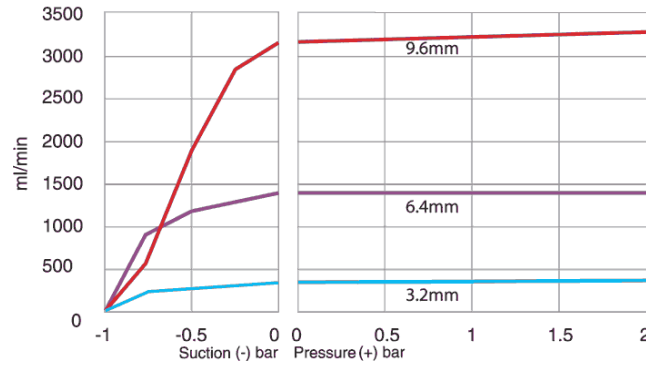

Marprene TM element, 2-4 bar (30-60psi), 200rpm, counter-clockwise rotation

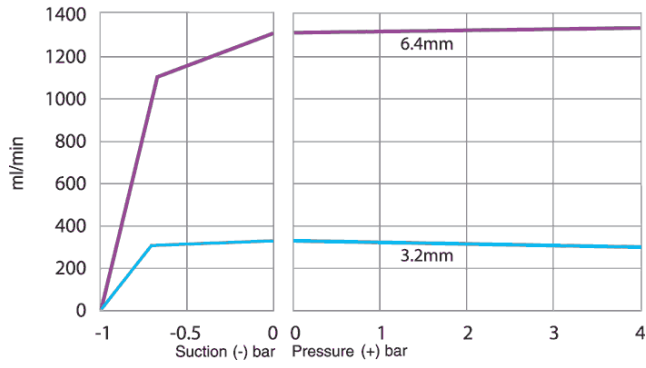

Sta-Pure element, 2-4 bar (30-60psi), 200rpm, counter-clockwise rotation

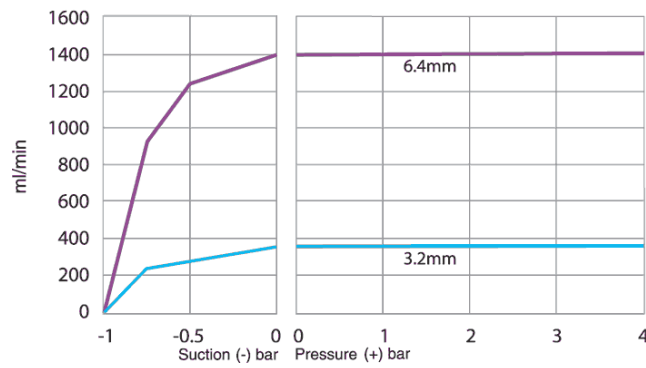

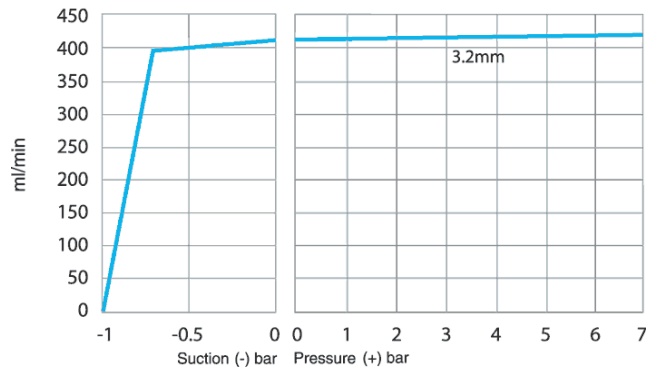

Marprene TH element, 4-7 bar (60-100psi), 200rpm, counter-clockwise rotation





39 Tubing and element part numbers

1.6mm wall tubing for 520R pumpheads

					
mm	inch	#	Marprene	Bioprene	Chem-Sure
0.5	1/50	112	902.0005.016	903.0005.016	
0.8	1/32	13	902.0008.016	903.0008.016	
1.6	1/16	14	902.0016.016	903.0016.016	965.0016.016
3.2	1/8	16	902.0032.016	903.0032.016	965.0032.016
4.8	3/16	25	902.0048.016	903.0048.016	965.0048.016
6.4	1/4	17	902.0064.016	903.0064.016	965.0064.016
8.0	5/16	18	902.0080.016	903.0080.016	965.0080.016
mm	inch	#	PVC	Fluorel	Neoprene
0.8	1/32	13			920.0008.016
1.6	1/16	14	950.0016.016	970.0016.016	920.0016.016
3.2	1/8	16	950.0032.016	970.0032.016	920.0032.016
4.8	3/16	25	950.0048.016	970.0048.016	920.0048.016
6.4	1/4	17	950.0064.016	970.0064.016	920.0064.016
8.0	5/16	18	950.0080.016	970.0080.016	920.0080.016
mm	inch	#	Pumpsil	Sta-Pure	
0.5	1/50	112	913.A005.016		
0.8	1/32	13	913.A008.016		
1.6	1/16	14	913.A016.016	960.0016.016	
3.2	1/8	16	913.A032.016	960.0032.016	
4.8	3/16	25	913.A048.016	960.0048.016	
6.4	1/4	17	913.A064.016	960.0064.016	
8.0	5/16	18	913.A080.016	960.0080.016	

Note: 1.6mm wall Chem-Sure and Sta-Pure tubing are supplied in 305mm lengths.

2.4mm wall tubing for 520R2 pumpheads

					
mm	inch	#	Marprene	Bioprene	Pumpsil
0.5	1/50				913.A005.024
0.8	1/32				913.A008.024
1.6	1/16	119	902.0016.024	903.0016.024	913.A016.024
3.2	1/8	120	902.0032.024	903.0032.024	913.A032.024
4.8	3/16	15	902.0048.024	903.0048.024	913.A048.024
6.4	1/4	24	902.0064.024	903.0064.024	913.A064.024
8.0	5/16	121	902.0080.024	903.0080.024	913.A080.024
9.6	3/8	122	902.0096.024	903.0096.024	913.A096.024
mm	inch	#	Chem-Sure	Sta-Pure	
1.6	1/16	119	965.0016.024	960.0016.024	
3.2	1/8	120	965.0032.024	960.0032.024	
4.8	3/16	15	965.0048.024	960.0048.024	
6.4	1/4	24	965.0064.024	960.0064.024	
8.0	5/16	121	965.0080.024	960.0080.024	
<i>Note: 2.4mm wall Chem-Sure and Sta-Pure tubing are supplied in 355mm lengths.</i>					

2.4mm wall elements for 520RE pumpheads

0-2 bar (0-30 psi) pressure rated elements



Industrial

mm	inch	#	Marpren TL	Pumpsil	Neoprene	Chem-Sure
3.2	1/8	16	902.0032.PFQ	913.A032.PFQ	920.0032.PFQ	965.0032.PFQ
6.4	1/4	17	902.0064.PFQ	913.A064.PFQ	920.0064.PFQ	965.0064.PFQ
9.6	3/8	122	902.0096.PFQ	913.A096.PFQ	920.0096.PFQ	965.0096.PFQ

Sanitary

mm	inch	#	Bioprene TL	Pumpsil	Sta-Pure	Chem-Sure
3.2	1/8	16	903.0032.PFT	913.A032.PFT	960.0032.PFT	965.0032.PFT
6.4	1/4	17	903.0064.PFT	913.A064.PFT	960.0064.PFT	965.0064.PFT
9.6	3/8	122	903.0096.PFT	913.A096.PFT	960.0096.PFT	965.0096.PFT

2-4 bar (30-60 psi) pressure rated elements



Industrial

mm	inch	#	Marpren TM	Chem-Sure
3.2	1/8	16	902.P032.PFQ	965.M032.PFQ
6.4	1/4	17	902.P064.PFQ	965.M064.PFQ

Sanitary

mm	inch	#	Biopren TM	Sta-Pure
3.2	1/8	16	903.P032.PFT	960.M032.PFT
6.4	1/4	17	903.P064.PFT	960.M064.PFT

4-7 bar (60-100 psi) pressure rated elements



Industrial

mm	inch	#	Marpren TM	Sta-Pure
3.2	1/8	16	902.H032.PFQ	960.H032.PFQ

Sanitary

mm	inch	#	Biopren TM	Sta-Pure
3.2	1/8	16	903.H032.PFT	960.H032.PFT

40 520 series pumping accessories

Accessory	Description	Part code	Pump compatibility
520ANC	Network cable, RS232, with 9-pin D-connectors	059.3121.000	520Du, 520Di
520ANX	Network extension cable with 9-pin D-connectors	059.3122.000	520Du, 520Di
520ANA	Network adaptor, 25-pin to 9-pin D-connectors	059.3123.000	
520AB	Batch records cable with 9-pin D-connectors	059.3125.000	520Di
520AF	Footswitch with 25-pin D-connector	059.3002.000	520U, 520Du, 520Di
520AH	Handswitch with 25-pin D-connector	059.3022.000	520U, 520Du, 520Di
520AV	Proximity switch	059.5072.000	520Di
520AVN	Proximity switch	059.507N.000	520DiN
505LTC	Tube clamp set for 505L pumphead	059.4001.000	520Di
505AS	Filling stand	059.5001.000	All models
520AL	Dispensing lance for use with 520AFN filling needles	059.5052.000	All models
505AFN	Filling needle set	059.5101.000	All models
	Filling needle 1.6mm bore	059.5100.016	All models
	Filling needle 3.2mm bore	059.5100.032	All models
	Filling needle 4.8mm bore	059.5100.048	All models
	Filling needle 6.4mm bore	059.5100.064	All models
	Filling needle 8.0mm bore	059.5100.080	All models
	Tube monitor with 25-pin D-connector	059.4501.520	520U, 520Du, 520Di
	Tube monitor, bare lead	059.450N.520	520UN, 520DuN, 520DiN
520AD	Leak detector kit	059.8121.000	520U, 520Du, 520Di
520AD	Leak detector kit	059.8131.000	520UN, 520DuN, 520DiN

Di, DiN

41 Trademarks

Watson-Marlow, Bioprene, Pumpsil, LoadSure and **Marprene** are trademarks of Watson-Marlow Limited.

Fluorel is a trademark of 3M.

Sta-Pure and **Chem-Sure** are trademarks of W.L.Gore and Associates.

Di, DiN

42 Warning not to use pumps in patient-connected applications

Warning: These products are not designed for use in, and should not be used for patient-connected applications.

Di, DiN

43 Publication history

m-520di-din-gb-06.qxp: Flexicon 520Di IP31; 520DiN IP66 NEMA 4X
First published 03 05. Revised 09 06. Revised 01 08. Revised 01 09.
Revised 03 13.

44 Decontamination certificate

In compliance with the *UK Health and Safety at Work Act* and the *Control of Substances Hazardous to Health Regulations*, you are required to declare the substances which have been in contact with product(s) you return to Watson-Marlow or its subsidiaries or distributors. Failure to do so will cause delays. Please ensure that you fax us this form and receive an RGA (Returned Goods Authorisation) before you despatch the product(s). A copy of this form must be attached to the outside of the packaging containing the product(s). Please complete a separate decontamination certificate for each product.

You are responsible for cleaning and decontaminating the product(s) before return.

Your name	<input type="text"/>	Company	<input type="text"/>
Address	<input type="text"/>		
Postcode/zip	<input type="text"/>	Country	<input type="text"/>
Telephone	<input type="text"/>	Fax	<input type="text"/>
Product type	<input type="text"/>	Serial number	<input type="text"/>
To speed the repair, please describe all known faults	<input type="text"/>		
The product has ...	<input type="checkbox"/> Been used <input type="checkbox"/> Not been used		
	<i>If the product has been used, please complete all the following sections. If the product has not been used, please just sign this form.</i>		
Names of chemicals handled with product(s)	<input type="text"/>		
Precautions to be taken in handling these chemicals	<input type="text"/>		
Action to be taken in the event of human contact	<input type="text"/>		
	<i>I understand that the personal data collected will be kept confidentially in accordance with the UK Data Protection Act 1998.</i>		
Signature	<input type="text"/>	RGA number	<input type="text"/>
		Your position	<input type="text"/>
		Date	<input type="text"/>
<i>Please print out, sign and fax to Watson-Marlow Pumps at +44 1326 376009.</i>			