

## FF30

(Example; exact model may vary)

*This instruction handbook is for the daily users of the equipment.*

## Table of Contents

1	Introduction .....	4
1.1	FF30 .....	4
1.2	Abbreviations in this manual .....	4
1.3	Symbols on the machine .....	4
1.4	Caution and employee safety .....	5
1.5	Essential training before daily use .....	5
1.6	References .....	5
1.7	Dismantling and disposal .....	5
2	General information.....	6
2.1	Unpacking and inspection .....	6
2.2	Storing the FF30 .....	6
2.3	Mounting of support for inlet and outlet tray .....	6
2.4	Technical specifications .....	8
2.4.1	Dimensions .....	8
2.4.2	Buttons / Control panel.....	9
2.4.3	Services .....	10
2.4.4	Bottles, caps and trays.....	10
2.4.5	Ingress protection .....	10
2.4.6	Weight.....	10
2.4.7	Materials of construction .....	10
2.4.8	Fillers .....	11
3	Installation.....	11
3.1	Connections.....	11
3.2	Mounting of format parts .....	12
3.2.1	Bottle format parts.....	12
3.2.2	Screw cap format parts .....	14
4	Daily Use .....	16
4.1	Starting-up and running.....	16
4.1.1	Adjusting the round table inner bottle guide .....	16
4.1.2	Adjusting the inlet guide .....	16
4.1.3	Installing Inner bottle guide flexible tip.....	17
4.1.4	Adjustment of the filling stand .....	18
4.2	Adjusting the capping sensor .....	18
4.3	Adjusting the height of capping head .....	19
4.4	Adjusting the capping torque.....	19
4.5	Adjustments .....	20
4.5.1	Index speed adjustment .....	20
4.5.2	Bottle ejector speed adjustment .....	20
4.5.3	Capping time adjustment.....	20
4.5.4	Round table speed adjustment.....	20
4.6	Production START and STOP .....	21
4.6.1	Manual placing of caps .....	21
4.6.2	Removing bottles from collection tray.....	21
4.7	Stepping bottles through the FF30 .....	21
5	Malfunctioning.....	22
5.1	Start-up alarms .....	22
5.2	Runtime alarms.....	22
5.3	Runtime warnings .....	24
5.4	Trouble shooting .....	24
6	Cleaning.....	25
6.1	Cleaning Frequency .....	25
6.2	Preparations for cleaning .....	25
6.3	Cleaning Guidance.....	25

6.4	Detergents or cleaning agents .....	25
7	Maintenance & service .....	26
7.1	Maintenance.....	26
7.1.1	Tension of toothed belt .....	26
7.1.2	Capping unit .....	27
7.1.3	Star wheel and bottle ejector .....	27
7.2	Service .....	28
7.2.1	Safety coupling.....	28
7.3	Methods and frequency of inspections for safety functions .....	28
8	Change of voltage .....	29

## 1 Introduction

All the photographs in this handbook are photo examples and may vary slightly from the exact model; i.e. type of bottle used on the photograph, type of guiding on the inlet and outlet trays etc.

### 1.1 FF30

FF30 is a small-scale bottle handling, filling and capping machine.

A round table moves the bottles to the inlet, from which each bottle is moved further on by a star wheel.

Filling is performed automatically, and capping is semi-automatic.

After capping the bottle is pushed to the outlet tray by a bottle ejector.

FF30 is delivered without the external filler; in order to perform the filling, a filler must be connected. (See further information in section 2.4)

### 1.2 Abbreviations in this manual

App.	Approximately
A/R	Alarm / Reset
e.g.	As example
BPM	Bottles per minute
Fig.	Figure
Hz	Hertz
IH	Instruction Handbook
L/min	Litres per minute
Max.	Maximum
mA	milliampere
msec	milliseconds
PE	Protective Earth (electrical units safety measure)
RT	Round Table
VAC	Volt Alternating Current
VDC	Volts Direct Current
WMF	Watson-Marlow Flexicon a/s

### 1.3 Symbols on the machine

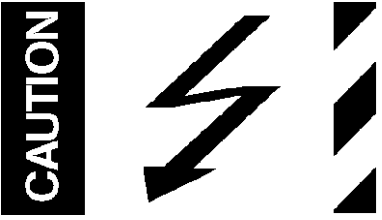
Warning against touching	Warning against high voltage
	

### **1.4 Caution and employee safety**

This manual should be read before using the FF30.

It is strongly advised that

- Any kind of maintenance or cleaning of the machine not is carried out while power is connected.
- Unauthorised / non-trained personnel should not open the cover of the electrical parts.
- The machine is placed in such a way that it is not exposed to high humidity, high temperatures or other abnormal operating environment.
- The machine is not to be used in explosion hazardous environments.

### **1.5 Essential training before daily use**

Read the section with *Daily Use*, thoroughly before using the machine.

Protective equipment and protective devices are installed:

- If the star wheel is jammed it will stop immediately
- The capping machine will stop if it is unable to reach lower position during capping; e.g. this way fingers or instruments will not be squeezed if they are placed between the cap and the capping head during production.

Always respect the symbols on the machine.

Cleaning must be performed as described in this IH.

### **1.6 References**

N/A

### **1.7 Dismantling and disposal**

Prior to dismantling, it must be observed that all services are disconnected, and fixing to other equipment is removed.

WM-Flexicon machines may not be disposed using normal refuse collection. The machines must be collected and disposed separately as they contain electrical components such as batteries, electrolyte capacitors, liquid crystal displays and printed circuit boards.

Further information is available on [www.wmftg.com](http://www.wmftg.com).

\* (WEEE) DS/EN 50419



## 2 General information

### 2.1 Unpacking and inspection

Before unpacking the FF30 it should be checked if the crate is damaged. When unpacking remove all four sides of the wooden crate.

Lift the FF30 away from the pallet by lifting it underneath the machine. Do **not** lift the machine by lifting it in the top plate.

Please check that all ordered items have been received and that no items are damaged during transport. In case of any defects or omissions, please contact WMF or your supplier immediately.

### 2.2 Storing the FF30

Before storing of the FF30 it should be checked if the crate is damaged. In case of long-term storage of the FF30 before installation, the machine must be stored in the crate, and placed in a dry room. The crate is not water resistant.

### 2.3 Mounting of support for inlet and outlet tray

If the inlet tray or outlet tray have been removed during shipping they must be mounted as shown below. Use the supplied bolts and fasten them as shown below.

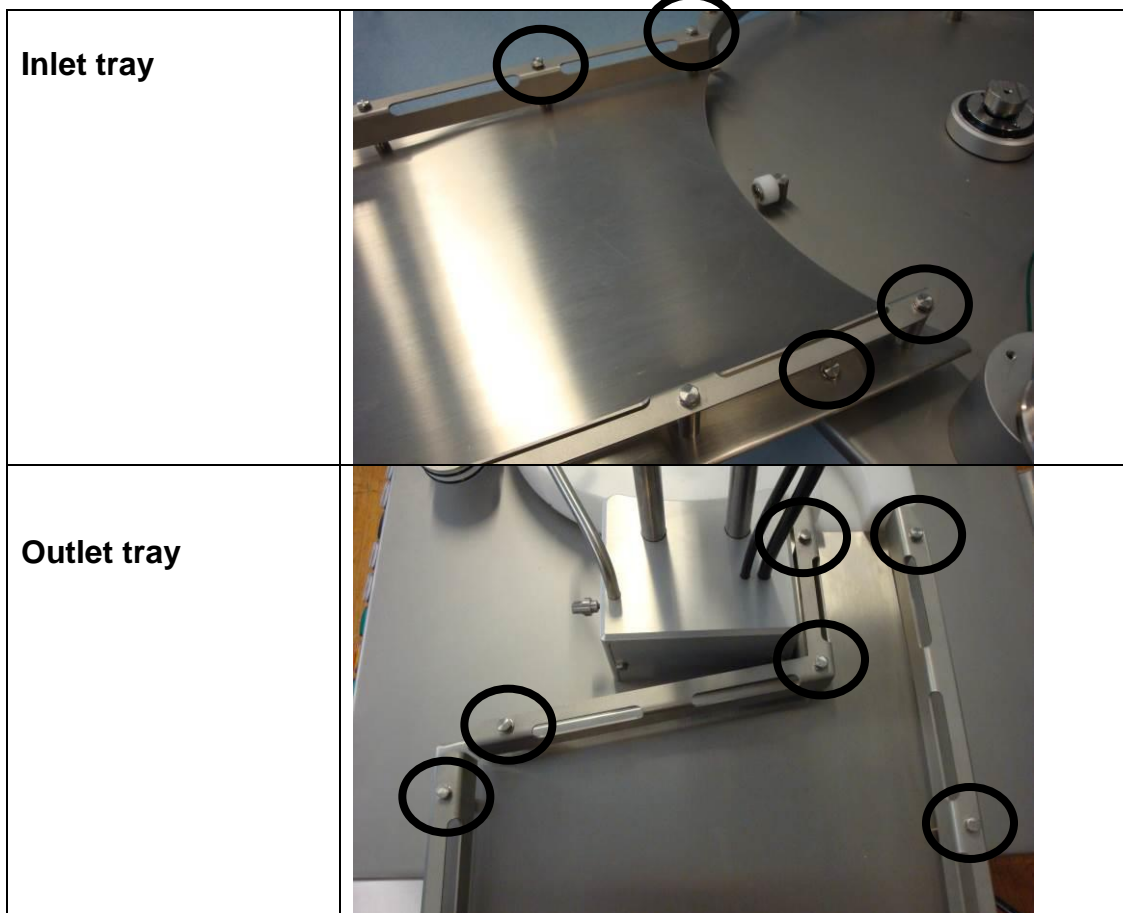

**Accessory for outlet tray**

Smaller bottles can get stuck side by side when moved from the star wheel to the outlet tray.

To prevent that the Bottle guide exit accessory can be mounted / hanged on the outlet tray to narrow down the passage for the bottles.



Bottle guide exit accessory  
34-302-239 – 15 mm  
34-302-346 – 20 mm

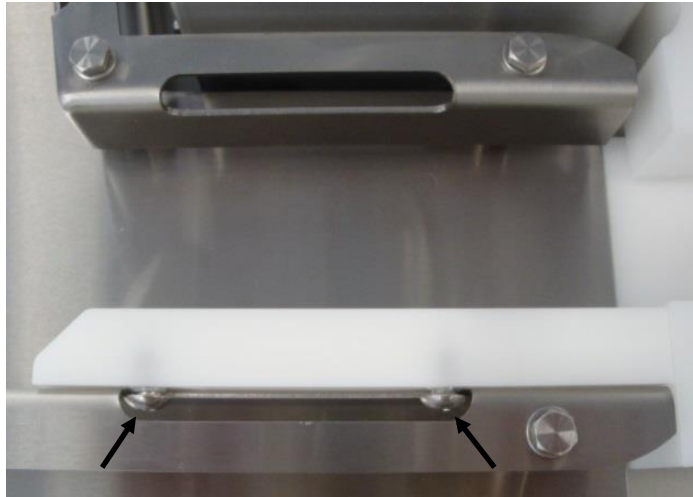

Bottle guide mounted / hanged on the outlet tray guide.

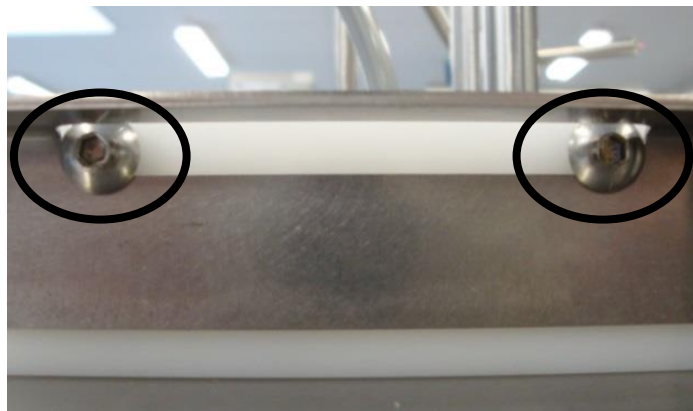

## 2.4 Technical specifications

### 2.4.1 Dimensions

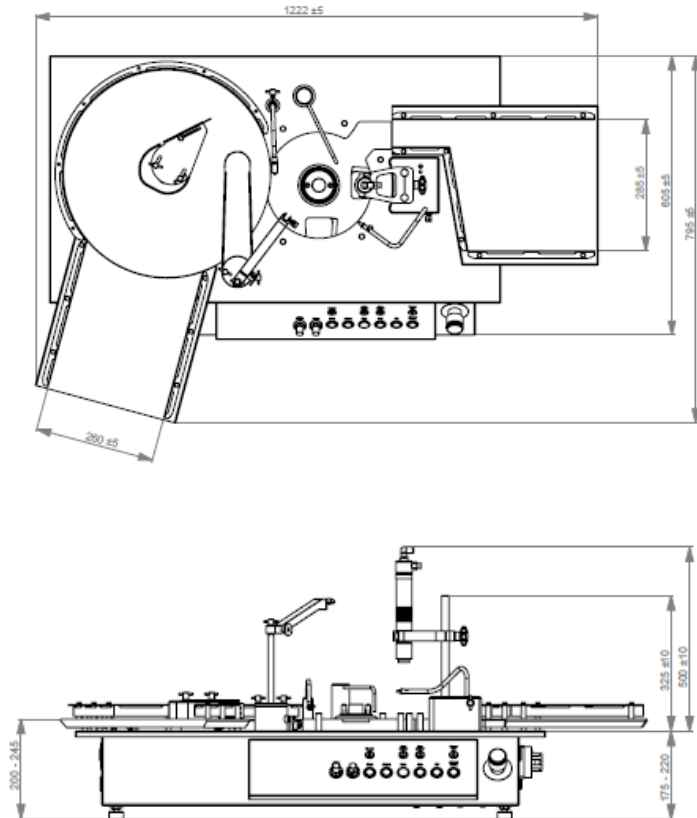

Length: 1230 mm  
 Width: 795 mm  
 Height: max. 730 mm (incl. Feet)



Dimensions: mm / inches

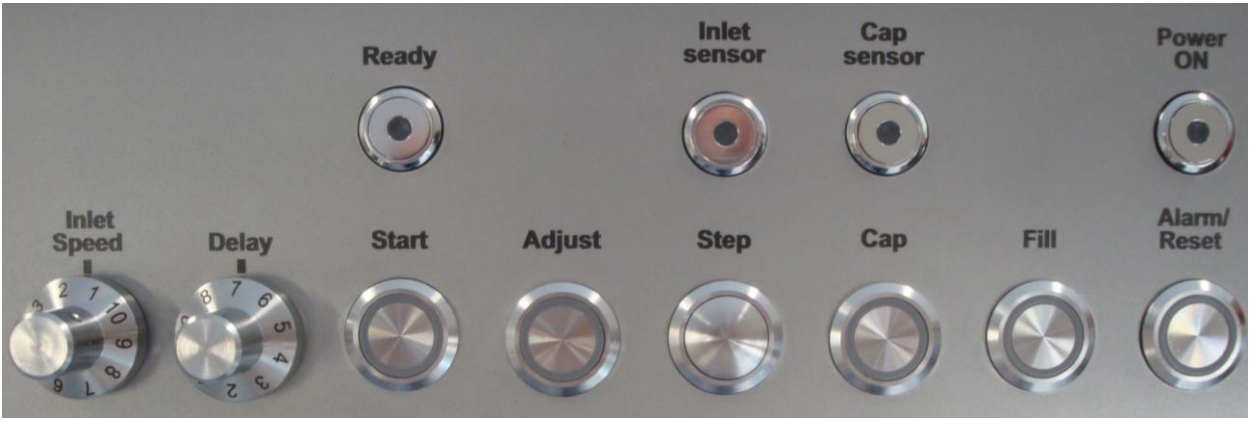

**2.4.2 Buttons / Control panel**

			<p><b>ON/OFF – SWITCH</b> Main switch for the entire FF30</p>
			<p><b>EMERGENCY STOP BUTTON</b> Emergency stop button for the entire FF30 and connected filler</p>
			
<p><b>Power ON</b></p>	<p>Power ON button which lights when power is on.</p>		
<p><b>Cap sensor</b></p>	<p>Button for Cap sensor. Lights when Cap sensor sees cap during adjustment.</p>		
<p><b>Inlet sensor</b></p>	<p>Button for Inlet sensor. Lights when Inlet sensor sees bottle during adjustment.</p>		
<p><b>Ready</b></p>	<p>Ready button which lights when FF30 is ready</p>		
<p><b>Alarm / Reset</b></p>	<p>Push button for cancelling errors. The button flashes if an error occurs.</p>		
<p><b>Fill</b></p>	<p>Enables filling; signal to an external pump. Lights when the filling function is active.</p>		
<p><b>Cap</b></p>	<p>Enables capping. Lights when the capping function is active.</p>		
<p><b>Step</b></p>	<p>Push button. One push activates one step with the star wheel.</p>		
<p><b>Adjust</b></p>	<p>Push button for adjustment mode. Lights when Adjust is active.</p>		
<p><b>Start</b></p>	<p>Push button for starting and stopping production. Lights when Start is active</p>		
<p><b>Delay</b></p>	<p>Potentiometer for adjusting the delay between each indexation. 1 = minimum time (~ fast process of bottles), 10 = maximum time (~ slow process)</p>		
<p><b>Inlet speed</b></p>	<p>Potentiometer for setting the speed of the round table. 1 = slow 10 = fast</p>		

### 2.4.3 Services

All electrical systems are placed in the base cabinet.

Power supply:	100-127 / 200-240 VAC, 50/60Hz Earthed by the main power switch
Consumption:	300 W
Compressed air:	0.6 MPa, clean and dry air
Consumption:	75 L/min at 20 BPM

Note:

Only authorised personnel can gain access to the installations.

The main power cable must be removed completely from power supply before the base cabinet is opened.

### 2.4.4 Bottles, caps and trays

#### Bottle sizes

Diameter	Max Ø50 mm.
Height	Max 110 mm.

#### Cap sizes

Diameter	Max Ø50 mm.
Height	Max 40 mm.

#### Tray size inlet / outlet

	Inlet	Outlet
Length / width*	290 mm / 260 mm	280-320 mm / 285 mm
Height of guide	30 mm	30 mm

\*note – the trays are not rectangular. See picture on the front page.

### 2.4.5 Ingress protection

Ingress protection IP52

### 2.4.6 Weight

Weight: app. 60 kg

### 2.4.7 Materials of construction

- AISI304 stainless steel
- Anodised aluminium
- Polyacetal

### 2.4.8 Fillers

A peristaltic filler or gear filler must be connected to FF30.

Optional fillers when filling are:

- PF7 Peristaltic filler
- 520 Di peristaltic filler
- DF32 Positive displacement filler

## 3 Installation

### 3.1 Connections

FF30 must be placed on a stable and horizontal bedplate.

FF30 and filler must only be connected to the specified power supply stated on the tag next to the power connections, as seen on the pictures below (red circles).

The mains cable (1) is connected to a single-phase power supply with earth.

Compressed air is connected to (2) by use of the supplied quick release clutch.

All exhaust air is collected and exhausted through the exhaust filter (3)

The main cable of the filler is connected to (4) (Max. 4 Ampere)

The filler is connected to (5).

RS485 (6) is used for “remote access” (e.g. during service, or monitoring)

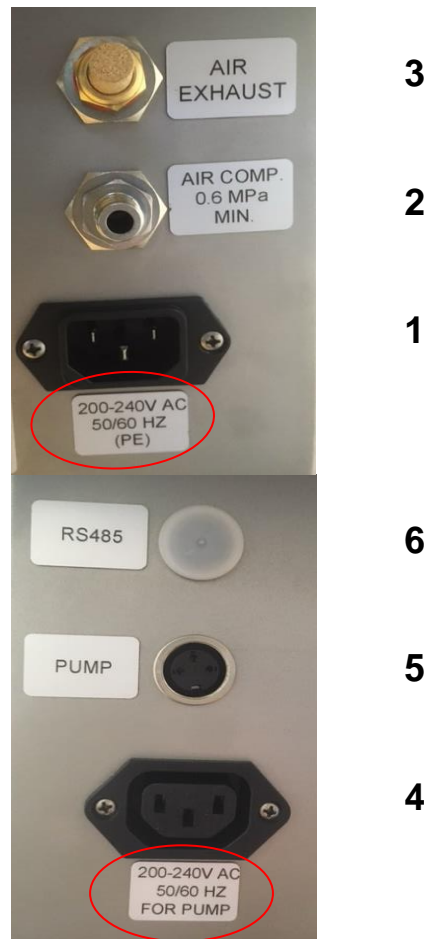

### 3.2 Mounting of format parts

#### 3.2.1 Bottle format parts

A set of bottle format parts consists of 1 star wheel and 3 guides. All 4 are marked with one number which together composes the customised parts for one specific bottle size. The number does not have any reference to the bottle size; it is merely a number which is engraved on the parts to ensure that the matching parts can be recognized.

#### Change of bottle format parts

<p>Loosen the finger screw on the inlet sensor and turn the sensor neck towards round table.</p>	<p>Dismount the bottle ejector by pressing down on it while turning it away from the round table (see red circle on first picture)</p>
<p>Move the star wheel</p>	<p>Finally move the guides one by one...</p>
	<p>When the last guide has been removed another size of format parts can be mounted. This is done the opposite way of the dismounting procedure.</p>

### Adjustment of inlet sensor

The inlet sensor must be adjusted to see the bottle neck when the bottle enters the star wheel. Place a bottle in the first slot of the star wheel. Loosen the sensor arm on the finger screw (yellow circle) and adjust until the light hits close to the side edge of the bottle neck (red circles). Fasten the screw again. The sensor head can be adjusted forwards and backwards by moving the sensor head in the wanted direction (blue arrow and red circles).

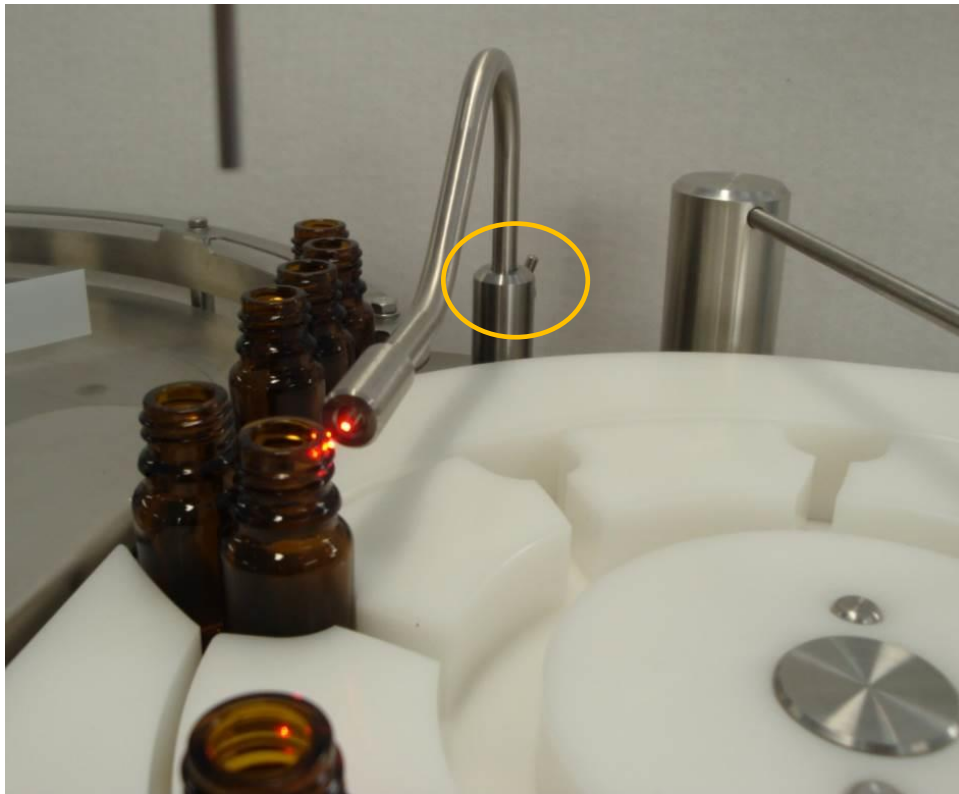



### 3.2.2 Screw cap format parts

Screw cap format parts consist of 1 single capping head. If several sizes of capping heads have been ordered, each size is marked with one number which together with the bottle format parts composes the customised parts for one specific bottle size. The number does not have any reference to the bottle size; it is merely a number which is engraved in the parts to ensure that the matching parts can be recognized. E.g. bottle format parts marked with the number 1 – match the capping head marked with the number 1.

#### Mounting of capping unit

		
<p>Mount the capping unit on the two steel columns</p>		<p>Mount the two hoses for compressed air.</p>

#### Change of capping head

		
<p>Hold the head with one hand</p>	<p>And with the other hand press the quick coupling down</p>	<p>Pull the head down until it is released from the coupling</p>

When mounting another size of capping head, it is not necessary to touch the quick coupling. Just press the head into the coupling until it clicks.

### Adjustment of air pressure regulator on capping unit

In order to perform a correct capping it may be necessary to adjust the air pressure on the capping unit.

This is done via the air pressure regulator, which is placed next to the ON/OFF switch.

<p>Pull the rim of the button outwards to unlock it.</p> <p>Firmer capping: Turn the rim clockwise</p> <p>Looser capping: Turn the rim counter clockwise</p> <p>Press the rim inwards to lock it.</p>	
---	--

Perform some test runs and control if the capping is okay; if not – perform a new adjustment.

Factory settings; see the Format Table.

## 4 Daily Use

### 4.1 Starting-up and running

Installation section must be carried out before this chapter can be performed.

When the main switch is turned, an initial procedure starts and secure that the machine is ready for production. The POWER ON will light if no errors are detected.

In case of error detection during initial procedure the ALARM button will flash.

See section 5 regarding alarms.

#### 4.1.1 Adjusting the round table inner bottle guide

Adjust the inner bottle guide by loosening the finger screws (black circles) and move the entire guide in or out; depending on the bottle size.

Normally the bottles should be stopped by the guide in such a way that only one bottle at a time can pass the space between the inner and outer guides.

For large bottles it might be necessary to adjust the sliding part (yellow circle) of the inner bottle guide further in, allowing two bottles to pass side by side between the inner and outer guides.



For mounting of the flexible tip of the inner guide see: 4.1.3 - Installing Inner bottle guide flexible tip.

#### 4.1.2 Adjusting the inlet guide

Adjust the inlet guide by loosening the finger screws and move it to the right or left, depending on the bottle size.

The bottles should be led to the first position of the star wheel; never to the outside of the star wheel.



Correct adjustment



Wrong adjustment



#### 4.1.3 Installing Inner bottle guide flexible tip.

The moveable part (3) of the inner bottle guide can be extended with a flexible tip (6) to facilitate running with small bottles.

The flexible tip (6) and its mounting screws (7) should be located in the "Accessories bag 66-060-130" which came with the FF30.

Assemble as pictured below and fasten the screws (7).

For adjustment of the Inner Bottle Guide Movable Part see:  
4.1.1 - Adjusting the round table inner bottle guide.

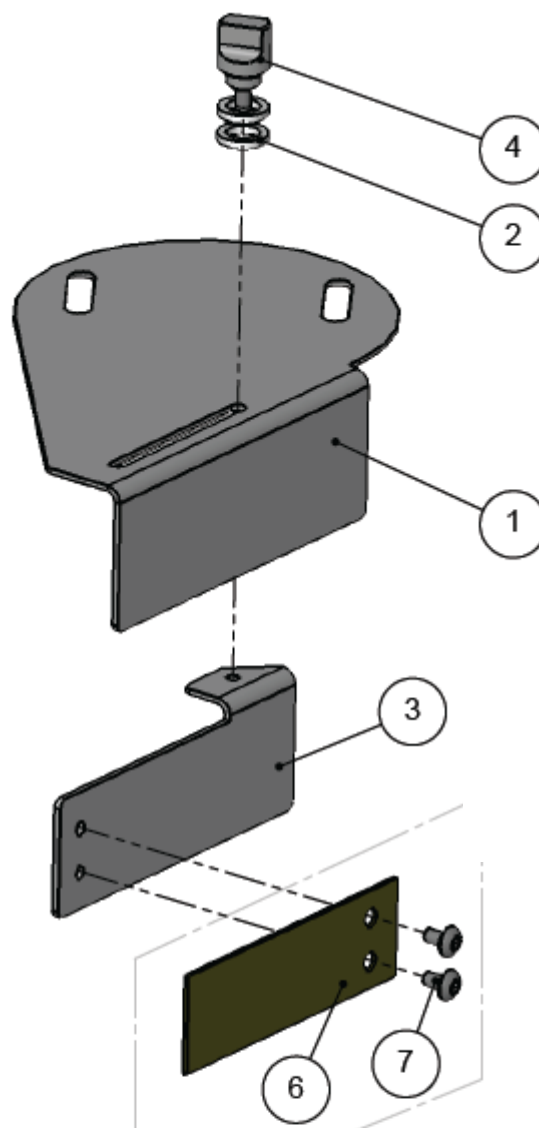

#### 4.1.4 Adjustment of the filling stand

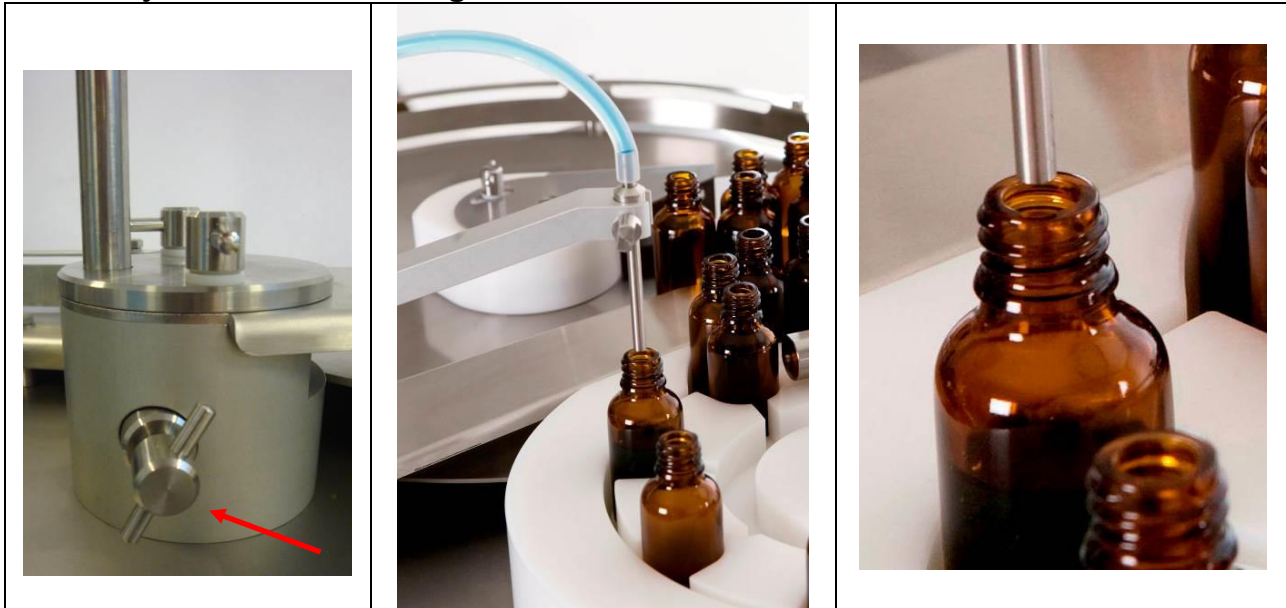

Loosen the finger screw at the bottom of the filling stand.  
Adjust the filling stand and the filling nozzle over the centre of the bottle – over the second bottle in the star wheel.  
The nozzle tip should only be a few millimetres away from the bottle top to avoid squirt of product.

#### 4.2 Adjusting the capping sensor





Place a bottle with a cap in front of the sensor.  
The cap must be placed detachable on the top of the bottle – not screwed.  
Loosen the finger screw of the sensor and adjust until the light is just below the top of the cap and close to the side edge of the cap.

### 4.3 Adjusting the height of capping head

Adjusting the height of the capping head must be repeated until the cap is tightened satisfactorily. A correct capping function is depending on the placement of the capping unit, and the type of cap and bottle.

	<p>Place a bottle with a cap underneath the capping unit. The cap must be tightened into end position. Press ADJUST, to lower the capping unit.</p> <p>Loosen the finger screw on the capping unit and lower it until the capping head is resting on the top of the screw cap. Fasten the finger screw.</p> <p>Now press ADJUST again, and the capping head will return to top position.</p> <p>Loosen the finger screw once more, and lower the capping unit app. 5-10 mm before tightening the finger screw again.</p>
--	--

### 4.4 Adjusting the capping torque

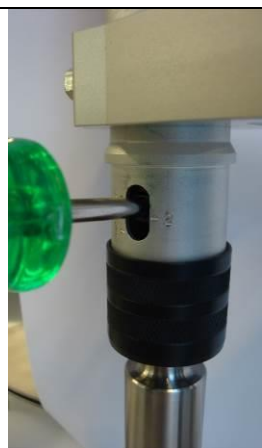
		
<p>Pull the black clutch casing sleeve down.</p>	<p>Turn the capping head until the adjustment lock plate is visible through the slot.</p>	<p>Insert a screwdriver and adjust torque by turning. Increase = clockwise Decrease = counter clockwise</p>

## 4.5 Adjustments

### 4.5.1 Index speed adjustment

Speed is set via the DELAY function. The lower value, the faster the bottles will move from inlet to filling and capping.

- Press ADJUST (the capping machine will enter lower position)
- Set speed on DELAY potentiometer, 1 = minimum time (~ fast process), 10 = maximum time (~ slow process)
- Press START to save the value (note the value)
- Turn DELAY back to 0
- Press ADJUST again to return to normal mode

The value is saved when the machine is turned off.

### 4.5.2 Bottle ejector speed adjustment

Speed is set via the DELAY function. The lower value, the faster the bottles will be pushed onto the outlet tray.

- Press ADJUST (the capping machine will enter lower position)
- Set speed on DELAY potentiometer, 1 = minimum time (~ fast process), 10 = maximum time (~ slow process)
- Press STEP to save the value (note the value)
- Turn DELAY back to 0
- Press ADJUST again to return to normal mode

The value is saved when the machine is turned off.

### 4.5.3 Capping time adjustment

Capping time adjustment is set via the DELAY function. The lower value the adjustment is set at, the shorter time the capping head will use on screwing the cap into place. Note: If the time is too short the cap might not be fastened enough.

- Press ADJUST (the capping machine will enter lower position)
- Set speed on DELAY potentiometer, 1 = minimum time (~ fast), 10 = maximum time (~ slow)
- Press CAP to save the value (note the value)
- Turn DELAY back to 0
- Press ADJUST again to return to normal mode

The value is saved when the machine is turned off.

### 4.5.4 Round table speed adjustment

See section 2.4.2

## **4.6 Production START and STOP**

FF30 is ready for production when:

- bottles are placed on the inlet tray
- the inner bottle guide is adjusted
- the inlet guide is adjusted
- filling stand is adjusted
- the external filler is connected and ready
- capping sensor is adjusted
- height of capping head is set
- the Index speed is set, if necessary
- READY indicator is ON (lights)

Production can begin by pressing START. FILL and CAP must be activated before pressing START. When a bottle is detected at the inlet the star wheel will begin the indexing, and the activated functions start.

The time/pause between 2 indexing cycles can be adjusted via the DELAY function. If a function has a longer cycle time than the setting of the DELAY, the indexing will be halted until all functions have finished the cycle.

### **4.6.1 Manual placing of caps**

Caps are to be applied on the bottles after filling has been performed.

The cap is placed with a small twist to prevent the cap from falling off during the following indexing.

The cap sensor is only active when the CAP button has been activated.

If a bottle enters in front of the sensor without a cap the FF30 will stop. Place the cap manually and press CAP to continue production; or press STEP to end automatic production – the star wheel will now move one position forward.

### **4.6.2 Removing bottles from collection tray**

When the collection tray is full the operator must stop the machine and empty the tray.

When the outlet tray is full the operator can choose to stop the machine and empty the tray or to empty the tray when production is ongoing and the tray is not packed.

## **4.7 Stepping bottles through the FF30**

Pressing the STEP button will perform one indexing; the star wheel will move all bottles one function forward. From inlet to filling > from filling to capping > from capping to outlet.

When pressing STEP, the star wheel and the bottle ejector will move whether a bottle is present or not.

If filling is desired this must be activated manually from the filler.

If the CAP function is ON a cap must be applied to the bottle manually after the filling is performed.

By using the STEP function the star wheel can be emptied at the end of a batch.

If the STEP button is held down constantly the functions continue as long as there are bottles in the star wheel.

## 5 Malfunctioning

The FF30 is equipped with control functions, which will stop the machine in the event of malfunctioning. If a function error is detected, the yellow ALARM/RESET (A/R) button will begin to flash and the FF30 will stop.

### 5.1 Start-up alarms

The alarm number is identified by observing both the A/R button together with the READY indicator. By counting the number of flashes of the A/R button in between each flash of the READY indicator the alarm number can be identified.

Alarm No	Description	Actions
1	Internal RS485 communication failure with Round Table (RT) Controller	Open machine and check fuses, cables etc.
2	RT Controller not READY	Only used with diving nozzle, for the RT controller to be backwards compatible.
3	Capping station not in top position	First check compressed air and air connection. Next open machine and check sensor and mechanical parts
4	Indexing start-wheel is not in HOME position	First check for things obstructing the star wheel movement. Next open machine and check fuses, motor and sensors for motor-controller.

### 5.2 Runtime alarms

Alarm No	Description	Indication	Actions
5	Exchange cycle is not completed.	A/R and START buttons are flashing	<p>Check if something (bottle or cap) is obstructing the star wheel movement, remove the obstacle and press A/R button – depending on the position of the star wheel, the actions are different:</p> <ul style="list-style-type: none"> <li>- Something is stopping the star wheel at the entrance: The star wheel reverses to start position, where the obstacle can be removed. Press the START button to resume production</li> <li>- Something is stopping the ejector arm from pushing out: The ejector arm is returned to the home position. The A/R is still flashing and when pressing the A/R button <u>twice</u> the ejector arm is moved out again to finish the exchange cycle. Press the START button to continue production.</li> </ul>

Alarm No	Description	Indication	Actions
6	Capping cycle is not completed	A/R and CAP buttons are flashing	<p>There are a couple of situations, where this alarm will be initiated:</p> <ul style="list-style-type: none"> <li>- The capping head is obstructed during the downwards movement: The capping head is returned to top position. If the bottle is in the correct position and nothing seems to obstruct the downwards movement, the machine has to be opened to investigate sensors and/or mechanical faults.</li> <li>- The alarm is initiated after the capping is finished: This could indicate to low air-pressure. If this not the case then the machine has to be opened to investigate sensors and/or mechanical faults.</li> <li>- Lack of air pressure</li> </ul> <p>Press the A/R button to reset the alarm and START button to continue production.</p>
7	Cap station (top-sensor) not in top during star wheel movement.	A/R, START and CAP buttons are flashing	<p>Check air pressure, open machine to check Press A/R button the reset the alarm.</p>
8	Adjust cycle is not completed	A/R and ADJUST buttons are flashing	<p>See the alarm description on alarm number 6 as the courses of the alarm are the same. Press A/R button the reset the alarm.</p>
9	N/A	N/A	N/A
10	Round table fault	A/R, START and FILL buttons are flashing	<p>Fault inside machine the round table toothed wheel is not turning; fault must be investigated inside machine: Check toothed belt, fuses and motor.</p>

### 5.3 Runtime warnings

A warning is used to turn the operator's attention to halt situations, which must be solved in order to continue production / running.

Alarm No	Description	Indication	Actions
1	Cap is not on bottle at Cap-detect position.	CAP button is flashing	<p>There are two distinctly different ways of responding to this alarm/warning.</p> <ul style="list-style-type: none"> <li>- Put a CAP on the bottle and press CAP button to continue production.</li> <li>- Press the STEP button. This will end the automatic production (and capping) – the star wheel will move one position forward.</li> </ul>
2	Filler is not starting on start signal	FILL button is flashing	<p>Depending on conditions for the alarm/warning there are the following possible actions:</p> <ul style="list-style-type: none"> <li>- Start the filler manually. e.g. on a PF6 Press GO+DISP+GO The FF30 will then continue and clear the warning.</li> <li>- Stop the automatic mode by pressing either START or FILL buttons. The FF30 will leave fill mode and automatic mode.</li> </ul>

### 5.4 Trouble shooting

Description of fault	Possible cause
The READY indicator does not go ON	<ul style="list-style-type: none"> <li>- Compressed air is not connected</li> <li>- The star wheel is not in "home" position</li> <li>- The ejector arm is not in "home" position</li> </ul>
The star wheel does not index	<ul style="list-style-type: none"> <li>- The bottle inlet sensor does not see the bottle at the inlet.</li> <li>- A workstation has not finished the cycle</li> <li>- The toothed belt needs tension</li> <li>- Check fuses</li> </ul>
External filler does not start when a bottle is present under nozzle	<ul style="list-style-type: none"> <li>- Missing or loose cable from FF30 to filler</li> <li>- The filler is not in "dispense mode"</li> </ul>
Capping station runs even if cap is missing	<ul style="list-style-type: none"> <li>- The cap sensor has been placed too low</li> </ul>
Capping is not complete or torque is inconsistent	<ul style="list-style-type: none"> <li>- Capping head is placed too high</li> <li>- The bottle slips in the star wheel during capping</li> </ul>
The bottle ejector does not move the bottle to the outlet tray	<ul style="list-style-type: none"> <li>- The ejector is not mounted correctly.</li> <li>- The toothed belt needs tension</li> <li>- Check fuses</li> </ul>



## 6 Cleaning

### 6.1 Cleaning Frequency

As FF30 is not in direct contact with the dispensed product, daily cleaning might not be necessary.

Cleaning might be determined by local sop's and cleaning validations; but must never be with detergents more potent than the ones below.

### 6.2 Preparations for cleaning

Before cleaning the machine:

- Turn off the power
- Remove the filling nozzle and the filling tubes

### 6.3 Cleaning Guidance

Correct cleaning of the FF30 is carried out by washing it off with water or detergents, using a lint-free firmly wrung cloth or lint-free paper towel; subsequently the machine is wiped off with a dry cloth.

### 6.4 Detergents or cleaning agents

Normal cleaning agents such as tepid/medium hot water, ethyl alcohol (ethanol) 70% and may be used all over the machine.

The FF30 consists of stainless steel and anodized aluminium, and can be cleaned in several ways:

Cleaning of parts made of:	Can be autoclaved	Can be cleaned with ethyl alcohol 70%	Can be cleaned with water and afterwards wiped off with dry a cloth
Stainless steel AISI304	X	X	X
Anodized aluminium	X	X	X
Polyacetal (POM)		X	X
Nylon (Compressed Air tubes)			X
Optical sensors*		X	X*

*\*Optical Sensors can be cleaned with alcohol, but over time this can cause a milky surface. Either avoid cleaning the sensor optics with solvents or be sure to wipe them immediately afterwards with a soft dry cloth.*

*Recommendation:*

*Keep a log on the cleaning in order to keep track of the activities.*

## 7 Maintenance & service

### 7.1 Maintenance

Note: Maintenance of drive systems includes accessing the base cabinet and should be carried out by technical staff, only.

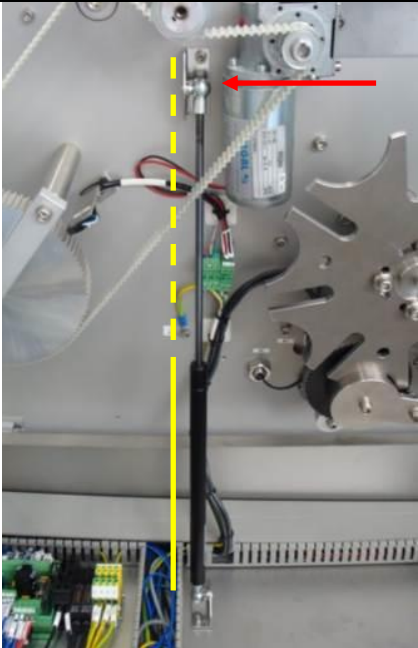
	
<p>The base cabinet is opened with a key. Key holes are placed on each side of the machine.</p>	<p>Secure the opened top plate with the folding out rod.</p>

#### 7.1.1 Tension of toothed belt

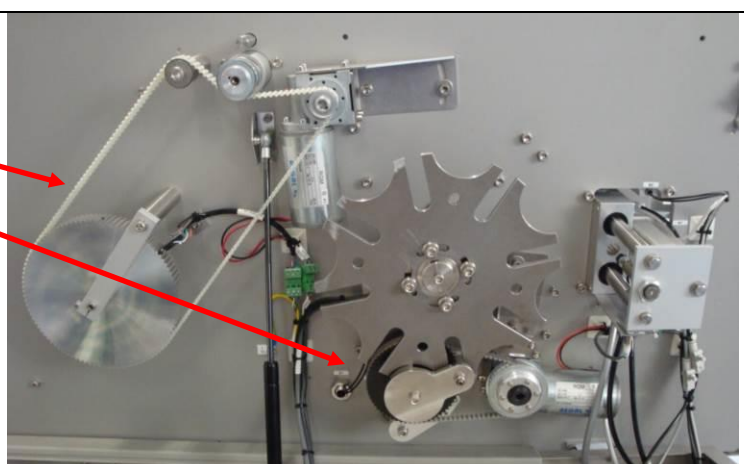
<p>Both the round table and the star wheel are driven by a toothed belt.</p> <p>Normally these will not need tension, but should be checked yearly.</p>	
---	--

### 7.1.2 Capping unit

The capping air motor requires lubrication in order to function optimal. It is recommended to supply the air inlet with one drop of turbine oil before and after operation.

Recommended oil: Rocol Foodlube Multi-Lube with PTFE.

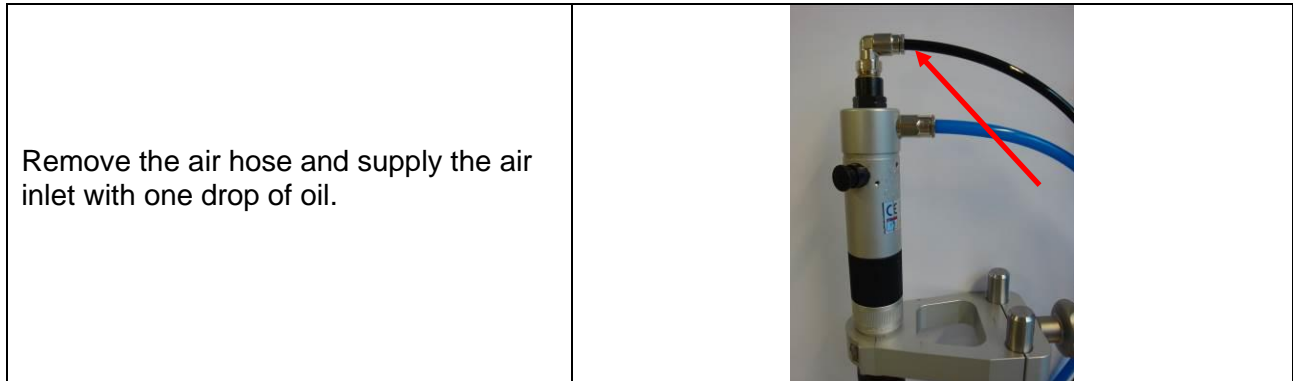

### 7.1.3 Star wheel and bottle ejector

The drive systems of the star wheel and the ejector arm needs regular lubrication.

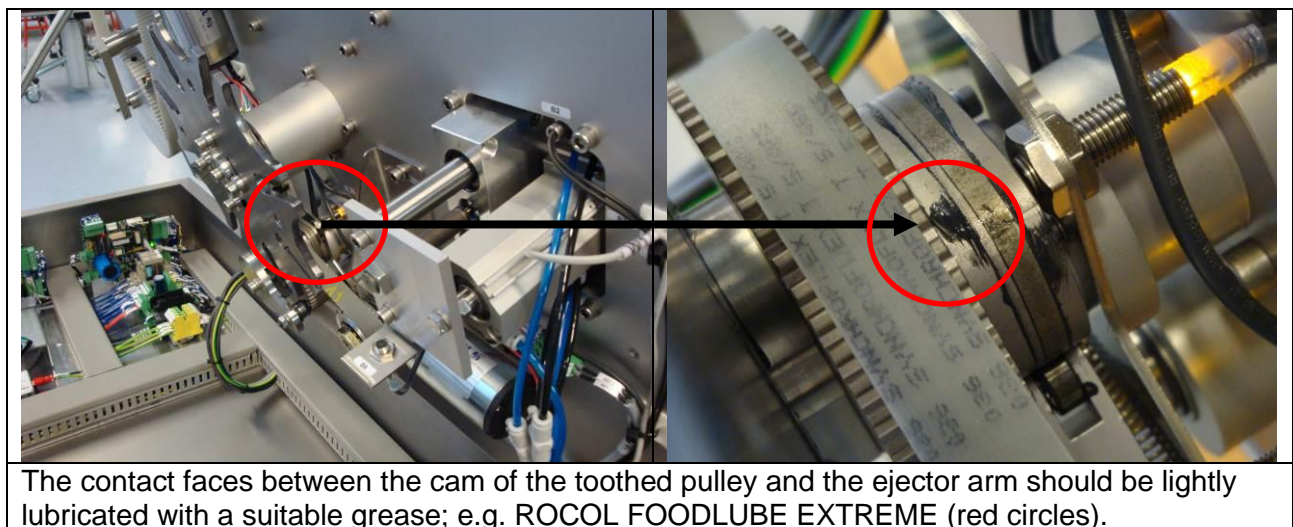
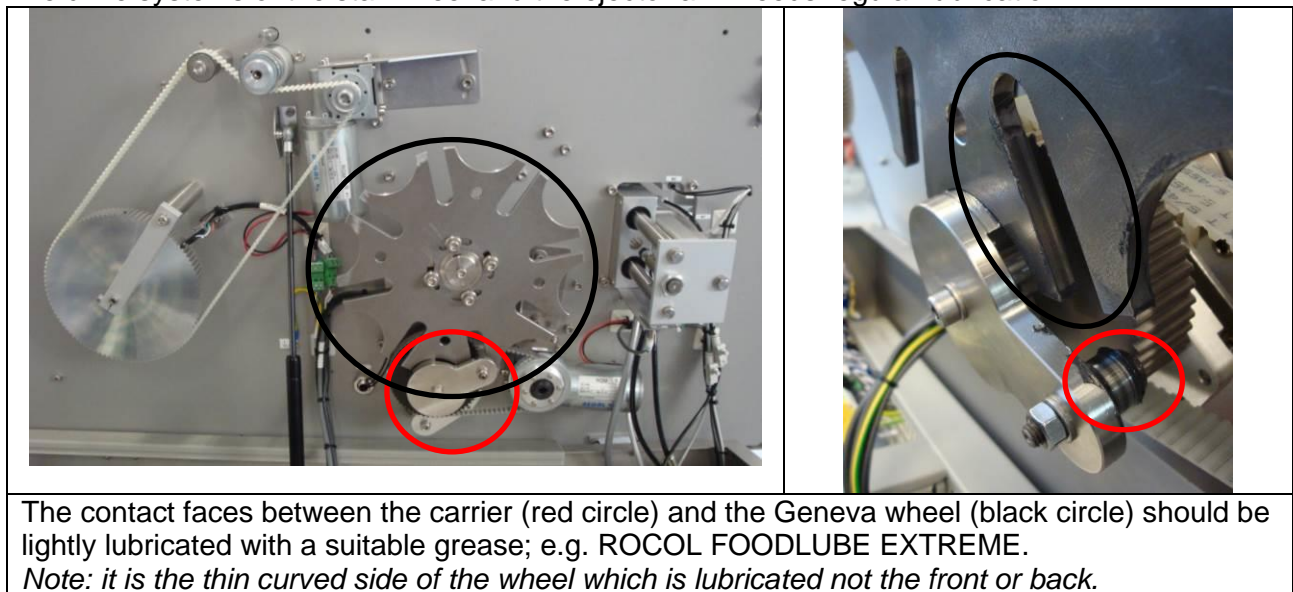

## 7.2 Service

Should service be needed, please contact W-M Flexicon or your local supplier.

### 7.2.1 Safety coupling

The safety coupling needs to be replaced.

The safety coupling is a safety component and **must be replaced every 3 years.**



## 7.3 Methods and frequency of inspections for safety functions

Safety functions should be tested once a year:

- Emergency STOP button  
When pressed the entire FF30 and filler is shut down.

Keep a log and read the previous log recordings to present an overview of the machines state. After testing the safety functions the results must be recorded in the log.

## 8 Change of voltage

The FF30 can be converted to accept another supply voltage.

The conversion can be made inside the machine by moving the cables of the transformer clamps.

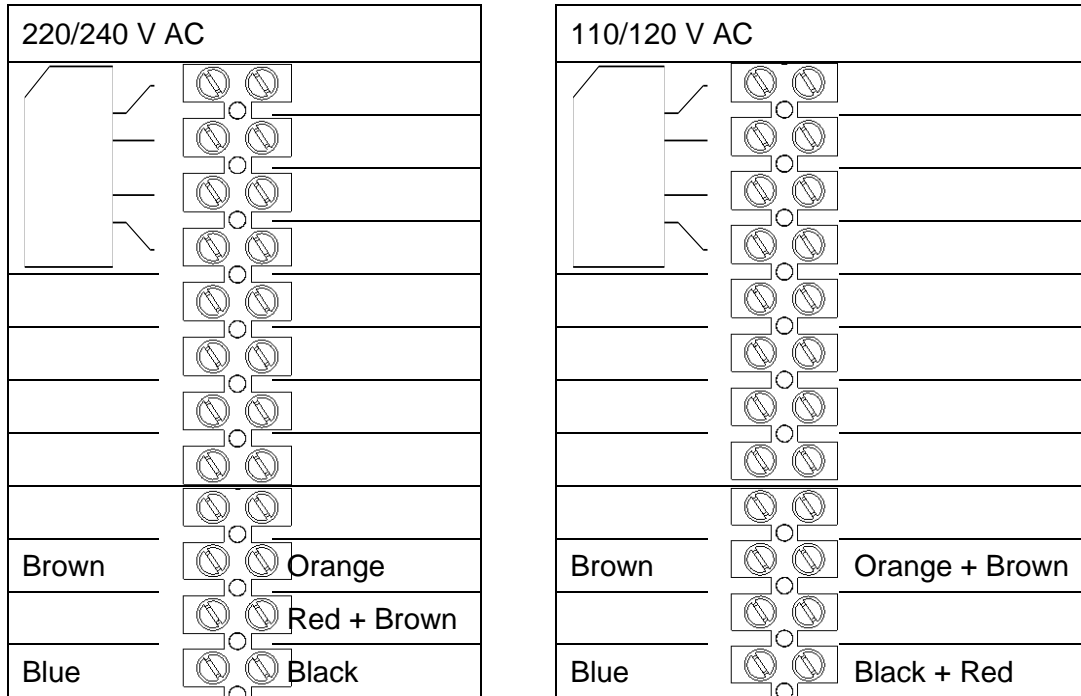

**Change of voltage**

FF30 can be changed over to different main powers.

The changeover is carried out inside the machine by moving the wires to the positions indicated in picture above.